

# BEAST PRO

## 200A & 300A

ZTW Beast series sensored/sensorless brushless ESC for 1:5<sup>th</sup> scale car.

Thank you for purchasing the ZTW Brushless Electronic Speed Controller (ESC). The ZTW BEAST PRO Series 200A, 300A ESC are high quality and high performance ESC which can be used for 1:5<sup>th</sup> scale truck and buggies. Beast PRO series ESC are well designed and tested and fine-tuned by the experienced driver proven to be a reliable quality ESC. On top of this, we make it more resistant to water. You can run your vehicles through the morning dew, down the muddy road, across the soggy snow or just about anywhere else you'd be interested in running. In order to operate this ESC properly please read this manual thoroughly before use. ZTW Model have no control over the correct use, installation, application or maintenance of these products, thus no liability shall be assumed nor accepted for any damages, losses of costs resulting from the use of this item. Any claims arising from the operating, failure or malfunction etc. will be denied. We assume no liability for personal injury, property damage or consequential damages resulting from our product or our workmanship. As far as is legally permitted, the obligation for compensation is limited to the invoice amount of product in question.

### Features

- Enhanced throttle response, excellent acceleration, linearity and driveability.
- Using the advanced PC interface allows you to set up, program or update the firmware.
- Fully programmable via LCD program card, PC interface .
- Adjustable BEC output 6.0V/7.4V, up to 8A current output.
- Multiple protection features: Low voltage cut-off protection, over-heat protection and throttle signal loss protection.
- Double fan cooling system:one outside, one inside.

### Specification

	1:5 Beast Pro 200A 8S	1:5 Beast Pro 300A 12S
Continuous Current	200A	300A
Burst Current(10s)	1300A	1800A
BEC	6.0V/7.4V Adjustable/8A	6.0V/7.4V Adjustable/8A
Battery NiXX/Lipo	8-24NC/3-8SLipo	18-36NC/6-12SLipo
Width	55mm	74mm
Length	90mm	115mm
Height	50mm	78mm
Weight	407g	500g
Programmable	Yes	Yes
Suitable car	1:5 <sup>th</sup> Buggy/Truck	1:5 <sup>th</sup> Buggy/Truck
Suitable car weight	<13kg	<15kg
Waterproof	Yes	Yes

### Initial Installation Pro Line ESC

Verify each wire is connected correctly per the diagram below.

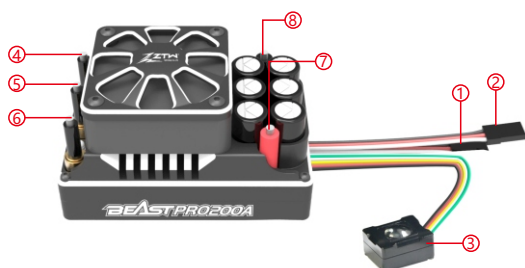

- ① (Short) Program wire
- ② (Long) Singal wire
- ③ Switch
- ④ Motor wire A
- ⑤ Motor wire B
- ⑥ Motor wire C
- ⑦ Power wire(+)
- ⑧ Power wire(-)

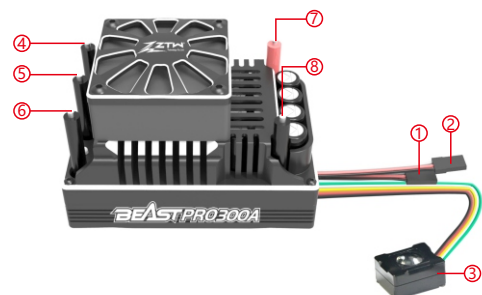

- ① (Short) Program wire
- ② (Long) Singal wire
- ③ Switch
- ④ Motor wire A
- ⑤ Motor wire B
- ⑥ Motor wire C
- ⑦ Power wire(+)
- ⑧ Power wire(-)

## Sensored Mode

When using a Sensored Brushless motor, the Blue motor wire (A), Yellow motor wire (B) and Orange motor wire (C) of the ESC must be connected with the Sensored motor wire terminals (A,B,C) respectively. It is necessary to connect the Sensor wire to the "Sensor" socket on the ESC. Do not change the sequence of the wires.

## Sensorless Mode

When using a Sensorless Brushless motor, the Blue motor wire (A), Yellow motor wire (B) and Orange motor wire (C) of the ESC must be connected with the Sensorless motor wire terminals (A,B,C) respectively. Do not change the sequence of the wires.



Note: If the motor operates in reverse rotation, this can be changed in the programming settings.

## Connection to Rx

White wire RX-Signal  
Red wire RX+6.0V  
Black wire RX-



## LED Indication

Function	LED	LED Status
Low voltage of the battery	Red LED	Blinking
Over-heat of the ESC and motor(95°C)	Blue LED	Blinking
Sensored Mode	Red and Blue LED	ON
Sensorless Mode	Blue LED	ON

## Throttle Range Calibration

### Step one



Hold the switch

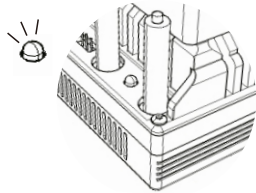

The red and blue are on solid

2 Seconds

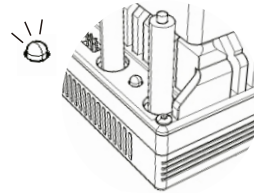

The red off blue on solid

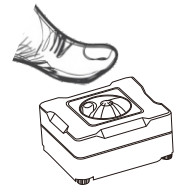

Release the switch

### Step two

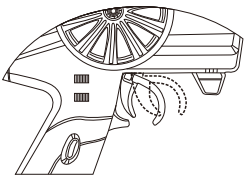

Pull trigger to full throttle



Red led blink for 3 seconds then go on solid, motor "~beep~"

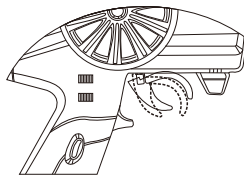

Push trigger to full brake



Blue led blink for 3 seconds then go on solid, motor "~beep~beep~"

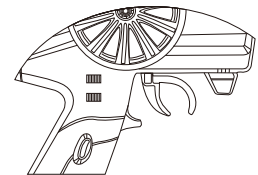

Release trigger to neutral position

### Step three

Red,blue Led blink for 1 second then go solid, motor "~beep~beep~beep~"

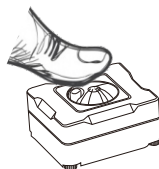

Holding the "Switch" button over 2 seconds will turn off the ESC

## Programmable Item and Default Settings

Programmable Items	Programmable Value								
	1	2	3	4	5	6	7	8	9
Cut-off Voltage	2.6V/cell	2.8V/cell	3.0V/cell	3.2V/cell	3.4V/cell	NO-cut off			
Running Mode	Forward w/o Reverse	Forward with pause then Reverse	Forward/Reverse						
Motor timing	Very Low	Low	Normal	High	Very High				
Initial Acceleration	Low	Medium	High	Very High					
Throttle percent Reverse	20%	30%	40%	50%	60%	70%	80%	90%	100%
Throttle Limit	0%	20%	30%	40%	50%	60%	70%	80%	90%
Percentage Braking	10%	20%	30%	40%	50%	60%	70%	80%	100%
Percentage Drag Brake	0%	4%	8%	12%	15%	20%	25%	30%	
Motor Rotation	Normal	Reverse							
Neutral Range	2%	3%	4%	5%	6%	10%			
BEC	6.0V	7.4V							



Note: Items above Colored are default settings.

## Cutoff Voltage

- **Automatically detect the number of the cells.**

According to the type of your batteries, set up the type of the batteries and Low Voltage Cutoff Threshold via PC software or program card. The ESC can detect the Voltage of the battery anytime and will lower the output power once the Voltage of the battery is lower than the preset Low Voltage Cutoff Threshold.

- When using NiMH or NiCd batteries you do not need to set a cutoff voltage to protect the batteries. If you are using more than 6-cell NiMH or NiCd batteries, you must adjust the cutoff voltage, for example if you are using an 8-cell pack of NiMH batteries you would use a cutoff of 5.6V volts (8 x 0.7V = 5.6V). When the voltage of the batteries packs is within 8.4~12.6V, the ESC will automatically identify 3S LiPos. When the voltage of the batteries packs is less than 8.4V, the ESC will automatically identify 2S LiPos. When the voltage of the batteries packs is within 8.4~16.8V, the ESC will automatically identify 2~4S LiPos. When the voltage of the batteries packs is within 21~25.2V, the ESC will automatically identify 5~6S LiPos.
- Customized Voltage Cutoff (for NiMH or NiCd Batteries) you can select a starting cutoff voltage of 4, 5, 6, 9 or 12 volts. Then using the up/down to the right of the voltage you can increase the voltage stepping up 0.1V between the selectable settings.
- When using any Lithium batteries, they must not be discharged to less than 3.0V per cell.

## Running Mode

- **Forward w/o Reverse**

This is a Race setting – Reverse is disabled.

You will find in racing, most tracks will not allow racing with reverse enabled.

- **Forward with pause then Reverse: (DEFAULT)**

General bashing around (FUN) or racing if reverse is allowed for the event. The Electronic Speed Controller requires 2 seconds of continuous neutral from the transmitter prior to allowing reverse to operate.

Note: There is automatic protection within the ZTW ESC. Only after you have stopped and returned the trigger to neutral will reverse become available. If while traveling in reverse, pull the trigger to go forward. This is to help prevent serious damage to the drive train.

- **Forward / Reverse**

If the option is activated, the RC car could go forward and backward, but couldn't brake.

- **ESC – reverse operation**

Should you get into a situation that requires reverse, after you have applied any brakes you may have needed, return the throttle trigger to the neutral position. Wait a moment or two and then push the trigger forward for reverse.

## Motor Timing

This option affects the power band and efficiency (run time) of an electric motor. The default is "Normal" and is a good starting point to deliver power and provide good run time.

- **Very Low:** Provides maximum efficiency with less power. Higher timing produces significantly more power but at the expense of efficiency (less run time) and typically the motor will generate more heat. Each brushless motor will respond to timing differently. Good for running around on paved, or harder surfaces, and racing with high KV rated or low-turn motors
- **Low:** Provides power for running through soft surfaces, having fun and longer run time.
- **Normal:** (Default) Good mix of power and efficiency using any motor.

- **High:** More power than efficiency so run time will reduce, and you should be monitoring motor heat. The higher KV or lower turn motors will generate heat quickly using this setting. A safe high temperature range is 165F to 180F (74° – 82° Celsius), going higher may damage your motor.
- **Very high:** This is maximum power and must be used with caution.



**Note :** Any motor has the potential to over-heat in this setting. Frequently check the motor temperature and make sure you're not operating higher than 165° and 180° Fahrenheit (74° – 82° Celsius), which may damage your motor, or damage your Electronic Speed Controller (ESC).

## Initial Acceleration

Use this to limit the initial power that is sent to the motor when starting from a complete stop. Using the low option, the vehicle will launch very slowly and provide the longest run times. When using the HIGH choice, you will have wheel-spinning acceleration at the cost of run time. This is also very tough on the batteries as the amperage draw can be very high. If your vehicle cuts out, hesitates or loses radio control, you should consider setting this at a lower value.

- **Low:** Using this option will provide longer run times and is easiest on the batteries. It is a good choice for beginners.
- **Medium:** Medium requires more from your batteries, and is good for low traction surfaces.
- **High:** This option will provide full acceleration and requires stout batteries to supply the load required in this setting.
- **Very high:** This option will provide full acceleration and requires stout batteries to supply the load required in this setting.

## Throttle Percent Reverse

Use this to limit the power available using reverse throttle. The lower the percent or level the less speed will be available in reverse. 20%, 30%, 40%, 50%, 60% (Default), 70%, 80%, 90%, 100%

## Throttle Limit

Use this to limit the power available using forward throttle. The lower the percent the less forward throttle speed will be available. 0% (Default), 20%, 30%, 40%, 50%, 60%, 70%, 80%, 90%

## Percentage Braking

Gives you the ability to have full control over the amount of brake your vehicle will have. 10%, 20%, 30%, 40%, 50% (Default), 60%, 70%, 80%, 100%

## Percentage Drag Brake

0% (Default) 4%, 8%, 12%, 15%, 20%, 25%, 30%

The drag brake function provides the driver a set percentage of brake when you have the transmitter resting in neutral. This will create the "feel" of a brushed motor. Drag brake are used in racing to slow a vehicle as you let off approaching a corner versus the driver having to push the brake at every corner.

Try working with this to get a sense of how you might use this for your track. If you are running on a high traction track with tight corners, a stronger setting should work best. If you are running in an open area, you will find a smaller percentage will result in better control. If you are running in dusty or slippery surfaces, you will more than likely want to use the lowest option.

## Motor Rotation

Normal (default), Reverse

## Neutral Range

This setting adjusts the amount of "Deadband" off neutral on the throttle trigger. This is in Milli-Seconds (MS) and is the amount of neutral when you pull the trigger. The smaller the value the less "Deadband" or movement is required off-center for the ESC to begin throttle functions.

Using a higher value for this setting will provide a wider Deadband.

2%, 3%, 4% (Default), 5%, 6%, 10%

## BEC Output

6.0V (Default), 8.4V

## ZTW LCD Program Card

LCD program Card Can be used as follows:

- Working as an individual device to set the parameters of ESC.
- Working as an USB adapter to link the ESC with PC, to update the firmware of ESC and set the parameters of ESC on PC.

Specification:

Dimension	Weight	Power supply
91mm*54mm*18mm (L*W*H)	68g	DC 5.0V~12.0V

How to connect the LCD program card:

1. Disconnect the battery from the ESC;
2. Disconnect the signal cable of the ESC from the receiver; then plug it into the socket marked with (⚡⊕⊖)
3. Connect the battery to the ESC and turn on the ESC.
4. ZTW Version/Date will be displayed on the LCD screen when ESC is connected, then press any buttons "Ready to connect ESC" will be showed on the LCD Screen., this means that connection between LCD and ESC is established.

If the data connection between LCD and ESC is failed, the LCD Screen is always showing (Ready to connect ESC); Please check if signal wire is connected correctly; if not repeat step1-3.

5. If the connection is established successfully, the first programmable item will be displayed on LCD screen. It's ready to set the parameters now.

⚠ **Note1:** Please strictly connect according to the above sequence. The sequence of step 2 and step 3 can not be reversed. Otherwise, the LCD program card can not work properly.

⚠ **Note2:** A separate power is needed if the ESC is without BEC.

Connect an additional power (5-12V) to the socket marked with (⊕⊖) on the left of the LCD program card for power supply. Please be sure that the polarity is connected correctly. Plug the signal wire into the socket marked with (⌚⊕⊖) first. Then connect an additional power (5-12V) to the socket marked with (⊕⊖). Then switch on the ESC. If the sequence is wrong, LCD will not work properly.

⚠ **Note3:** The power supply should be lower than 12V, or the program card will be damaged.

Operation:

a) Working as an individual device to program the ESC

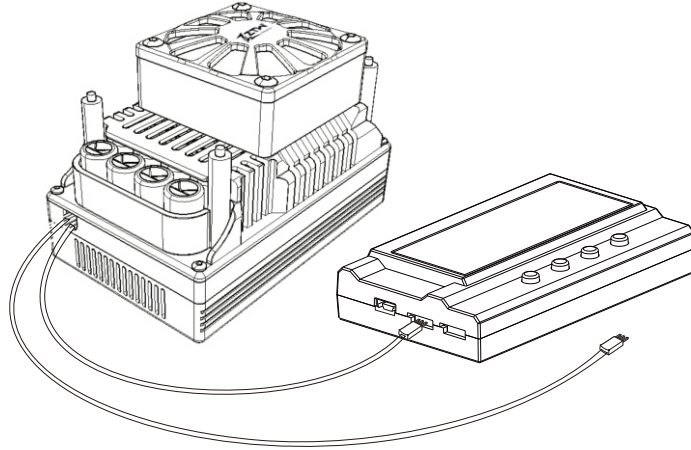

“Menu”: Change the programmable items circularly;

“Value”: Change the parameters of each programmable item circularly

“Reset”: Return to the default settings.

“OK” : Save the current parameters into the ESC. If you don't press “OK” button, the customized settings will not be saved and updated into the ESC. If you just press “Menu” button, the customized settings are just saved into the program card, not into the ESC.

E.g. : Firstly, enter the interface of a customized programmable item (e.g.: cut-off voltage 3.2/cell);

Secondly, press “Value” button to select the parameters;

At last, press “ok” button to save the parameters in the ESC.

b) Working as an USB adapter to link the ESC with a PC to update the firmware of ESC and set the parameters on PC.

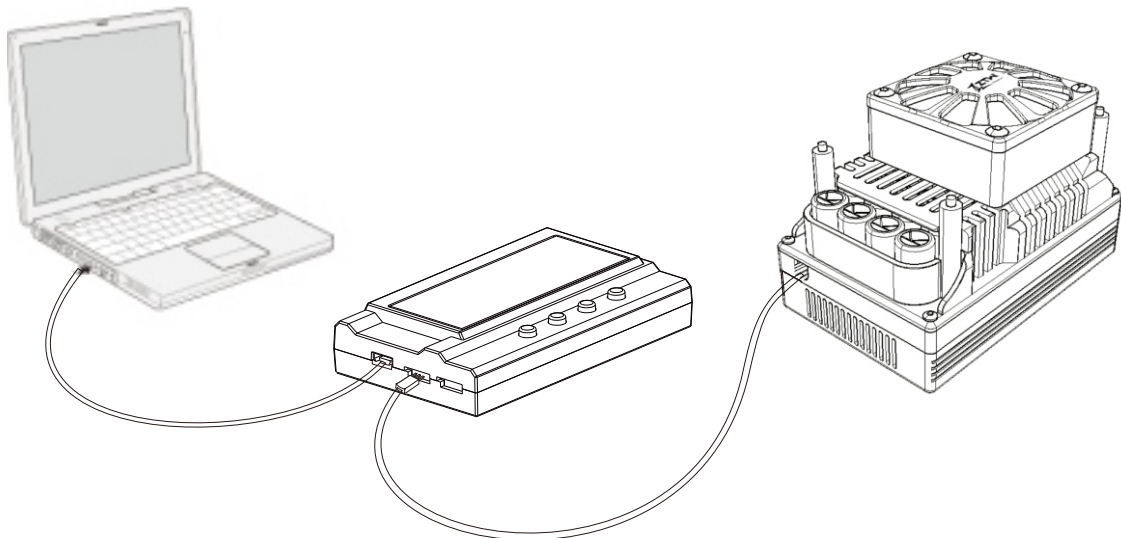

**SHENZHEN ZTW MODEL SCIENCE & TECHNOLOGY CO., LTD**

ADD: 2/F, Block 1, Guanfeng Industrial park, The second Industrial Estate, Jiuwei new village, Xixiang, Baoan, Shenzhen, China, 518126

TEL: +86 755 29120026, 29120036, 29120056

FAX: +86 755 29120016

E-mail: sales@ztwoem.com / support@ztwoem.com

Web: www.ztwoem.com