



# Ghostwriter Super Chipmunk

81" wingspan ARF 35-40cc

Code : SEA397

## ASSEMBLY MANUAL

"Graphics and specifications may change without notice".



### Specifications:

Wingspan-----	81 in-----	205.8 cm.
Wing area-----	1056.2 sq.in-----	68.1 sq.dm.
Weight-----	15.4 lbs-----	7.0 kg.
Length-----	68.4 in-----	173.7 cm.
Engine-----	35 - 40cc	
Motor-----	Motor 180/195kv / ESC 80A - 120A/ Lipo 10 - 12s 3300 - 4200mAh.	
Radio System-----	7 channels with 8 digital servos.	



## INTRODUCTION

Thank you for choosing the **Ghostwriter Super Chipmunk 81" wingspan ARF 35-40cc** ARTF by **SG MODELS**. The **FGhostwriter Super Chipmunk 81" wingspan ARF 35-40cc** was designed with the intermediate/advanced sport flyer in mind. It is a semi scale airplane which is easy to fly and quick to assemble. The airframe is conventionally built using balsa, plywood to make it stronger than the average ARTF, yet the design allows the aeroplane to be kept light. You will find that most of the work has been done for you already. The motor mount has been fitted and the hinges are pre-installed. Flying the **Ghostwriter Super Chipmunk 81" wingspan ARF 35-40cc** is simply a joy.

This instruction manual is designed to help you build a great flying aeroplane. Please read this manual thoroughly before starting assembly of your **Ghostwriter Super Chipmunk 81" wingspan ARF 35-40cc** Use the parts listing below to indentify all parts.

## WARNING

***Please be aware that this aeroplane is not a toy and if assembled or used incorrectly it is capable of causing injury to people or property. WHEN YOU FLY THIS AEROPLANE YOU ASSUME ALL RISK & REPONSIBILITY.***

If you are inexperienced with basic R/C flight we strongly recommend you contact your R/C supplier and join your local R/C model Flying Club. R/C Model Flying Clubs offer a variety of training procedures designed to help the new pilot on his way to successful R/C flight. They will also be able to advise on any insurance and safety regulations that may apply.

## KIT CONTENTS



## KIT CONTENTS

### SEA397 Ghostwriter Super Chipmunk 81" wingspan ARF 35-40cc.

1. Fuselage
2. Wing set (2)
3. Tail set (2)
4. Canopy
5. Cowling
6. Wing tube
7. Pilot
8. Landing gear
9. Fuel tank
10. Tail wheel
11. Pushrod set
12. Ep Motor box
13. Spinner

## ADDITIONAL ITEMS REQUIRED

- 35-40cc gasoline engine.
- Computer radio 7 channel with 8 servos.
- Glow plug to suit engine.
- Propeller to suit engine.
- Protective foam rubber for radio system.

## TOOLS & SUPPLIES NEEDED

- Thin cyanoacrylate glue.
- Medium cyanoacrylate glue.
- 30 minute epoxy.
- 5 minute epoxy.
- Hand or electric drill.
- Assorted drill bits.
- Modelling knife.
- Straight edge ruler.
- 2mm ball driver.
- Phillips head screwdriver.
- 220 grit sandpaper.
- 90° square or builder's triangle.
- Wire cutters.
- Masking tape & T-pins.
- Thread-lock.
- Paper towels.

## LED LIGHT SET

Please see pictures below.

1.

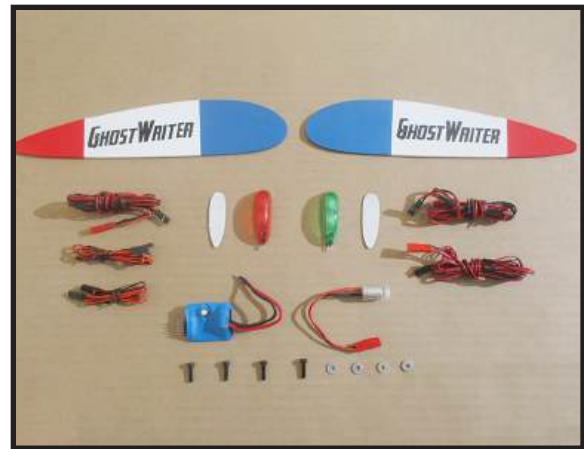

One white light and one green light for the right wing tip, one white light and one red light for the left wing tip.

2.

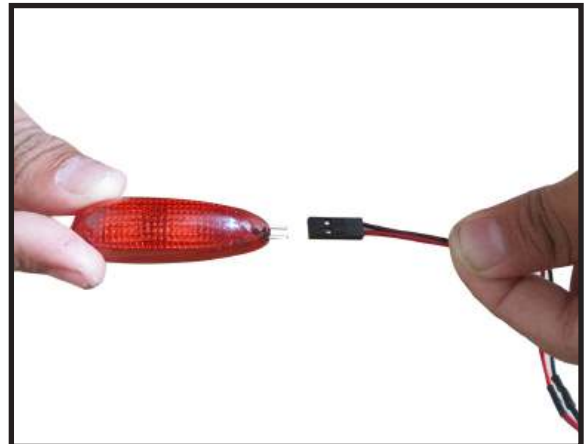

3.



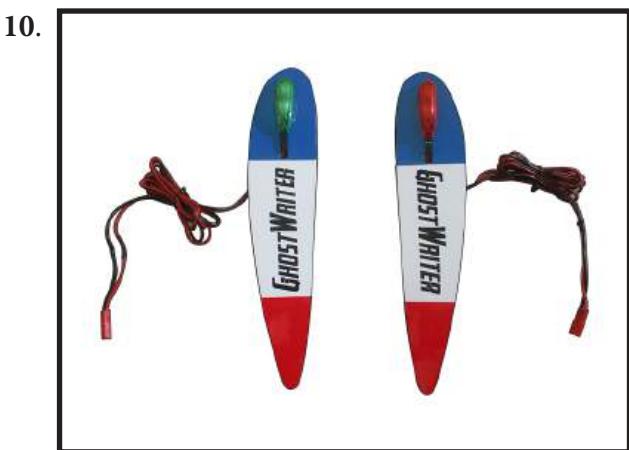
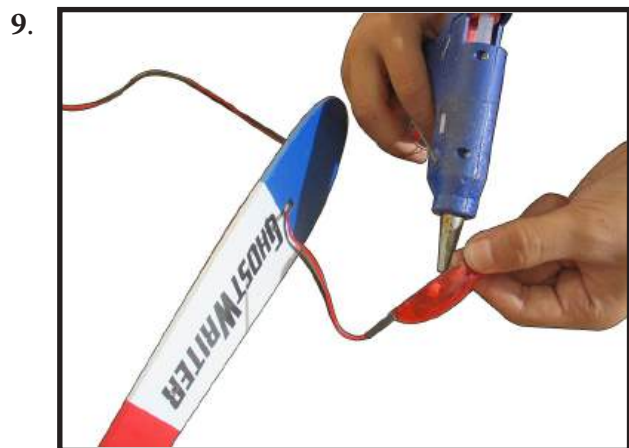
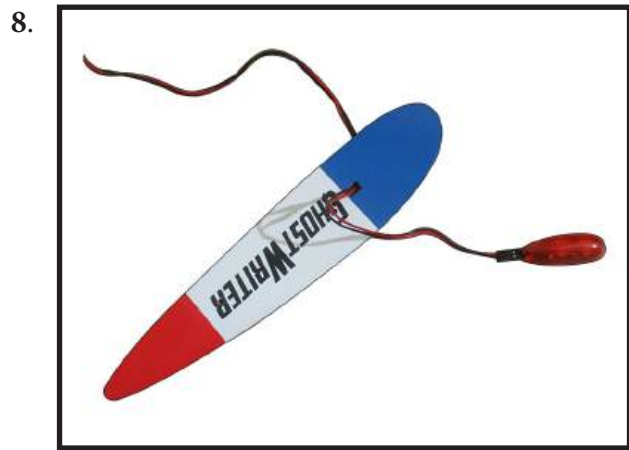
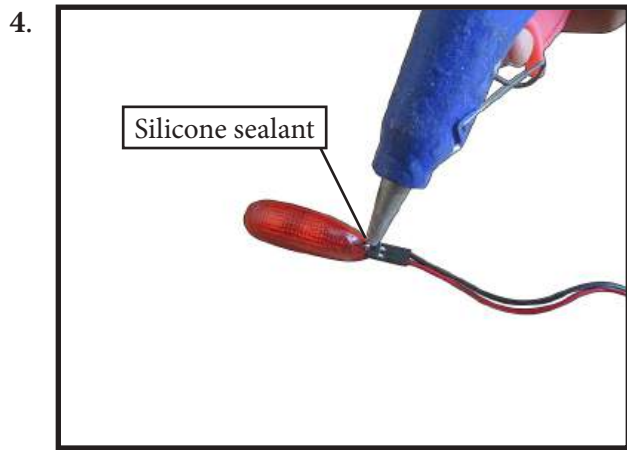

12.

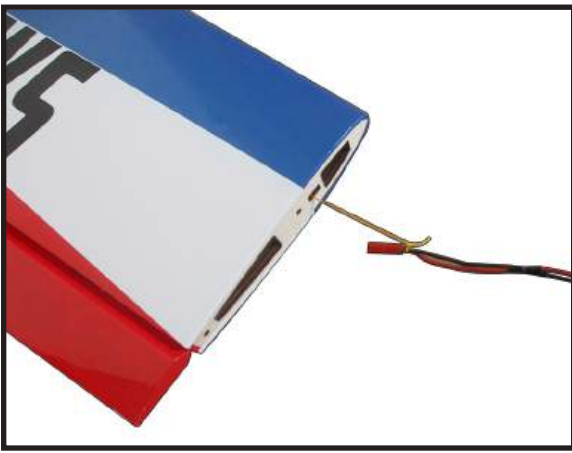

13.

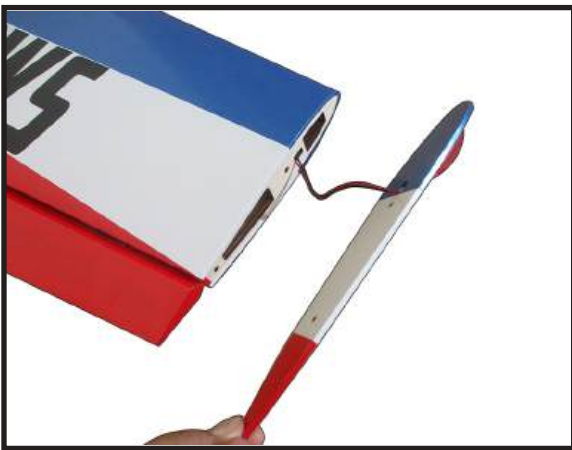

14.

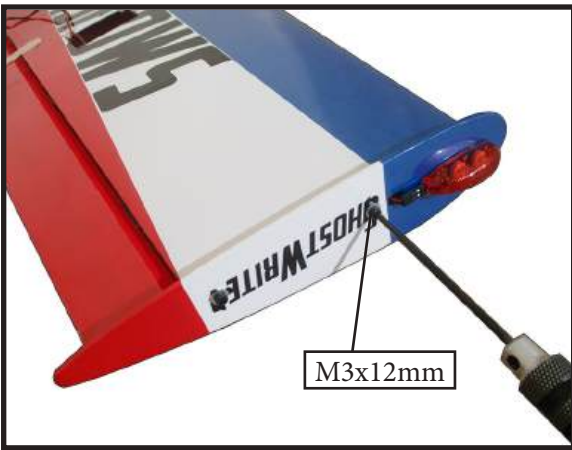

15.



## HINGING THE FLAP

1.

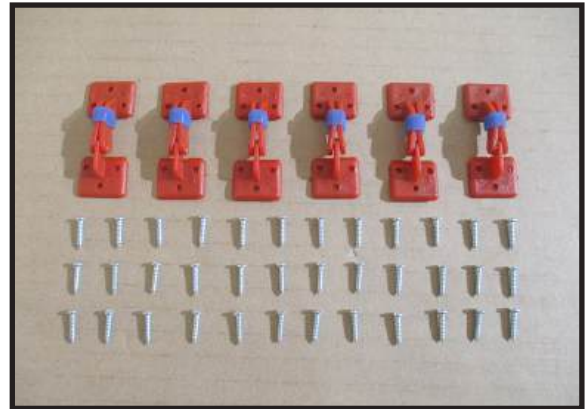

2.

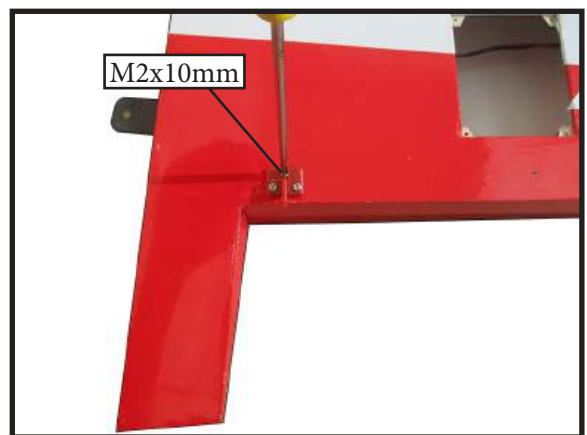

3.



4.



## HINGING THE AILERON

**Note:** *The control surfaces, including the ailerons, elevators, and rudder, are prehinged with hinges installed, but the hinges are not glued in place. It is imperative that you properly adhere the hinges in place per the steps that follow using a high-quality thin C/A glue.*

Carefully remove the aileron from one of the wing panels. Note the position of the hinges.

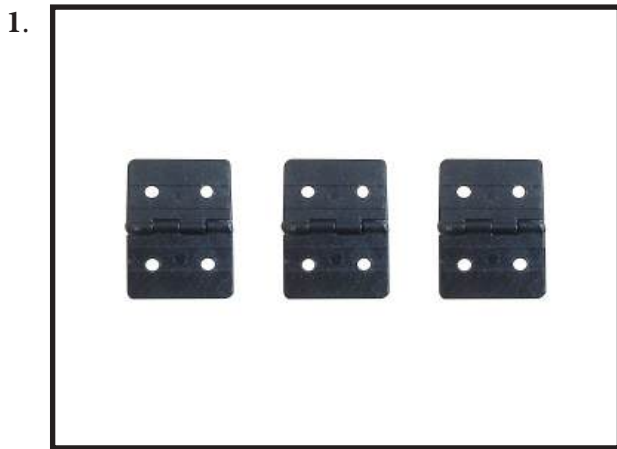

Prepare the aileron hinges by scuffing the area that will be inserted into the wing or flying surface with medium grit sand paper. Be careful not to remove too much material. Use isopropyl alcohol, and a paper towel to remove any excess debris that remains on the hinges.

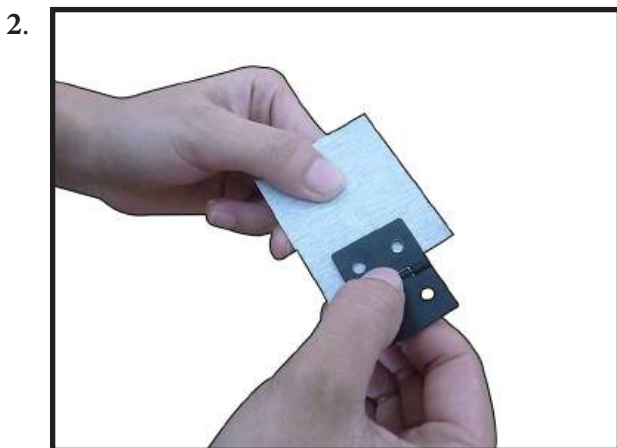

Mix a sufficient amount of 30-minute epoxy in a cup, and with a toothpick, smear epoxy in the hinge pockets of the wing panel and aileron. Slowly and carefully, insert each hinge into the wing panel. Partially remove and re-install the hinge to ensure that you've completely coated it with glue. Clean up any excess epoxy with isopropyl alcohol, and tape the aileron in place to cure.

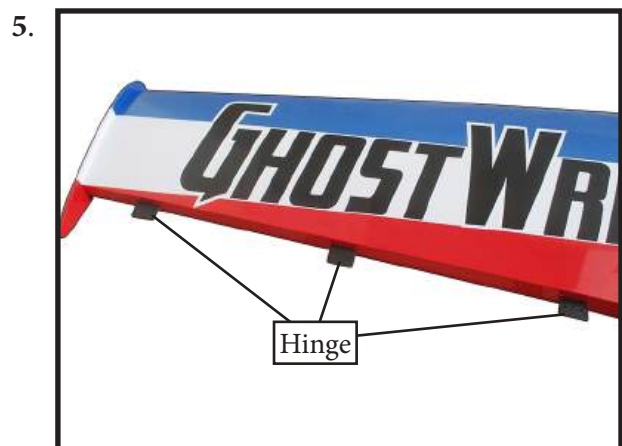
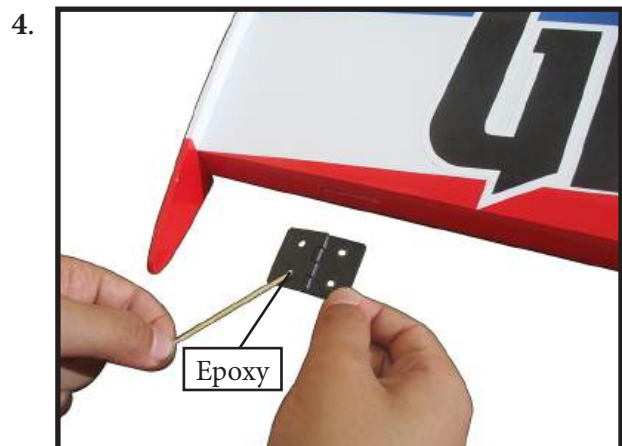
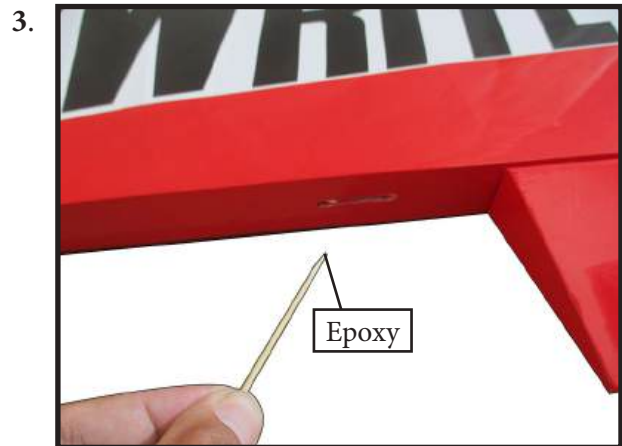



Press the aileron and wing together such that less than a 1/64" hinge line gap exists between the aileron and wing. The bevels should virtually touch. Use a paper towel and rubbing alcohol to wipe away any visible epoxy around the hinges.

Allow the glue to fully cure for at least 6 hours.

When fully cured, move each control surface throughout its travel range several times to break away any epoxy in the hinge. Be sure to deflect the surface fully.



**Note :** Work the aileron up and down several times to "work in" the hinges and check for proper movement.

### INSTALL THE AILERONS CONTROL HORN

Locate the aileron and flap control horns. The taller control horn is used for the ailerons, and the shorter horn for the flaps.

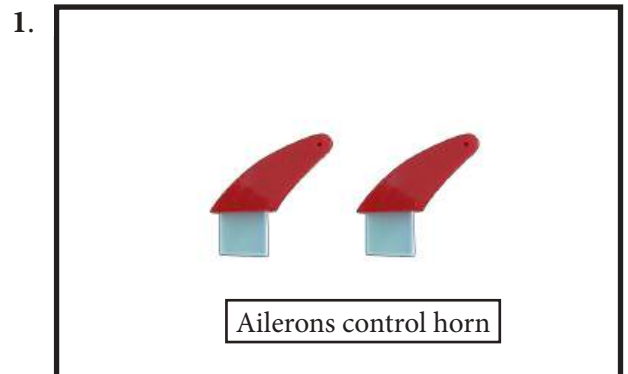

Use sandpaper to scuff the bottom of the aileron and flap control horns. Use a paper towel and isopropyl alcohol to remove any oils or debris from the control horns.

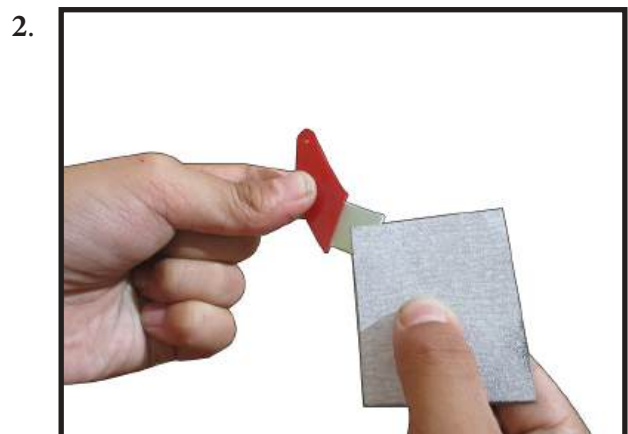

Check the fit of the control horns to the aileron and flap. They should rest flush against the control surface as shown.



Place low-tack tape 1/32 inch (1mm) from the control horn slot. This will prevent epoxy from getting on the control surface when the control horns are glued in place.

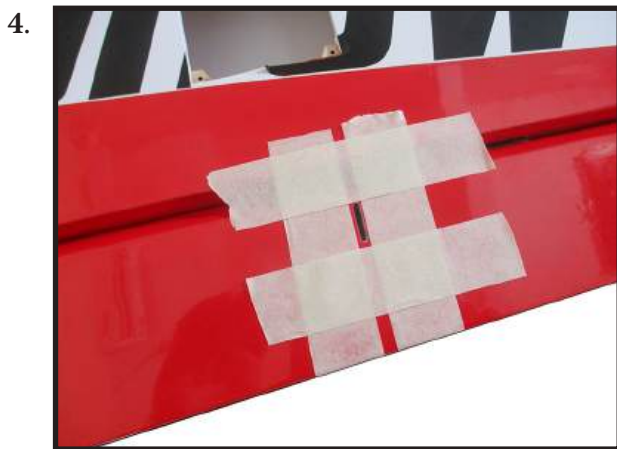

Remove the control horns from the control surfaces. Apply epoxy to the slot in the aileron and flap. Make sure the epoxy gets into the slot for a good bond between the surfaces and control horn.

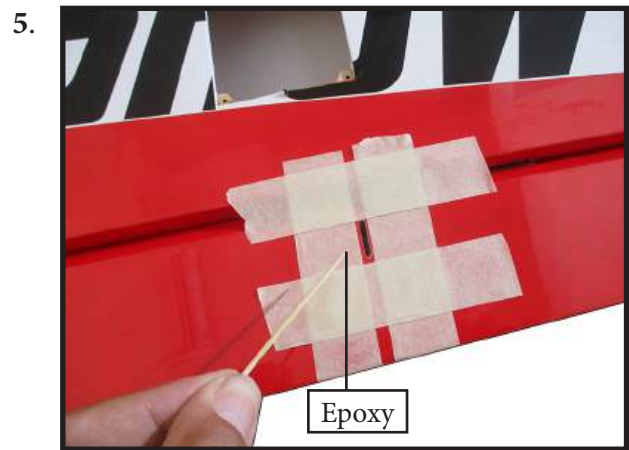

Apply epoxy to the area of the control horns that fist into the slots. Use enough epoxy so the control horns will be fully bonded to the fied surfaces.

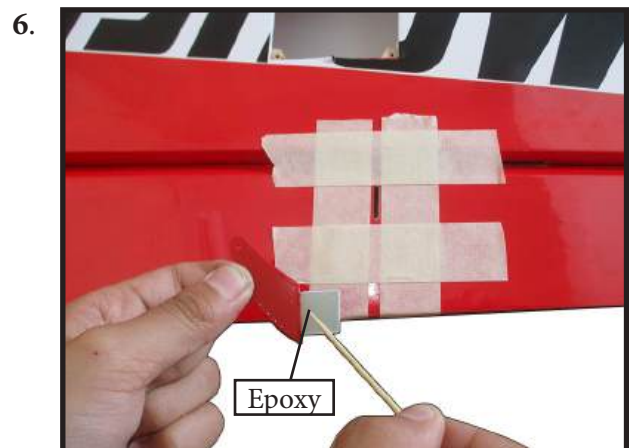

Before the epoxy fully cures, remove the tape from around the control horn. This will allow the epoxy to flow around the control horn, creating a small fillet between the control horn and surface for a finished look and secure bond.

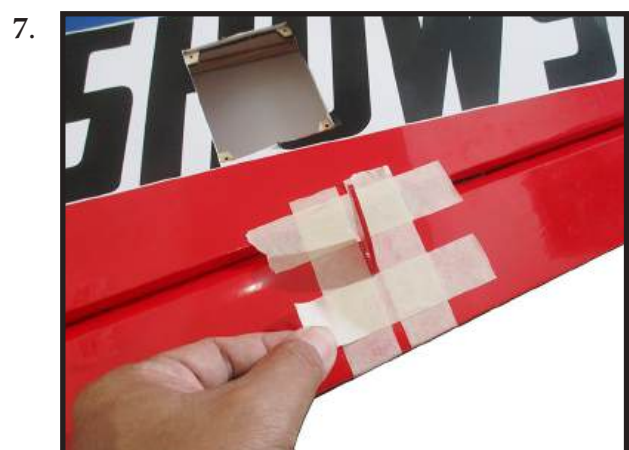

## INSTALL FLAP CONTROL HORN

Install the flap control horn using the same method as same as the aileron control horns.

1.

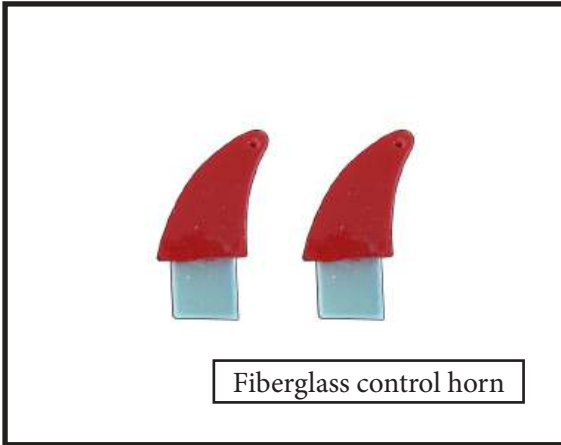

2.



3.

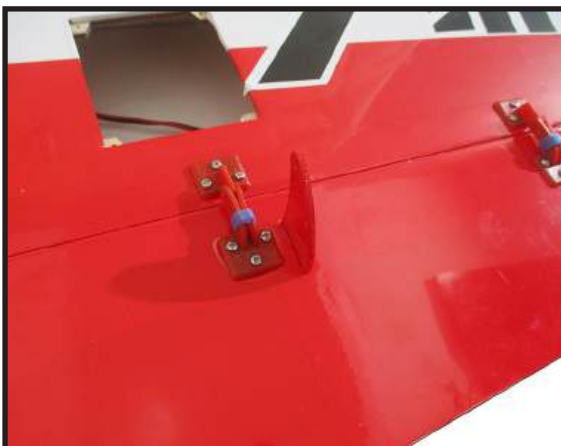

## INSTALLING THE AILERON SERVOS

1.

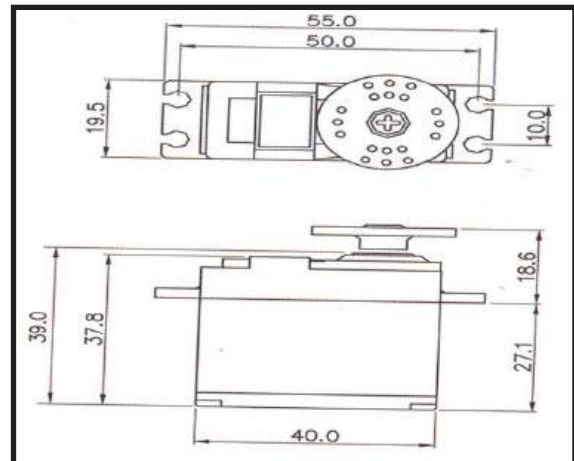

2.

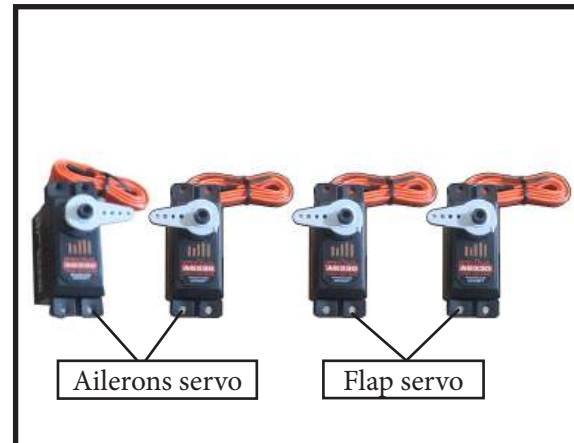

### Maximum Servo spec.

**Torque :** 126.6 oz-in (9.11 kg-cm) @ 6.0V;  
178 oz-in (12.82 kg-cm) @ 7.4V;  
248 oz-in (17.86 kg-cm) @ 8.4V

 Because the size of servos differ, you may need to adjust the size of the precut opening in the mount. The notch in the sides of the mount allow the servo lead to pass through.

Place the servo between the mounting blocks and space it from the hatch. Use a pencil to mark the mounting hole locations on the blocks.

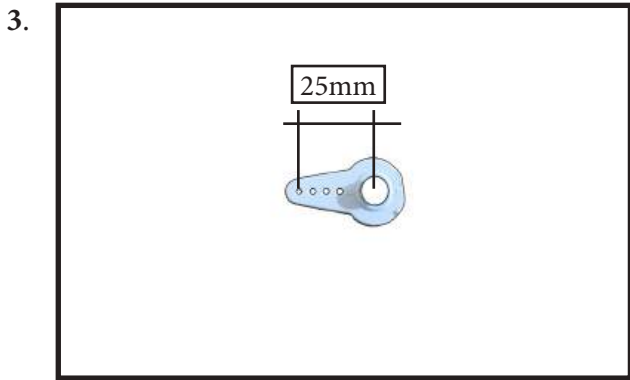

Use dental floss or heatshrink tube to secure the connection so they cannot become unplugged.

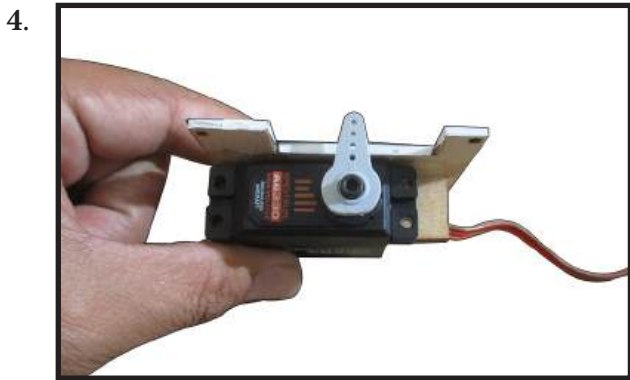
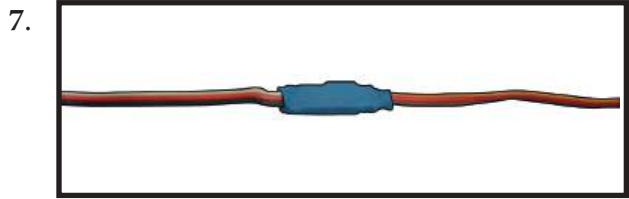

Secure the servo to the aileron hatch using Phillips screwdriver and the screws provided with the servo.



Use drill bit in a pin vise to drill the mounting holes in the blocks.

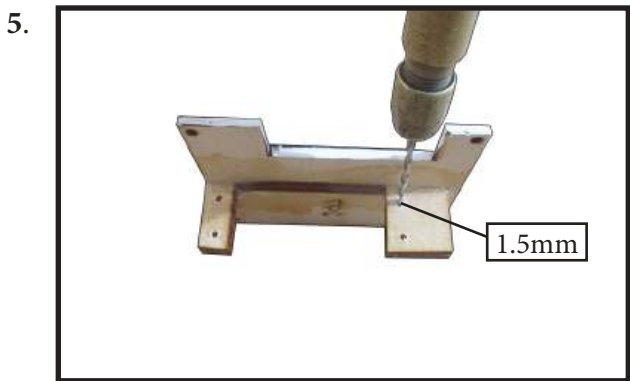

Apply 1-2 drops of thin C/A to each of the mounting tabs. Allow the C/A to cure without using accelerator.

Apply 2-3 drops of thin C/A to each of the mounting holes. Allow the C/A to cure without using accelerator.

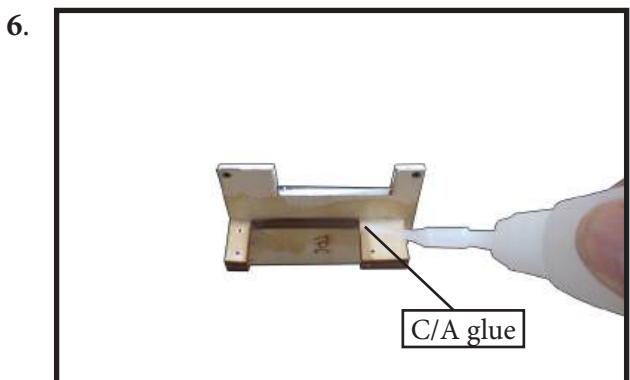
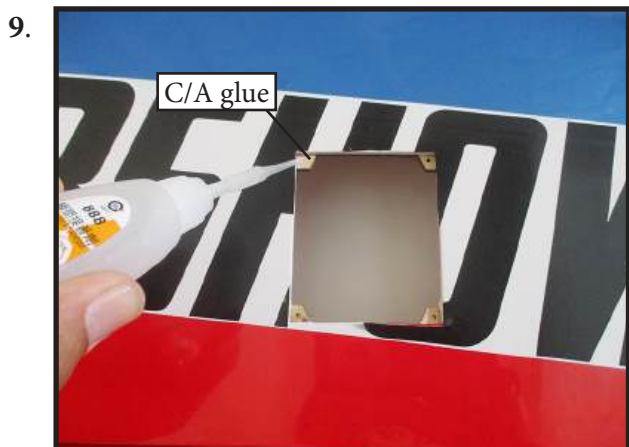

Remove the string from the wing at the servo location and use the tape to attach it to the servo extension lead. Pull the lead through the wing and remove the string.

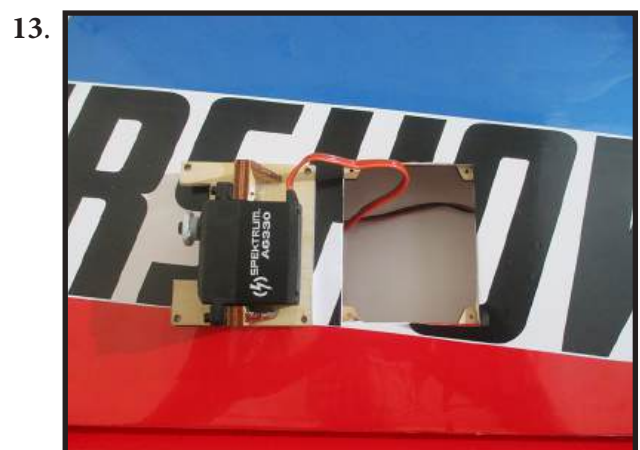
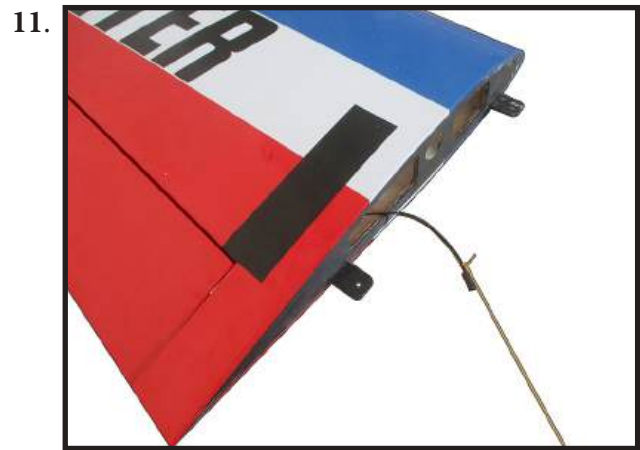

Set the aileron hatch in place and use a Phillips screw driver to install it with four wood screws.



### AILERON PUSHROD INSTALLATION

Please see below pictures.

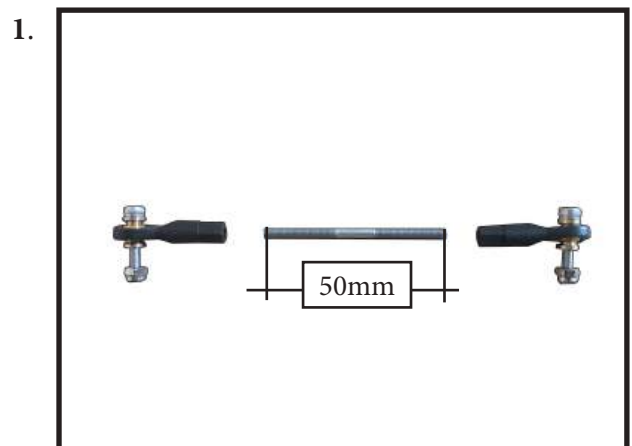

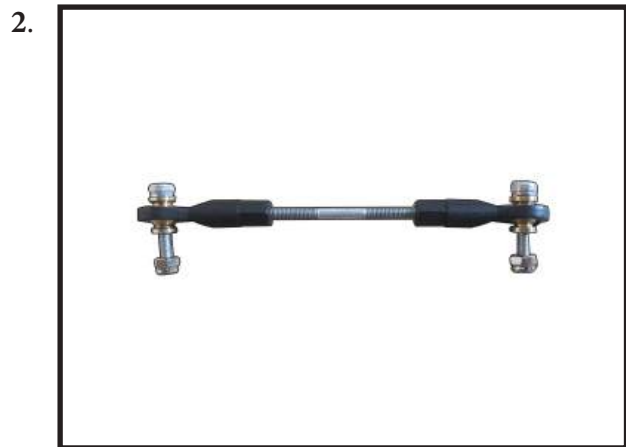
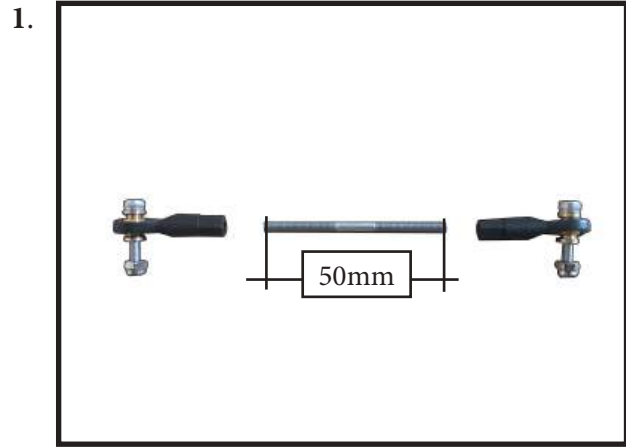
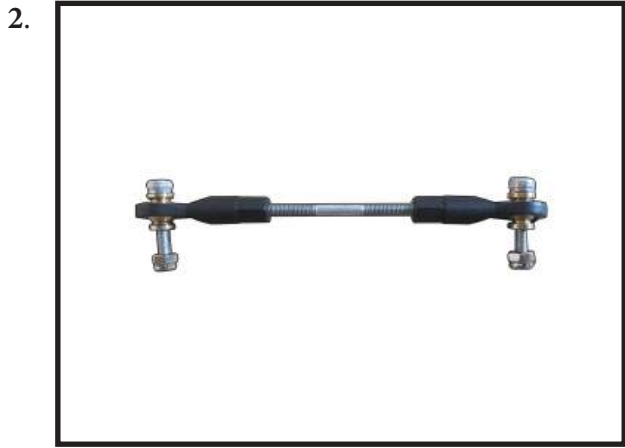

**INSTALLING THE FLAP SERVO**

Repeat the procedure for the flap servo.

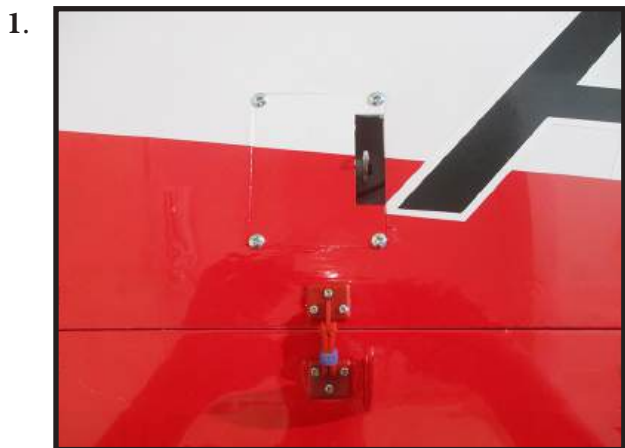

**INSTALLING THE FLAP PUSHROD**

Repeat the procedure for the aileron pushrod.

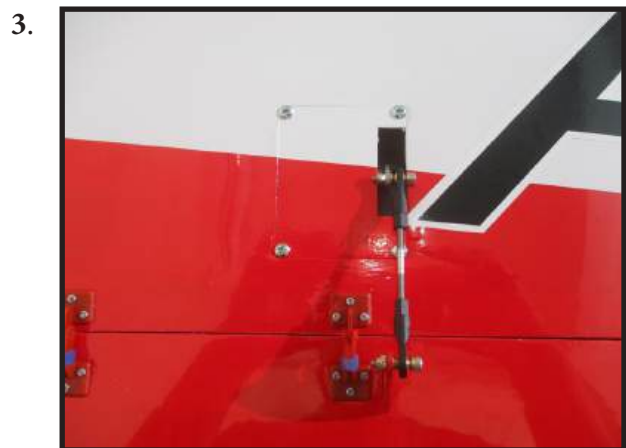

**INSTALLING LANDING GEAR**

Locate items necessary to install Spring Landing Gear.

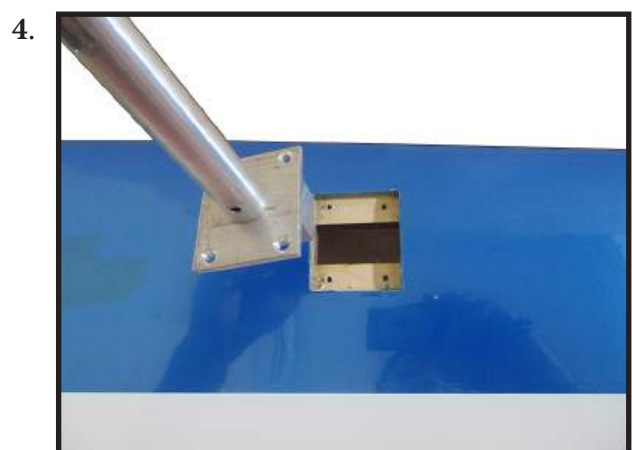
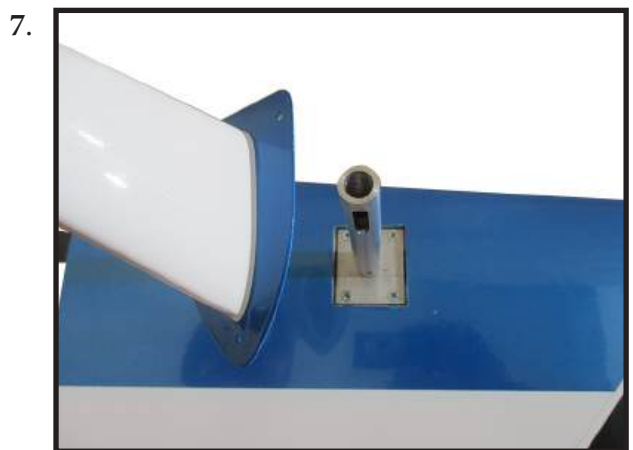
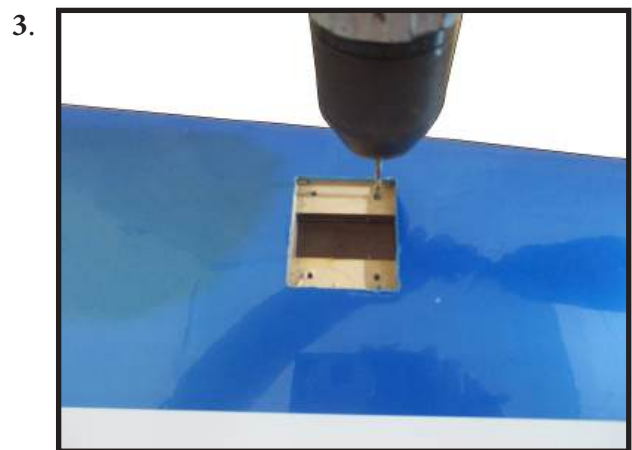
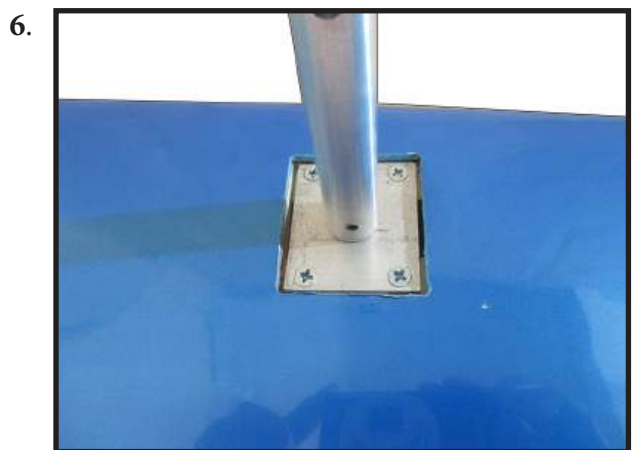
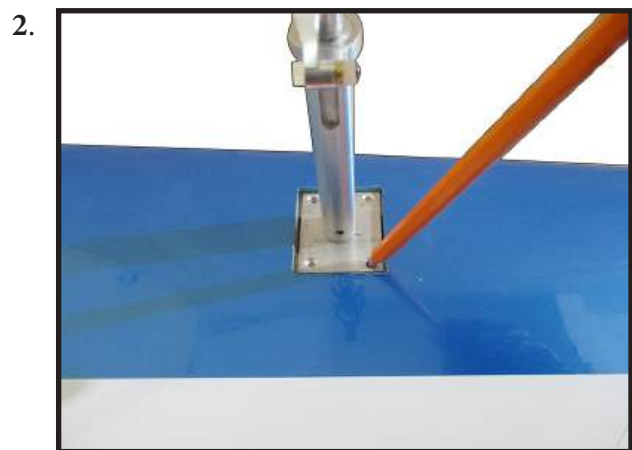
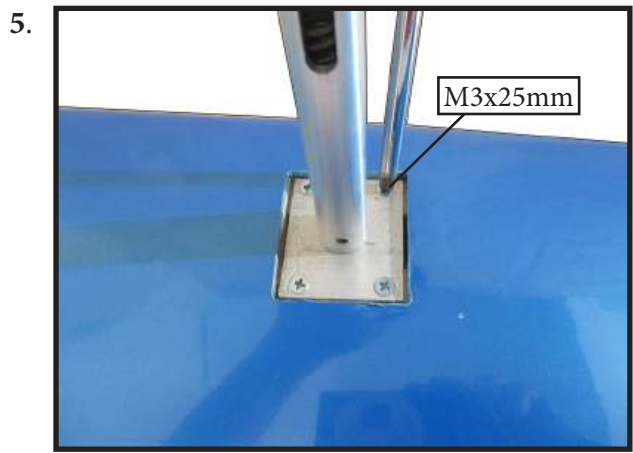

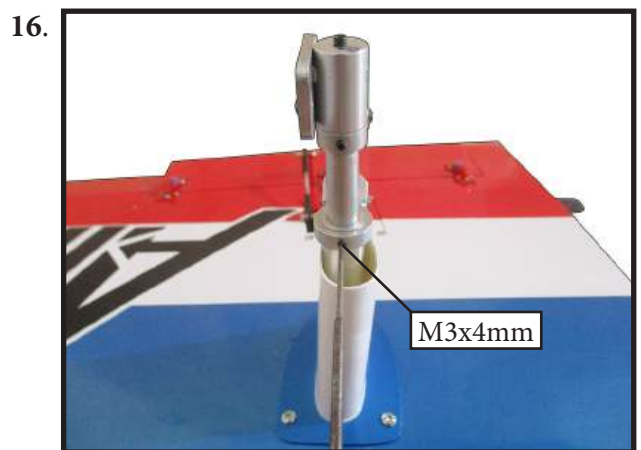
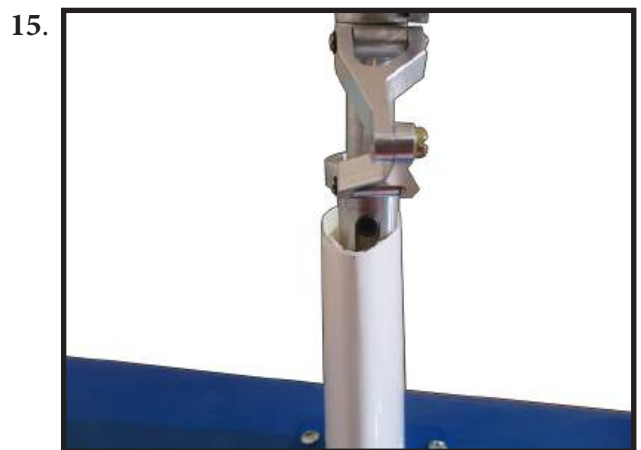
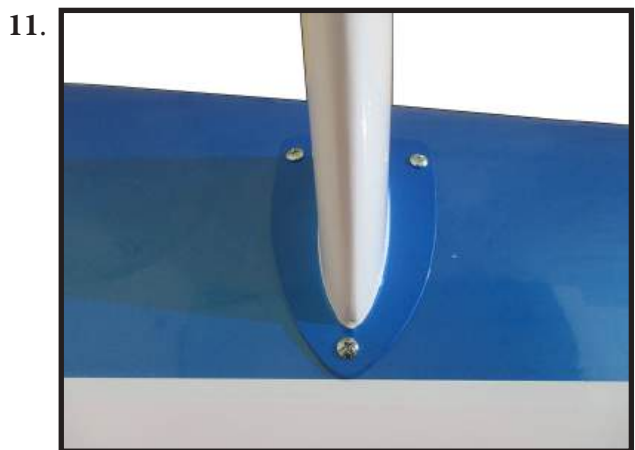
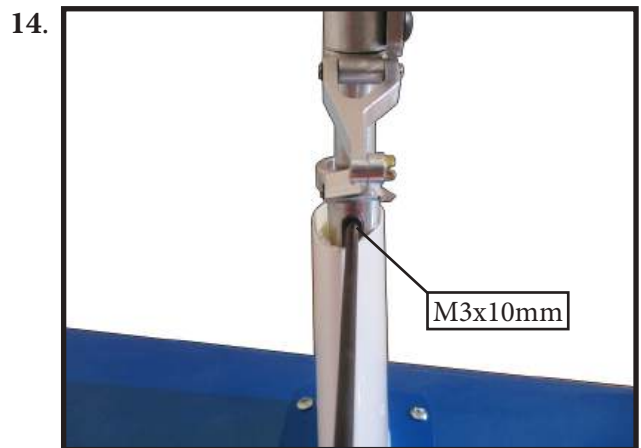
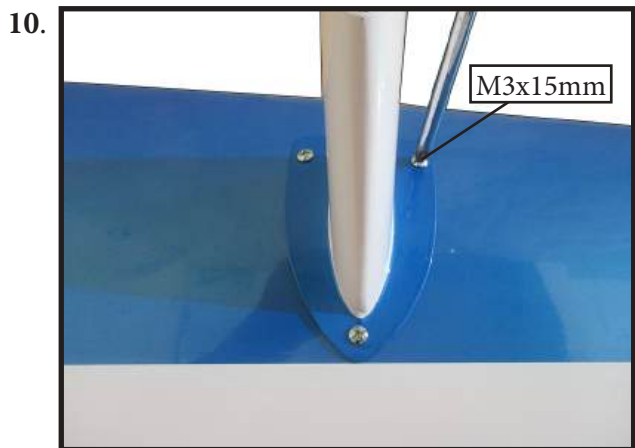
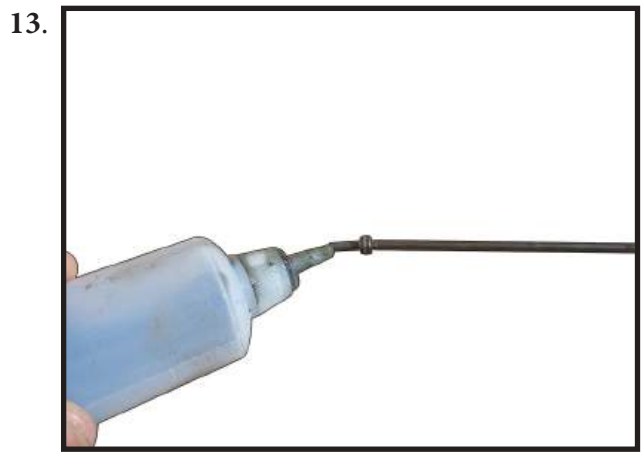
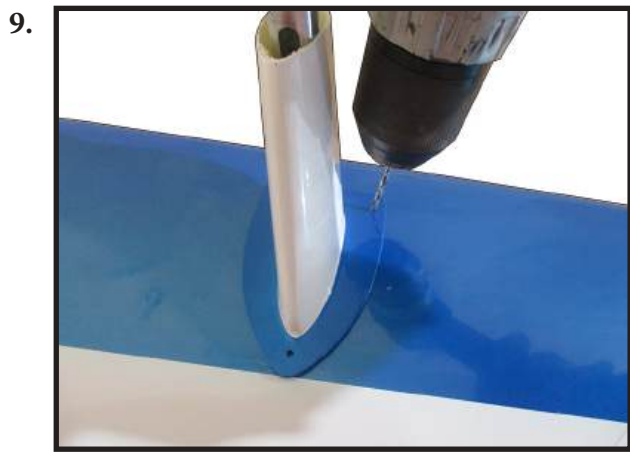

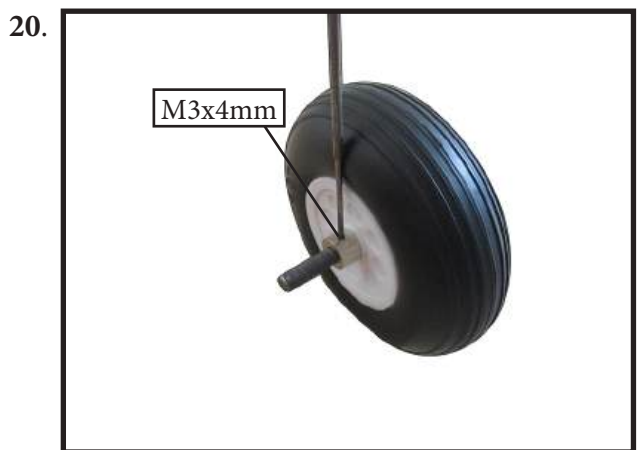
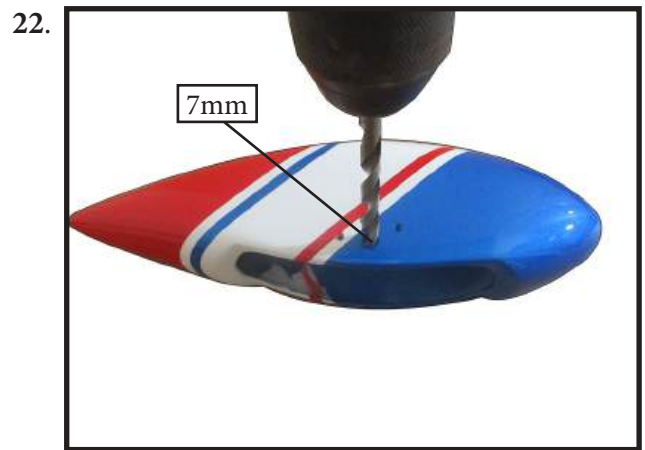
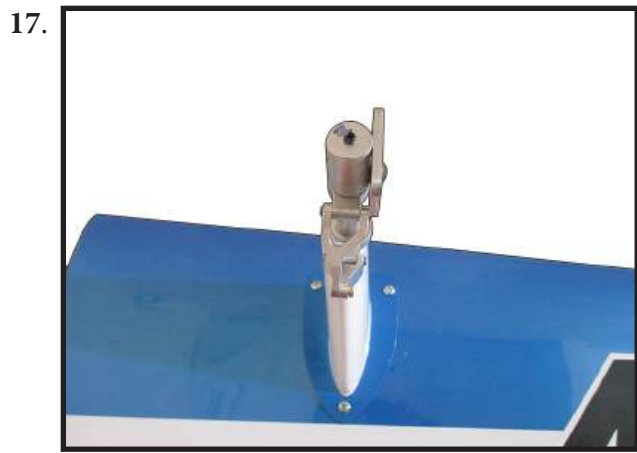

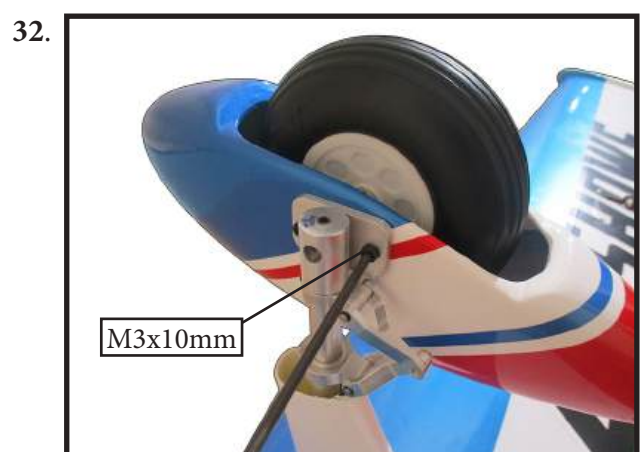
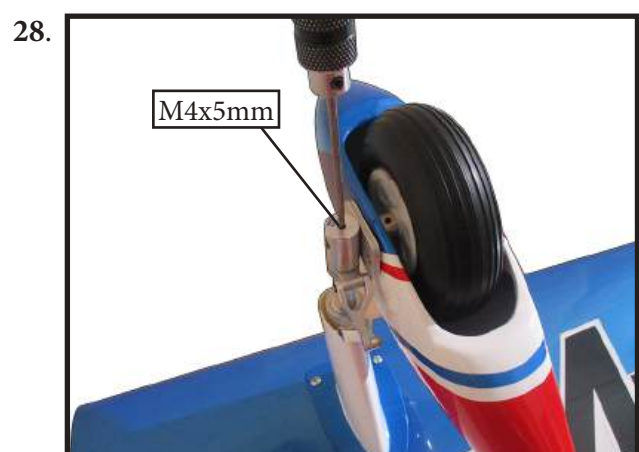
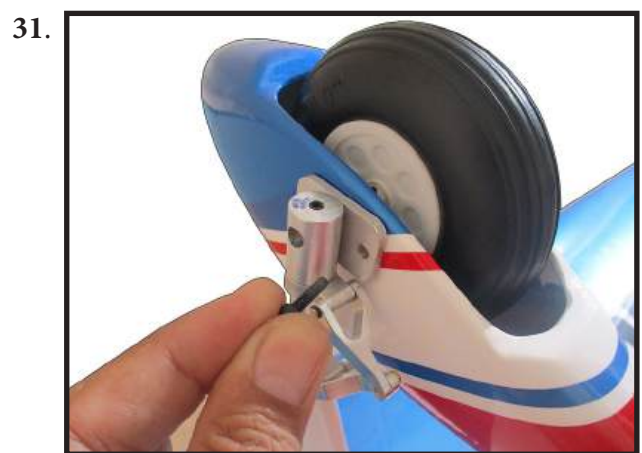
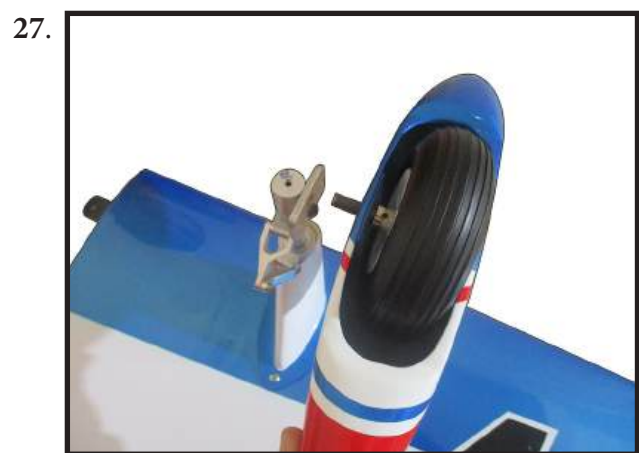
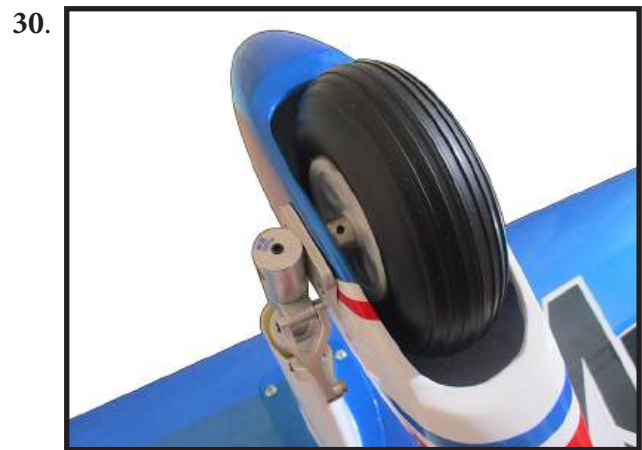
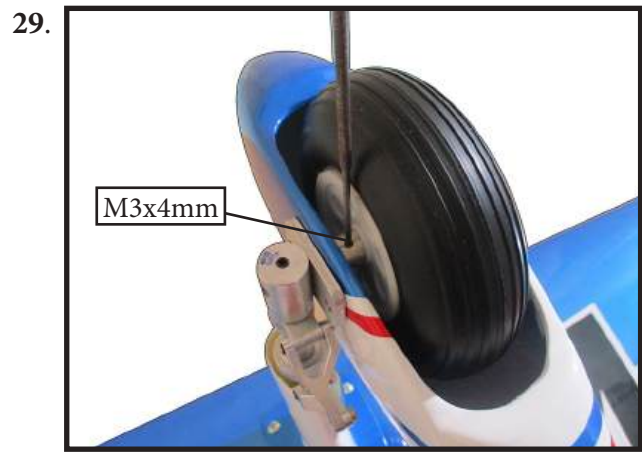



### INSTALLING THE FUSELAGE SERVOS

⚠ Because the size of servos differ, you may need to adjust the size of the precut opening in the mount. The notch in the sides of the mount allow the servo lead to pass through.

Secure the servos with the screws provided with your servo.

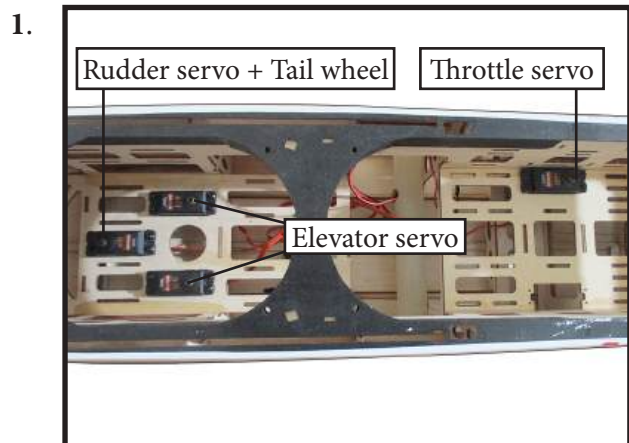

**THROTTLE SERVO ARM INSTALLATION**

Install adjustable servo connector on the servo arm and set aside for now.

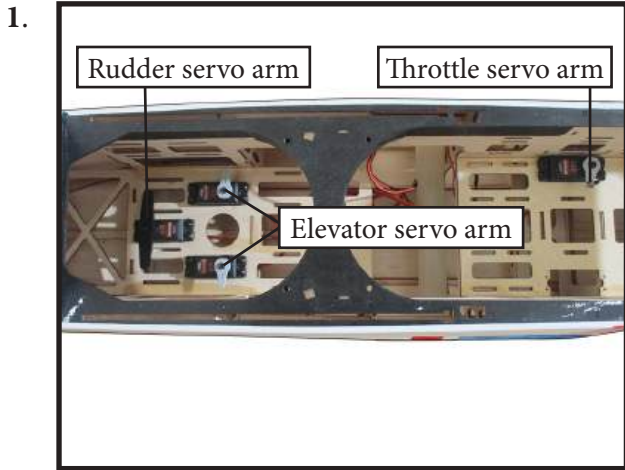

Install the rudder and elevator servo arms as shown above.

**INSTALLING THE RECEIVER SWITCH**

Install the switch into the precut hole in the side of fuselage, or you may hide switches under main hatch on a custom home made switch plate as desired.

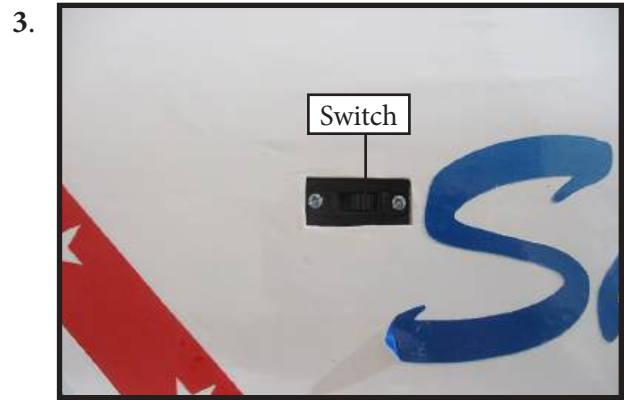
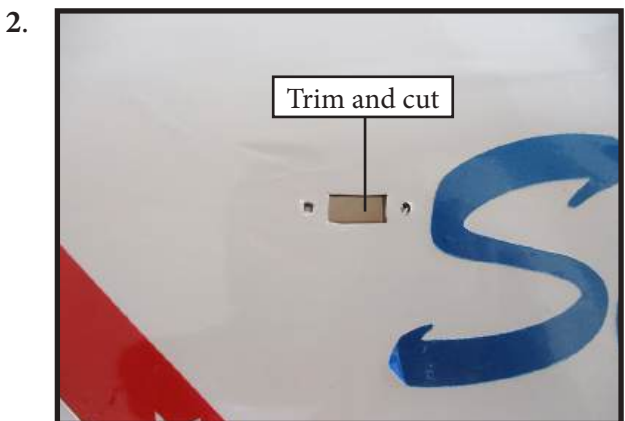
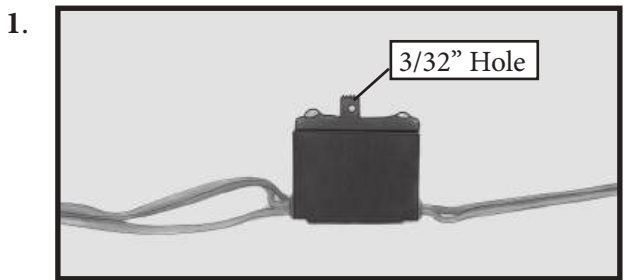

**INSTALLING THE ENGINE SWITCH**

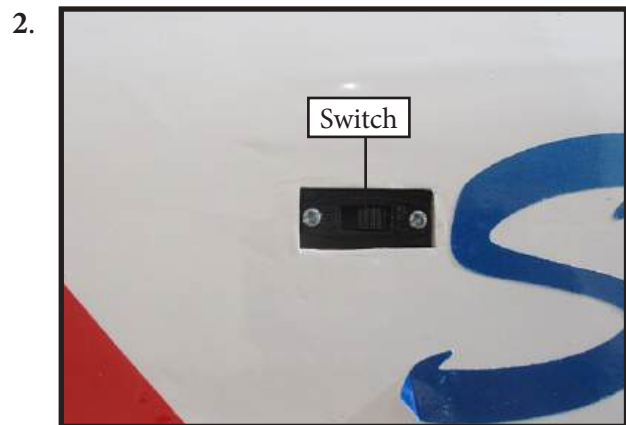
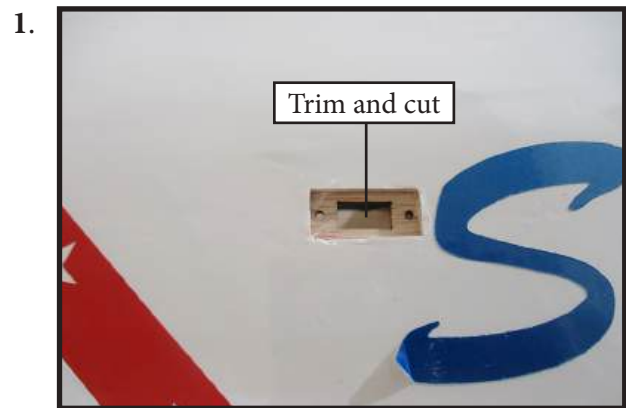

**INSTALLING THE STOPPER ASSEMBLY**

Using a modeling knife, carefully cut off the rear portion of one of the 3 nylon tubes leaving 1/2" protruding from the rear of the stopper. This will be the fuel pick up tube.

Using a modeling knife, cut one length of silicon fuel line. Connect one end of the line to the weighted fuel pick up and the other end to the nylon pick up tube.

1.

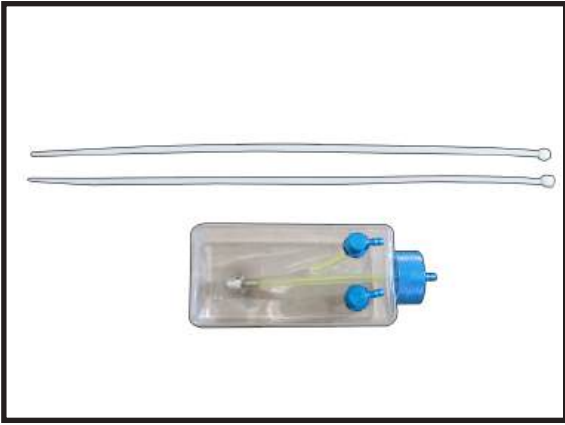

Carefully bend the second nylon tube up at a 45° angle. This tube is the vent tube.

Test fit the stopper assembly into the tank. It may be necessary to remove some of the flashing around the tank opening using a modeling knife. If flashing is present, make sure none falls into the tank.

With the stopper assembly in place, the weighted pick-up should rest away from the rear of the tank and move freely inside the tank. The top of the vent tube should rest just below the top of the tank. It should not touch the top of the tank.

When satisfied with the alignment of the stopper assembly tighten the 3 x 20mm machine screw until the rubber stopper expands and seals the tank opening. Do not over-tighten the assembly as this could cause the tank to split.

## FUEL TANK INSTALLATION

1.

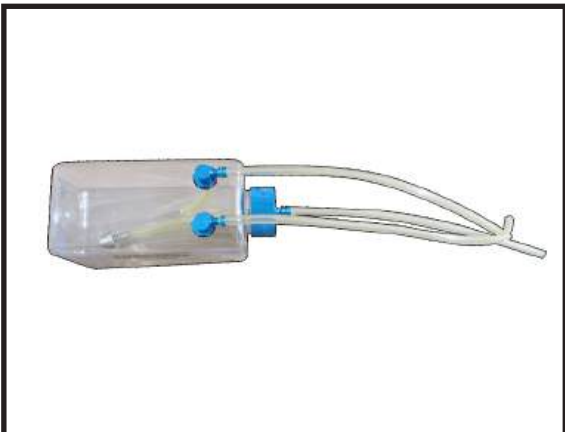

 You should mark which tube is the vent and which is the fuel pickup when you attach fuel tubing to the tubes in the stopper. Once the tank is installed inside the fuselage, it may be difficult to determine which is which.

2.



3.



4.

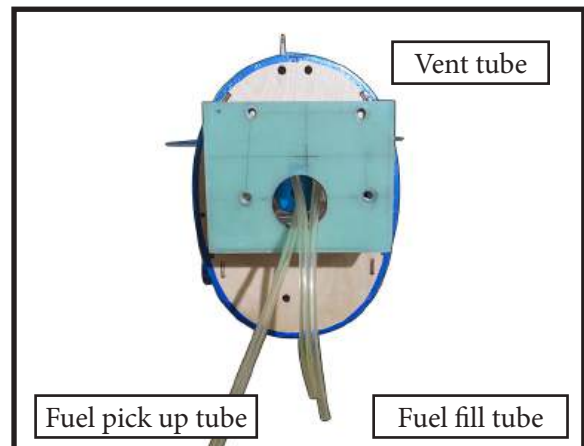

Later you will connect the lines from the tank to the engine and muffler. The vent line will connect to the muffler and the line from the tank to the carburetor.

### MOUNTING THE ENGINE

Please see below pictures.

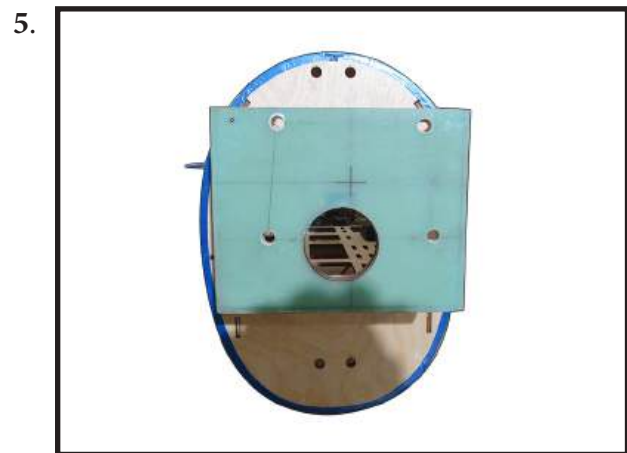
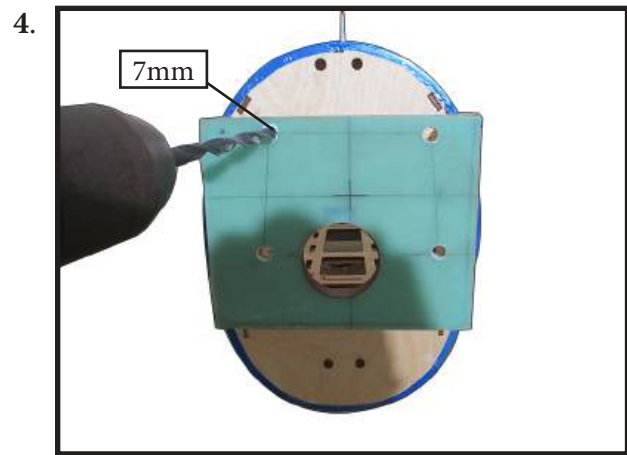
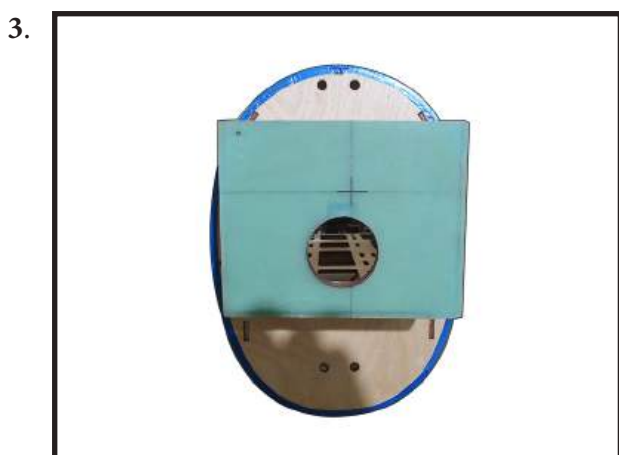
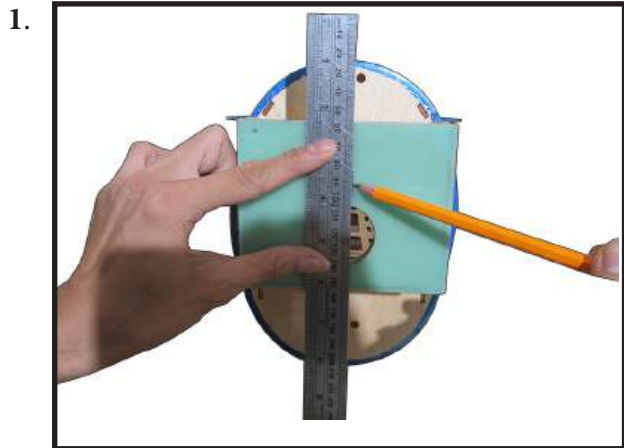

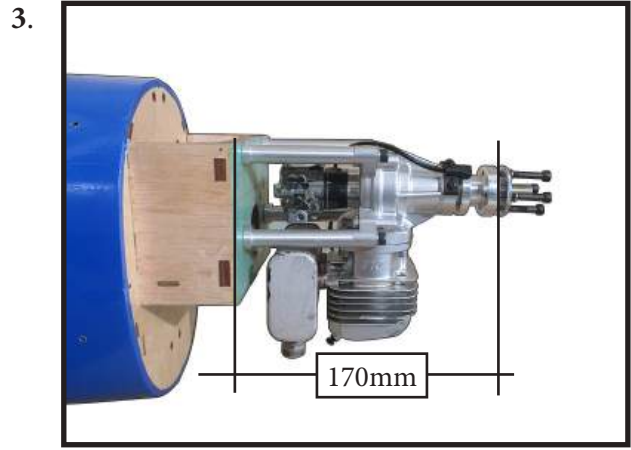
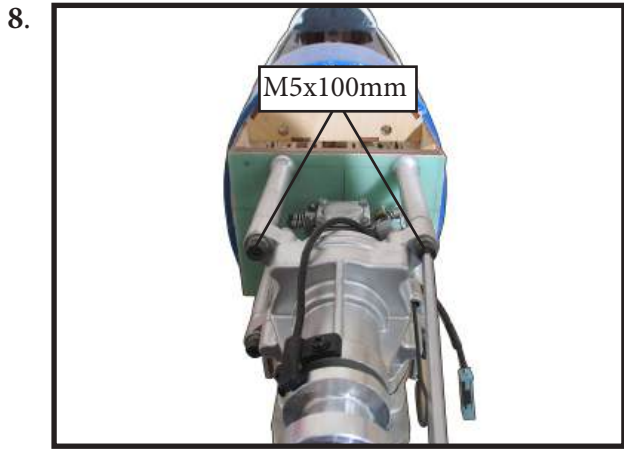

**THROTTLE SERVO INSTALLATION**

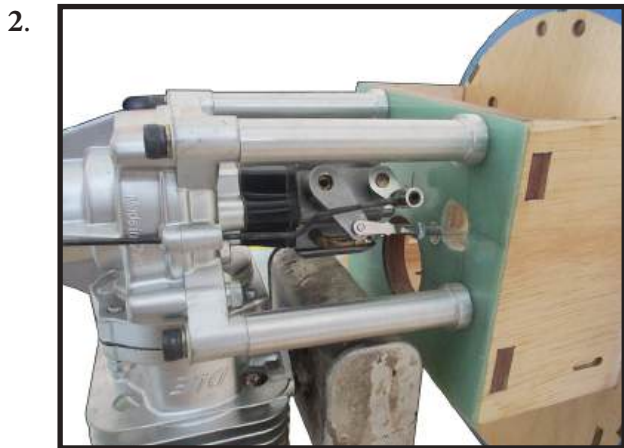
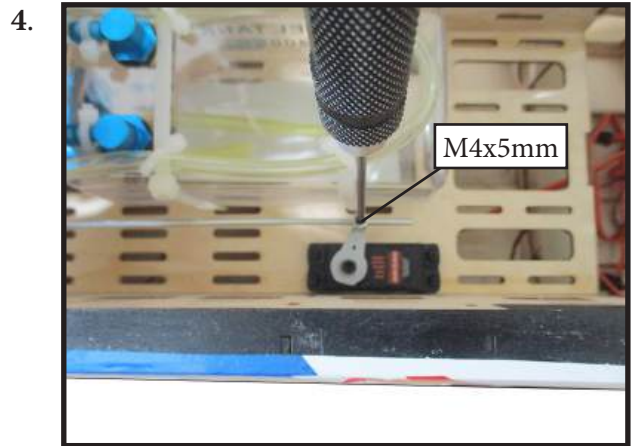
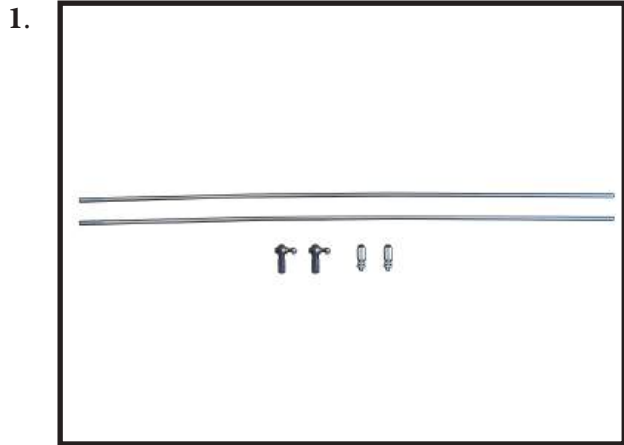

Move the throttle stick to the closed position and move the carburetor to closed. Use a 2.5mm hex wrench to tighten the screw that secures the throttle pushrod wire. Make sure to use threadlock on the screw so it does not vibrate loose.

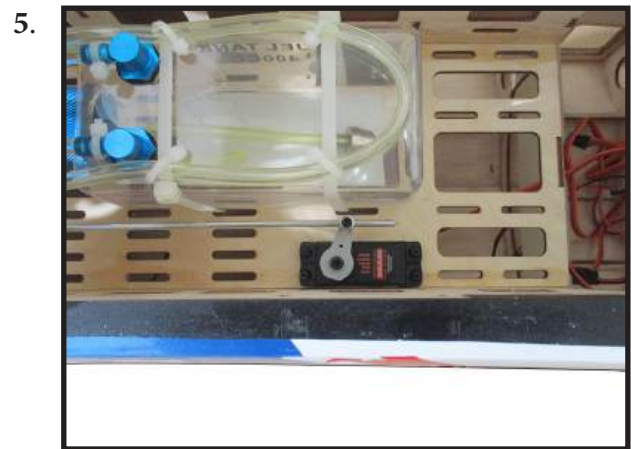

Attach throttle pushrod to the carburetor throttle arm with the ball link.

**IGNITION INSTALLATION**

1 Thread nylon tie through mounting holes.

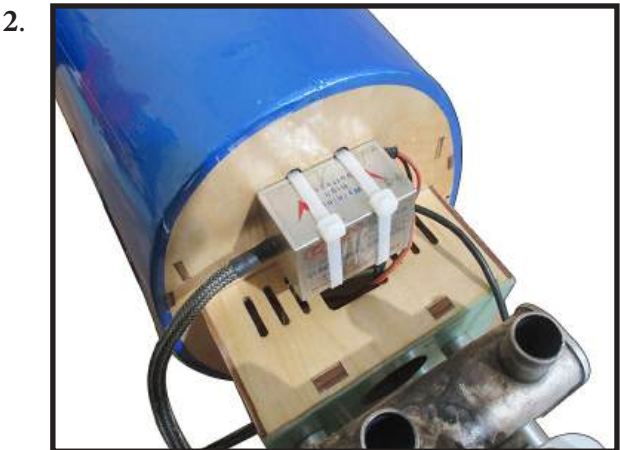
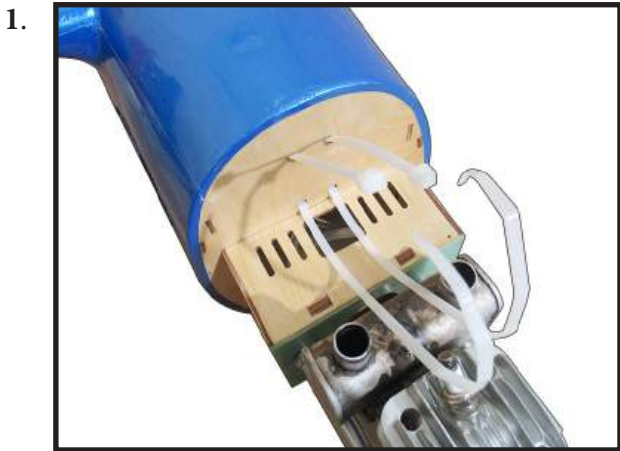

Connect ignition module to pickup line of engine. Secure with Safety Clip, safety wire, tape or other method. Ensure the plugs will not come apart from vibration or light tension.

Secure ignition wire with nylon ties as necessary.

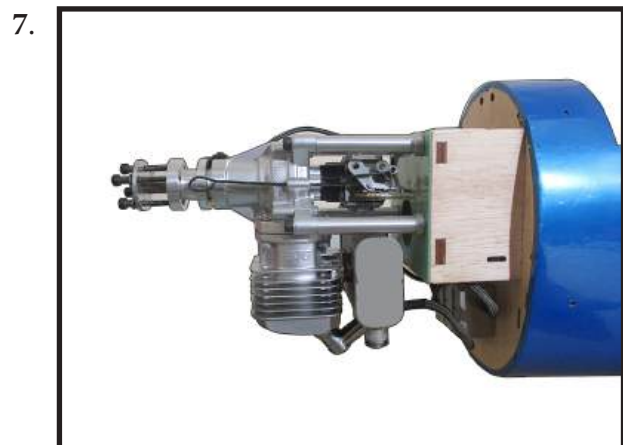
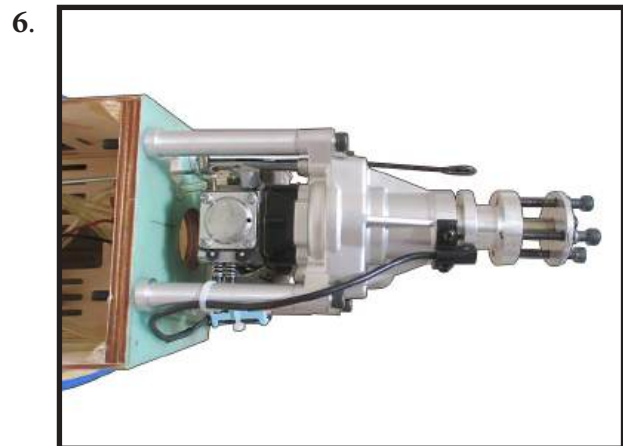
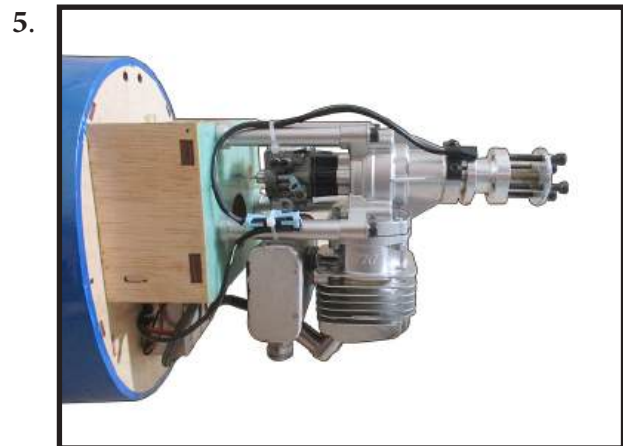
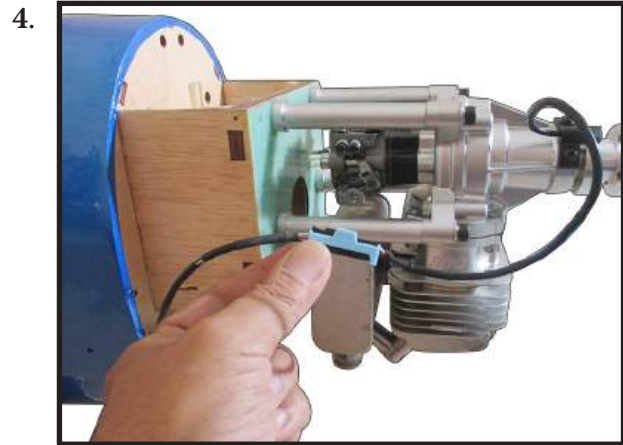
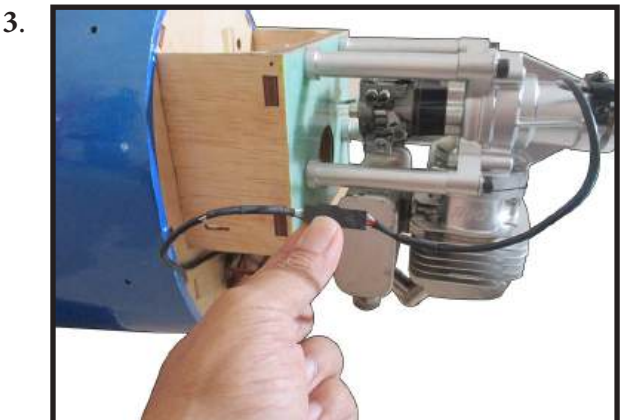

8.

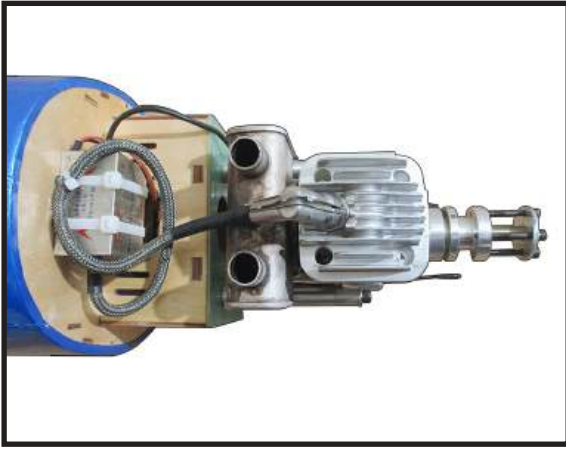

**COWLING**

Please study images below.

1.



2.



3.



Tape the cowl to the fuselage using low-tack tape.

4.

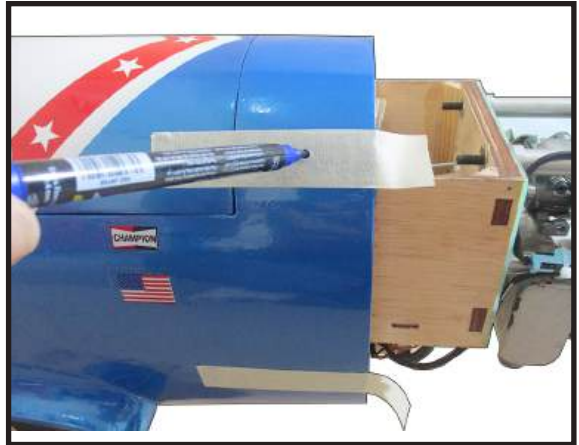

5.



Use a drill and drill bit to drill the holes for the cowl mounting screws. Make sure the cowl position is correct before drilling each hole.

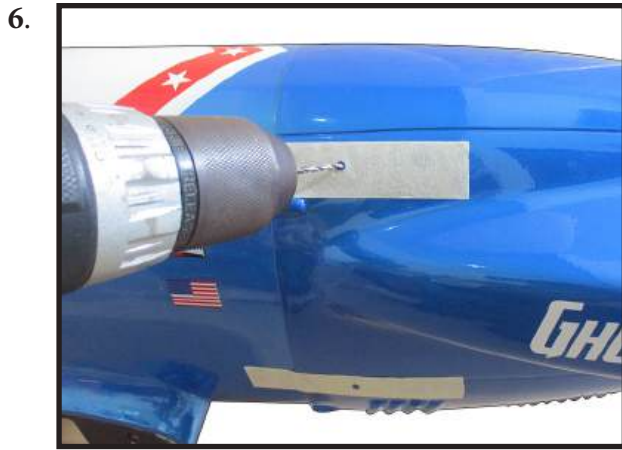

Install the muffler onto the engine and make the cutout in the cowl for muffler clearance. Connect the fuel and pressure lines to the carburetor, muffler and fuel filler valve. Secure the cowl to fuselage using the M3x10mm socket head screws. Putting a small length of silicone fuel tube under the head of the screw helps with vibration.

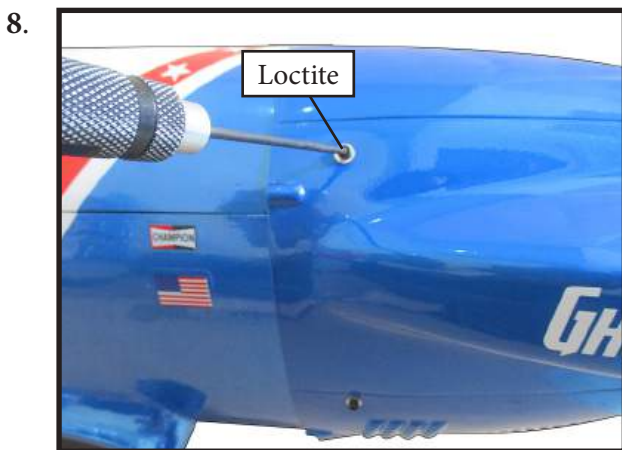
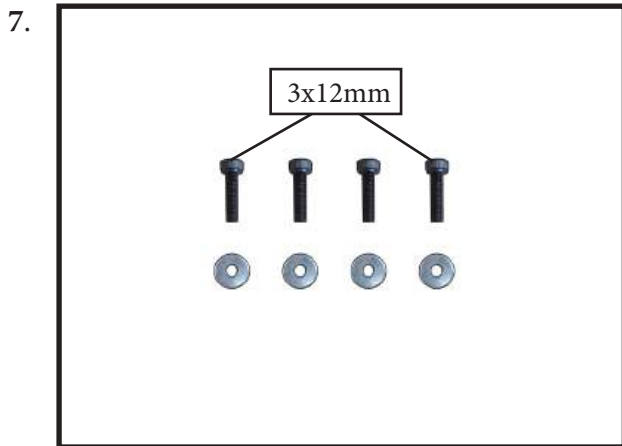

## ELECTRIC POWER CONVERSION

Locate the items necessary to install the electric power conversion included with your model.

1.

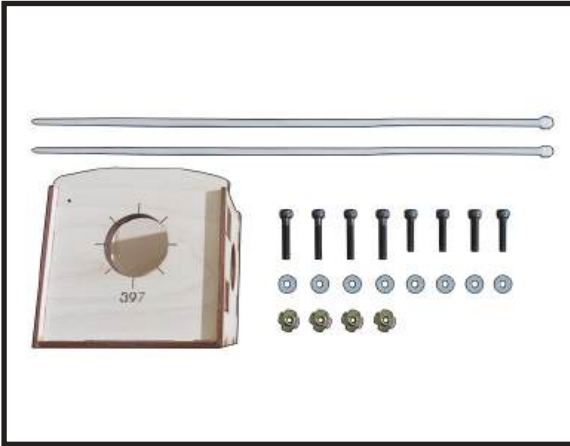

Recommend the items necessary to install the electric power conversion parts included with your model.

- **Motor: 180 - 195kv**
- **Propeller: 20x12**
- **ESC: 80A - 120A**
- **Lipo: 10 - 12S 3300 - 4200mAh**

Attach the electric motor box to the firewall centered with the cross lines drawn on the electric motor box and firewall. Using M5x30mm to secure the motor box to the firewall. Please see pictures below.

2.



3.

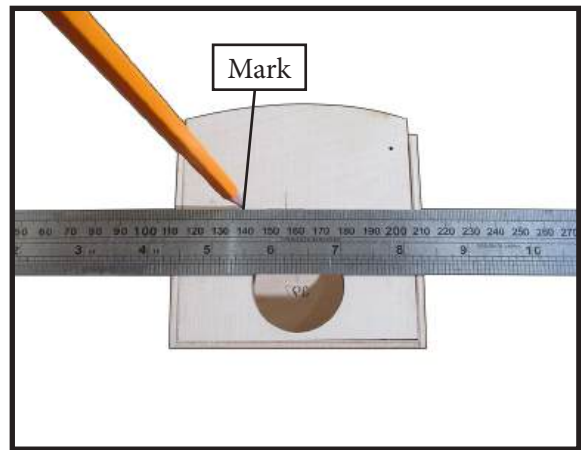

4.



5.

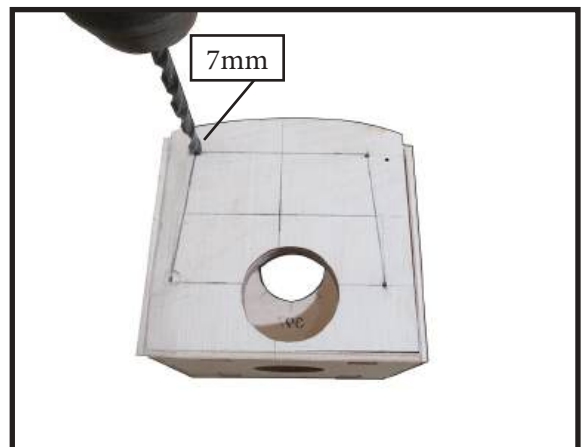

6.



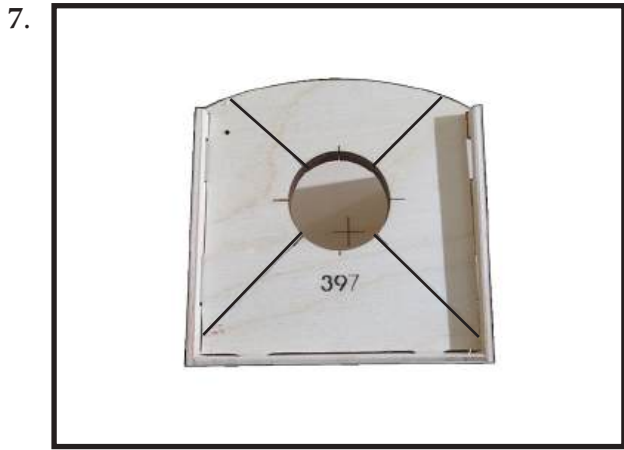

Attach the motor mount to the front of the electric motor box using four 5mm blind nut, four M5x30mm hex head bolts to secure the motor. Please see picture shown.

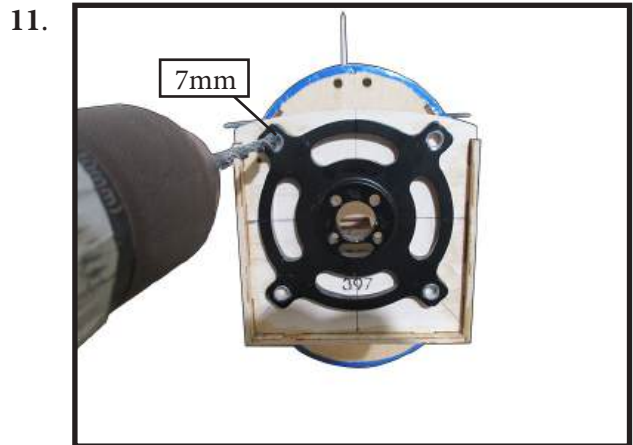
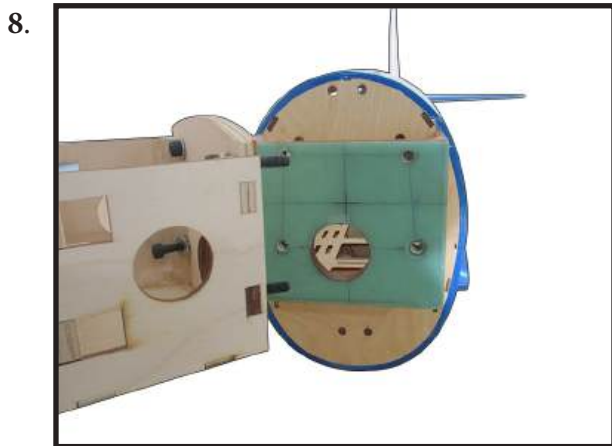

Then, use 7mm drill bit to enlarge the holes on the electric motor box.

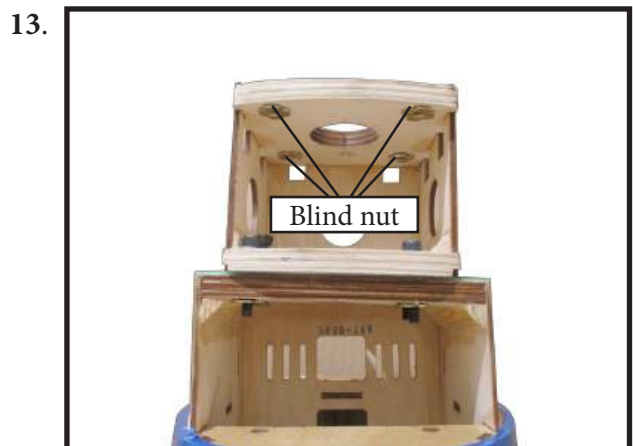
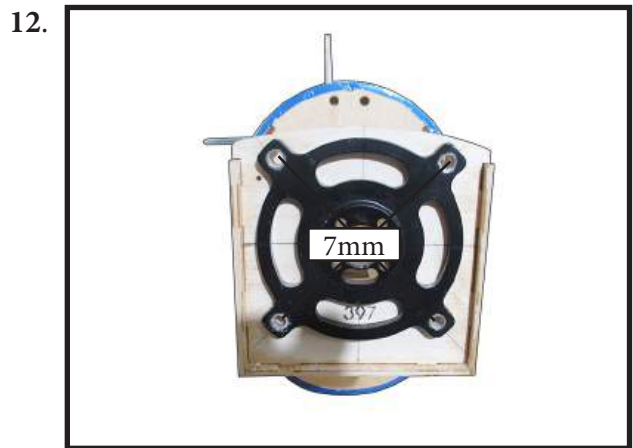

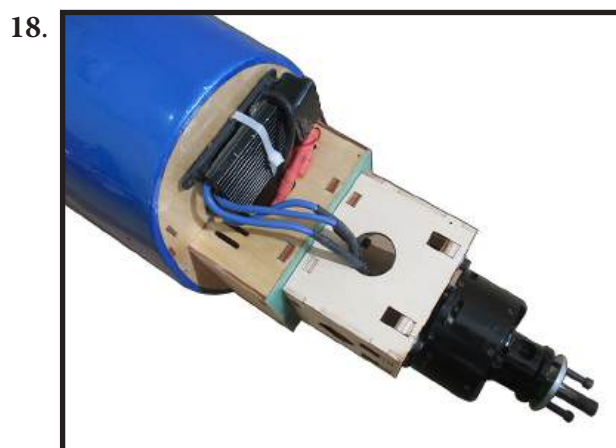
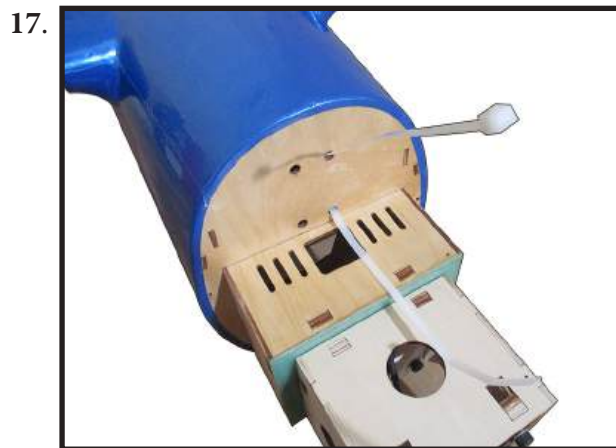
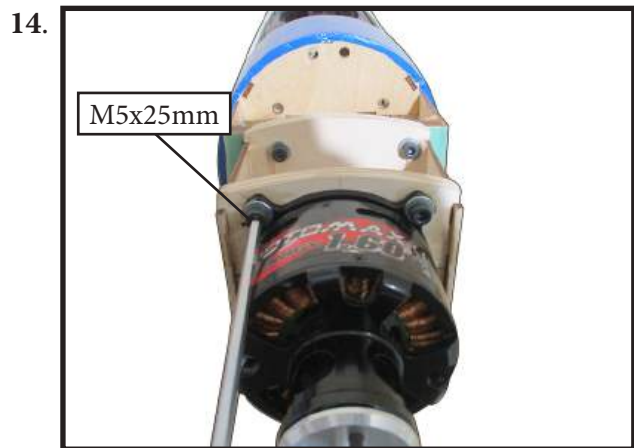

Attach the speed control to the side of the motor box using two-sided tape and tie wraps. Connect the appropriate leads from the speed control to the motor. Make sure the leads will not interfere with the operation of the motor.

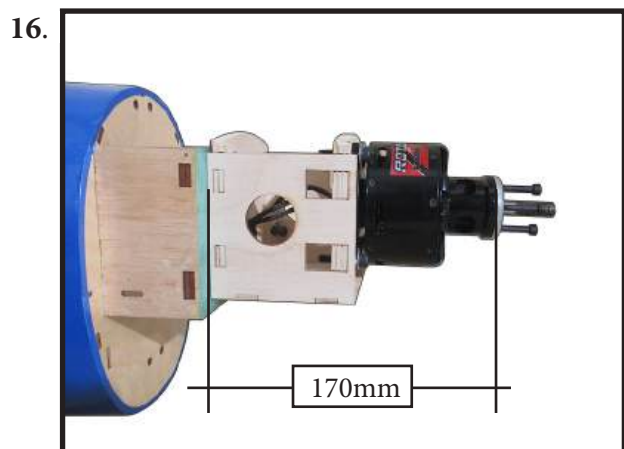

**INSTALLING THE PROP/HUB**

Install the spinner backplate, propeller and proper hub of your choice.



 The propeller should not touch any part of the cowling. If it does, check and adjust engine mounting/cowl spacing as needed to where the propeller will not come in contact with the cowling.



**INSTALL NAIL HINGE ELEVATOR**

Test fit the hinges into the elevator, and then the hinges into the tail. Ensure that the hinge pockets line up, and that the hinges move freely.

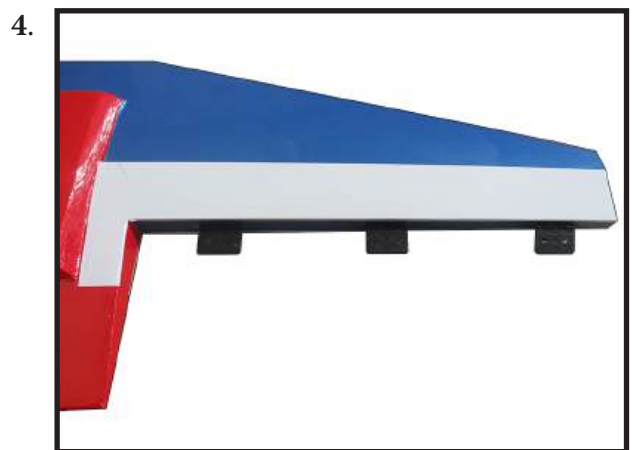
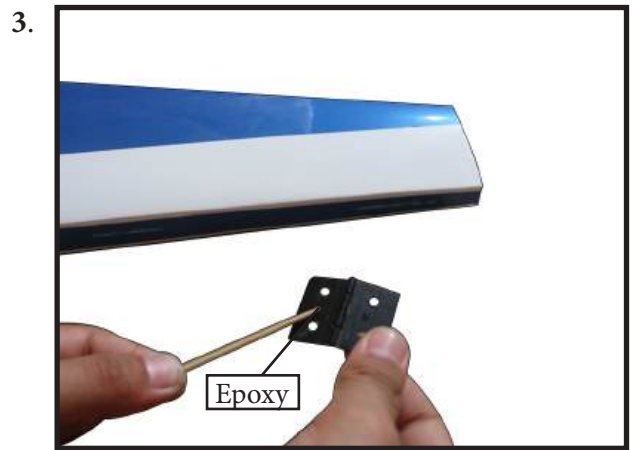
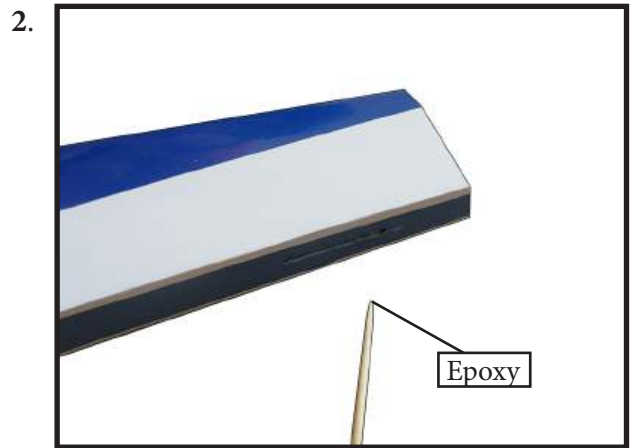

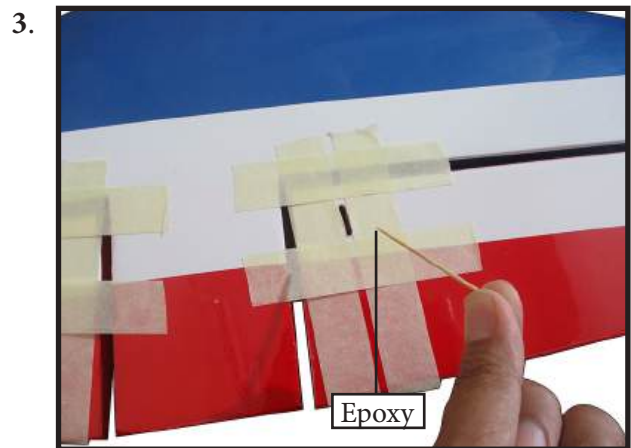
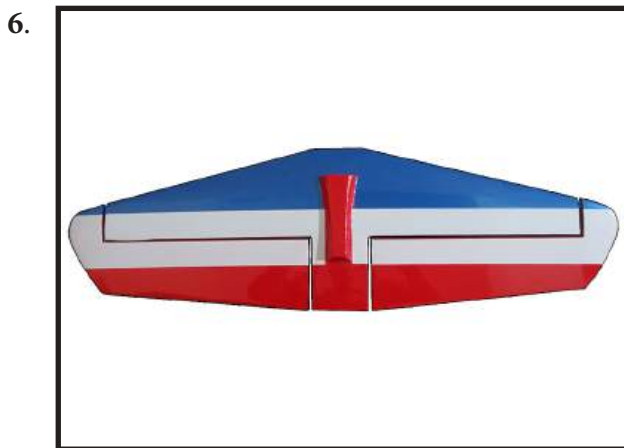
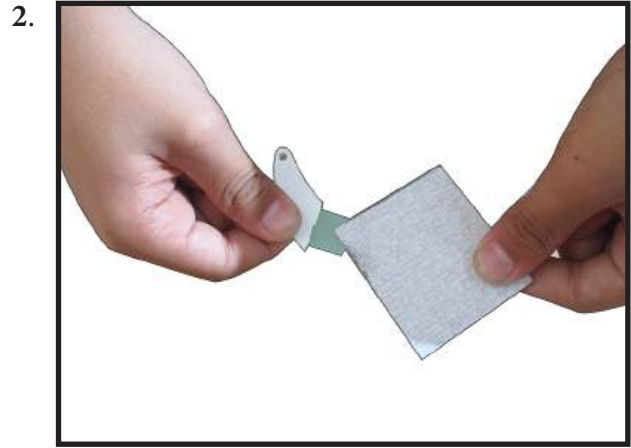
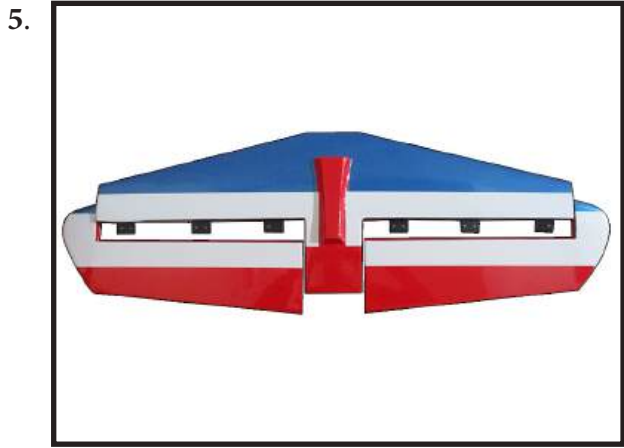

**INSTALL ELEVATOR CONTROL HORN**

Install the elevator control horn using the same method as same as the elevator control horns.

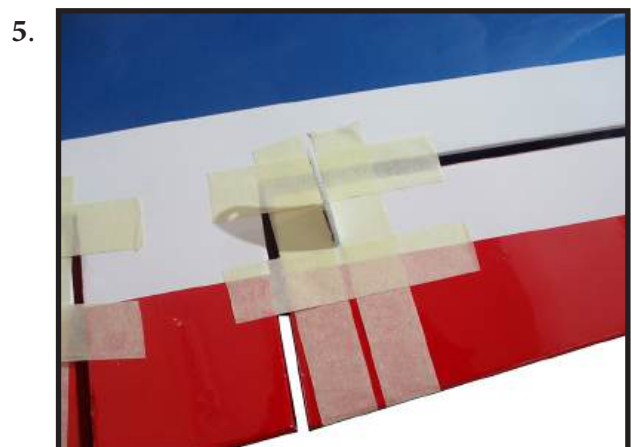
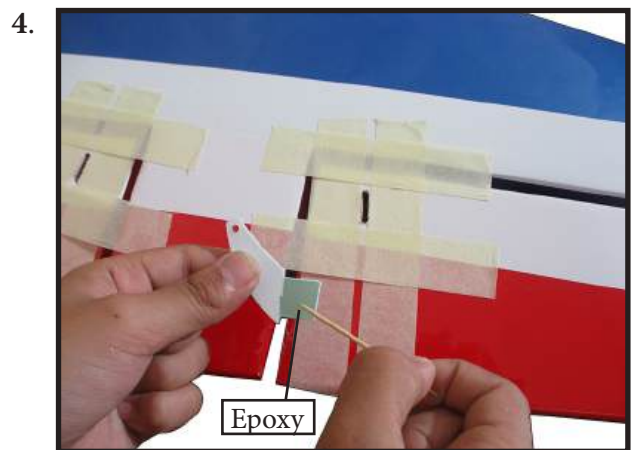
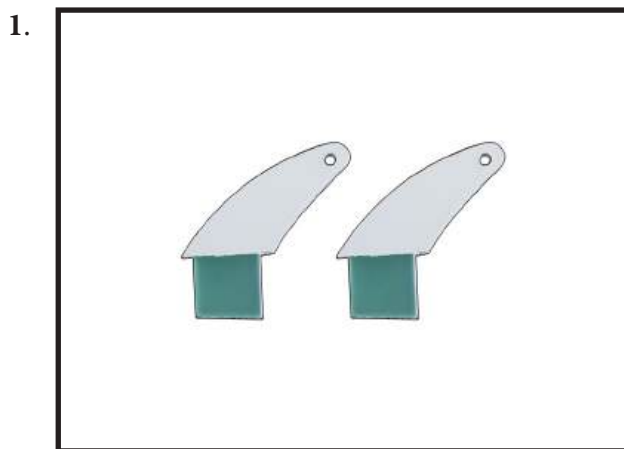

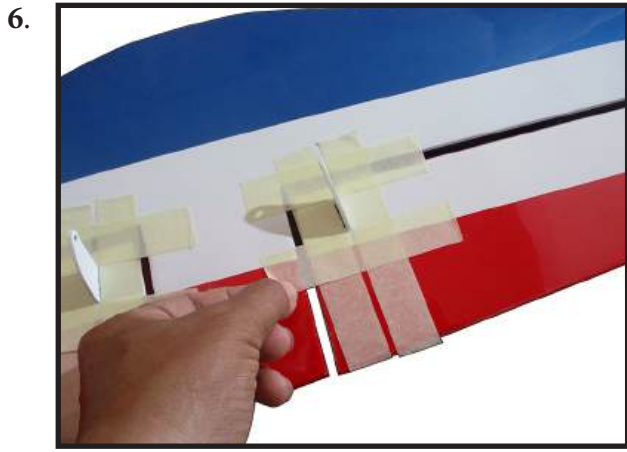

Using a modeling knife, carefully remove the covering at mounting slot of horizontal stabilizer ( both side of fuselage).

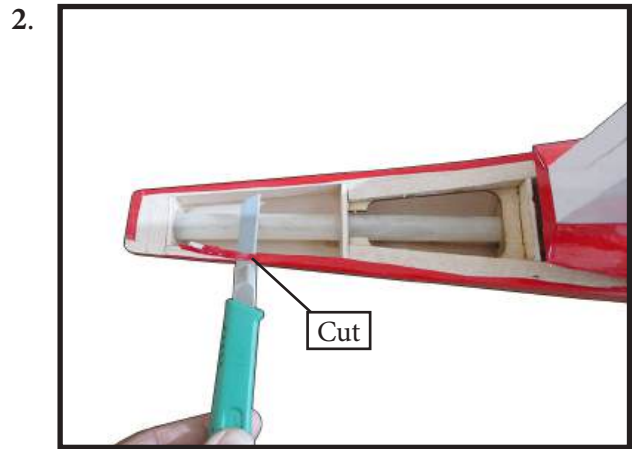
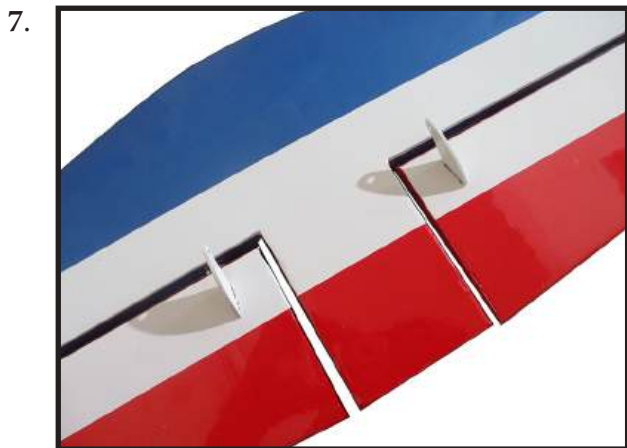

Slide the stabilizer into place in the precut slot in the rear of the fuselage. The stabilizer should be pushed firmly against the front of the slot.

**INSTALLING THE HORIZONTAL STABILIZER**

Using a ruler and a pen, locate the centerline of the horizontal stabilizer, at the trailing edge, and place a mark. Use a triangle and extend this mark, from back to front, across the top of the stabilizer. Also extend this mark down the back of the trailing edge of the stabilizer.

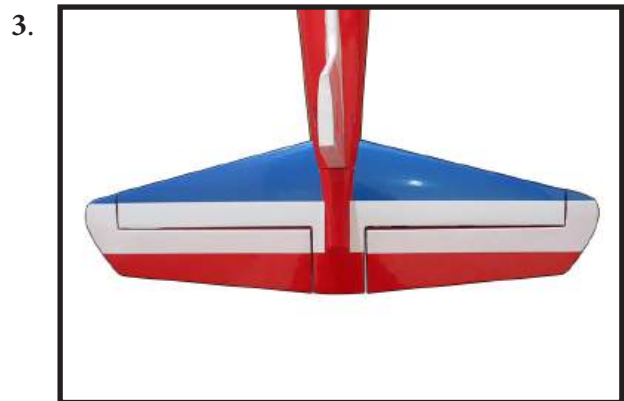

With the stabilizer held firmly in place, use a pen and draw lines onto the stabilizer where it and the fuselage sides meet. Do this on both the right and left sides and top and bottom of the stabilizer.

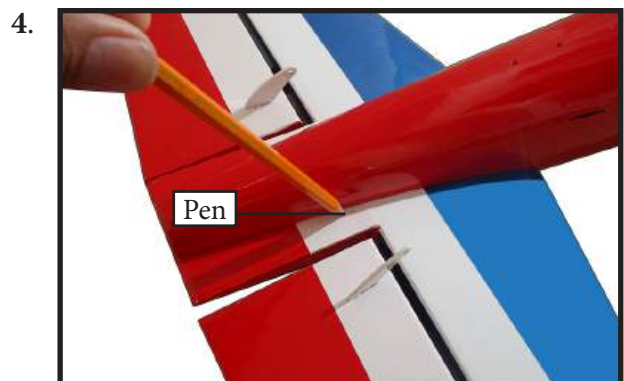
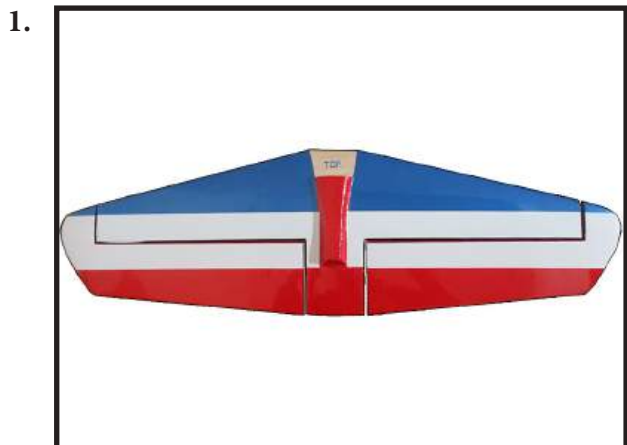

Remove the stabilizer. Using the lines you just drew as a guide, carefully remove the covering from between them using a modeling knife.

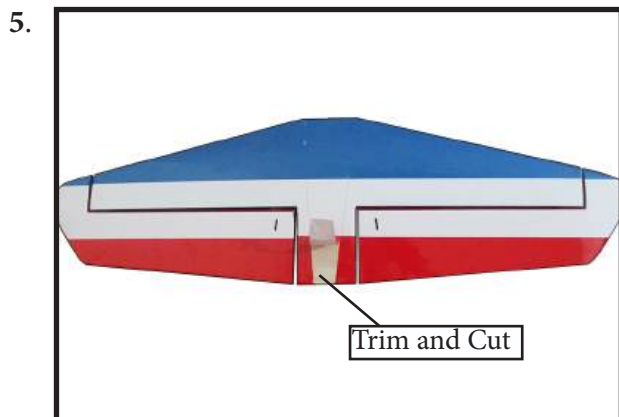

**⚠** When cutting through the covering to remove it, cut with only enough pressure to only cut through the covering itself. Cutting into the balsa structure may weaken it.

Using a modeling knife, carefully remove the covering that overlaps the stabilizer mounting platform sides in the fuselage. Remove the covering from both the top and the bottom of the platform sides.

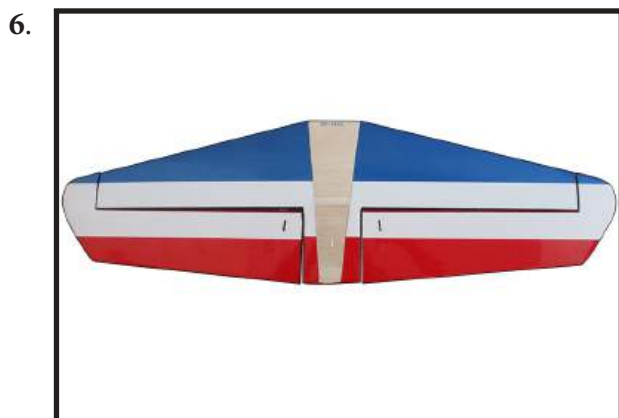

When you are sure that everything is aligned correctly, mix up a generous amount of 30 Minute Epoxy. Apply a thin layer to the top and bottom of the stabilizer mounting area and to the stabilizer mounting platform sides in the fuselage. Slide the stabilizer in place and realign. Double check all of your measurements once more before the epoxy cures. Hold the stabilizer in place with T-pins or masking tape and remove any excess epoxy using a paper towel and rubbing alcohol.

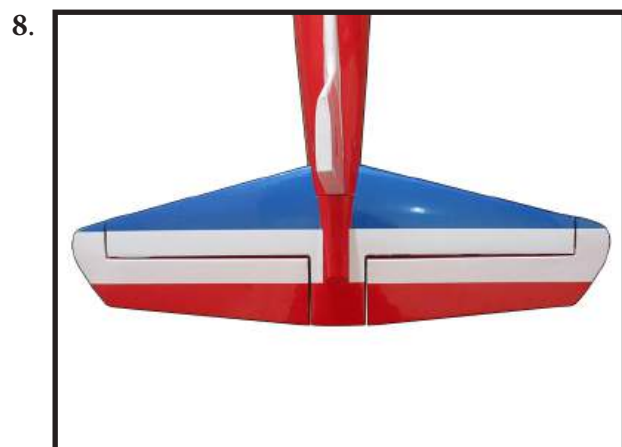
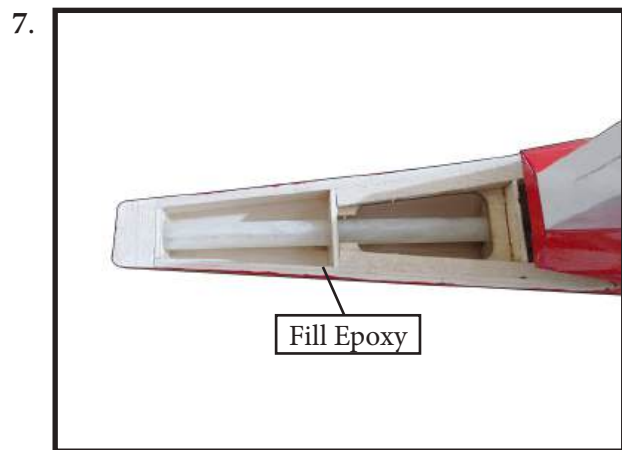

## INSTALL RUDDER CONTROL HORN

Repeat steps to install the rudder control horn as same as steps done for elevator.

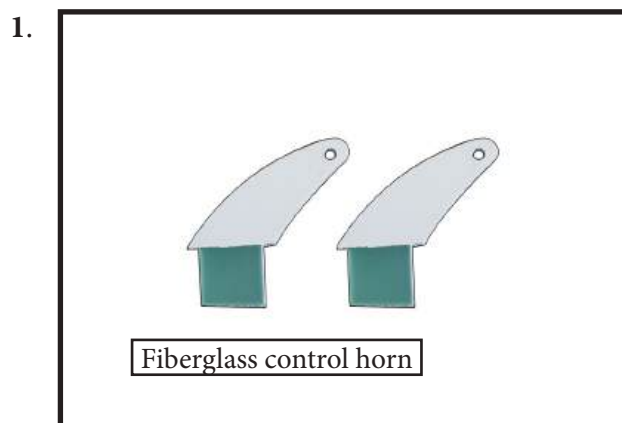

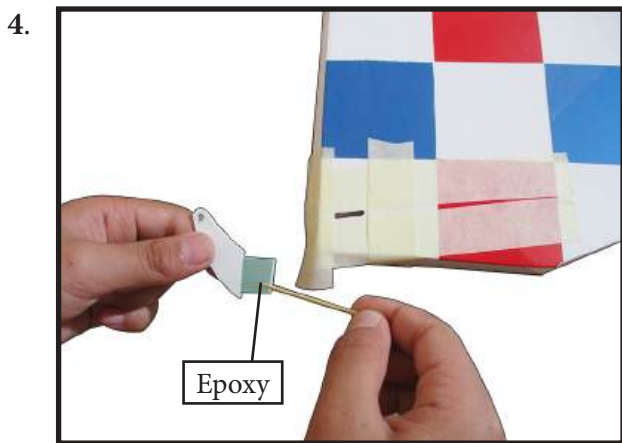
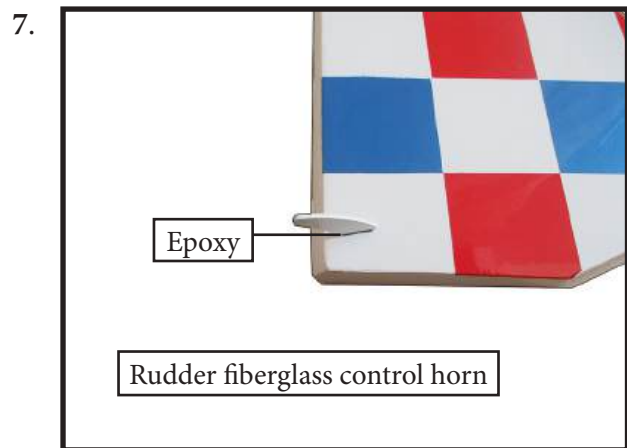
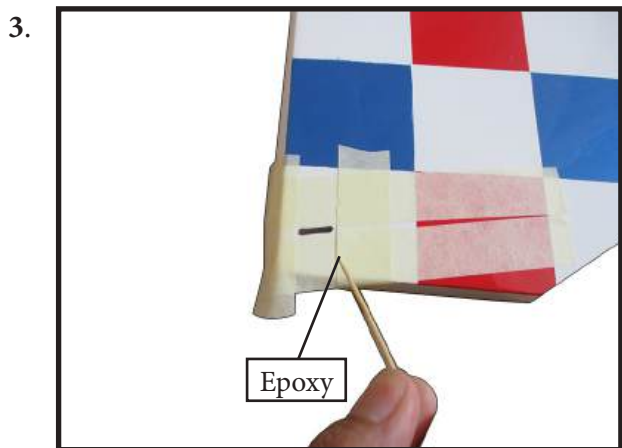
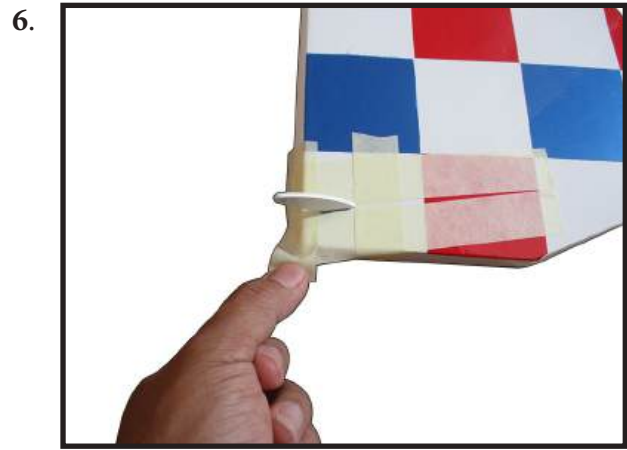
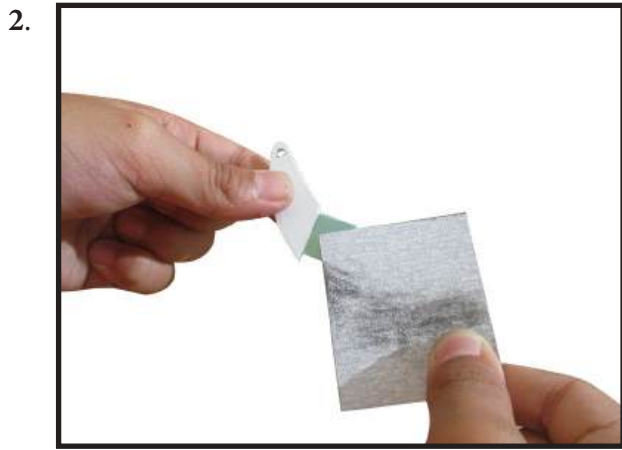

### HINGING THE RUDDER

Glue the top three rudder hinges in place using the same techniques used to hinge the elevator.

The lower hinge will be glued when the fin/rudder assembly is attached to the fuselage.

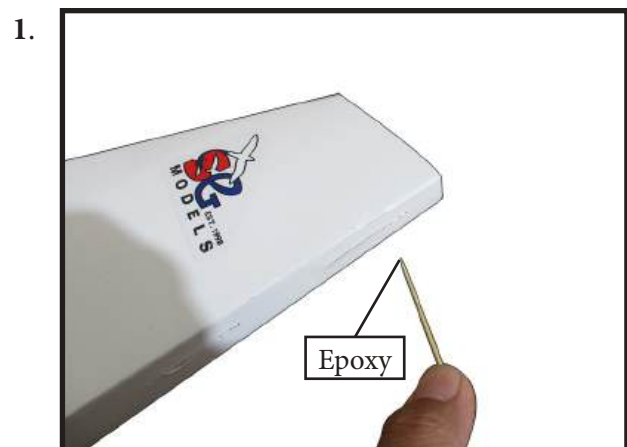

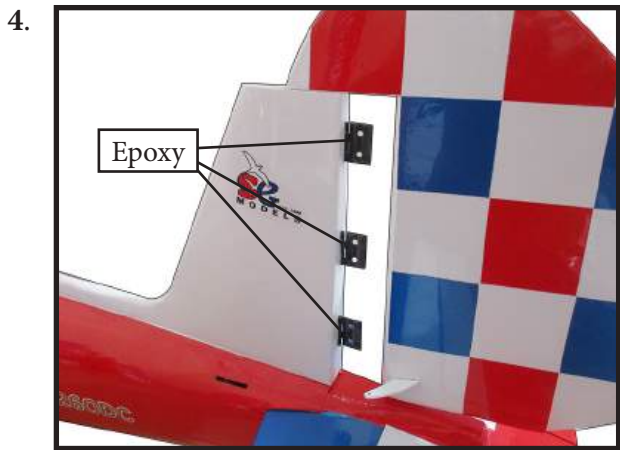
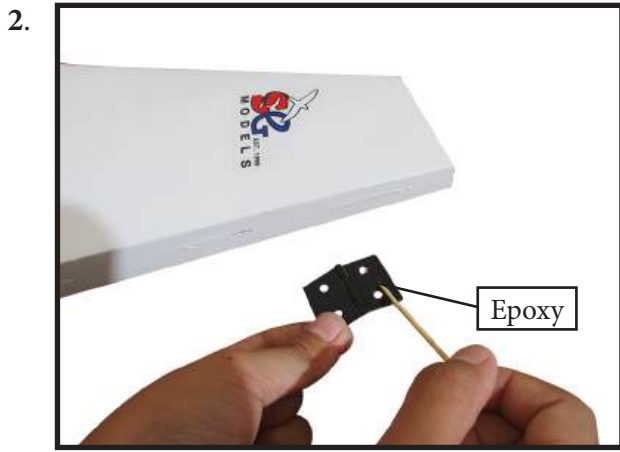

Slide the vertical stabilizer back in place. Using a triangle, check to ensure that the vertical stabilizer is aligned 90° to the horizontal stabilizer.

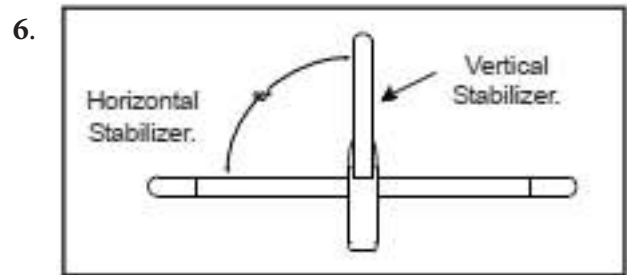

When you are sure that everything is aligned correctly, mix up a generous amount of Flash 30 Minute Epoxy. Apply a thin layer to the mounting slot and to bottom of the vertical stabilizer mounting area. Apply epoxy to the bottom and top edges of the filler block and to the lower hinge also. Set the stabilizer in place and realign. Double check all of your measurements once more before the epoxy cures. Hold the stabilizer in place with T-pins or masking tape and remove any excess epoxy using a paper towel and rubbing alcohol. Allow the epoxy to fully cure before proceeding.

**ELEVATOR PUSHROD HORN INSTALLATION**

Install the elevator control horn using the same method as with the aileron control horns.

Position the elevator control horns on both side of the elevator.

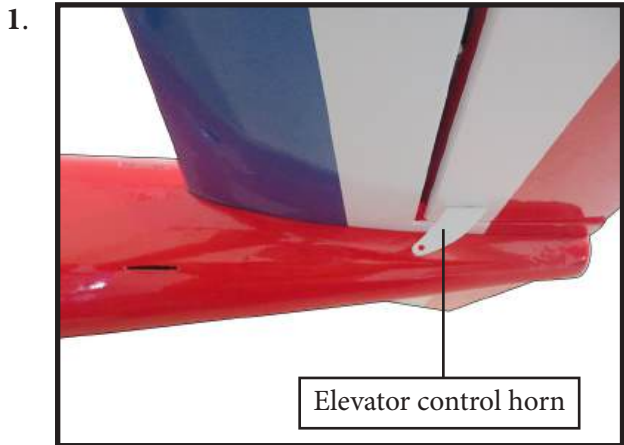

Thread one clevis and M3 lock nut on to each elevator control rod. Thread the horns on until they are flush with the ends of the control rods.

Assemble the elevator and rudder pushrods as shown in images below.

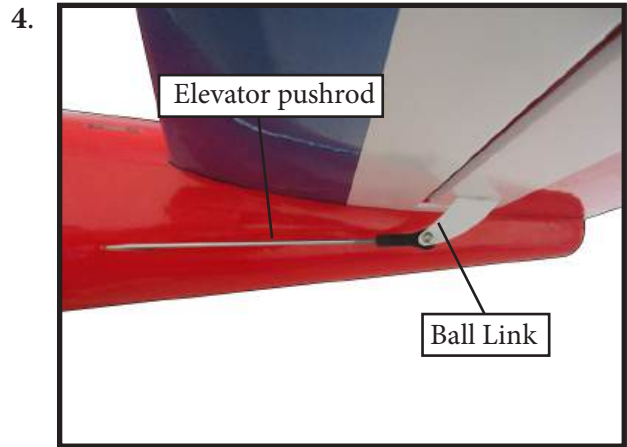
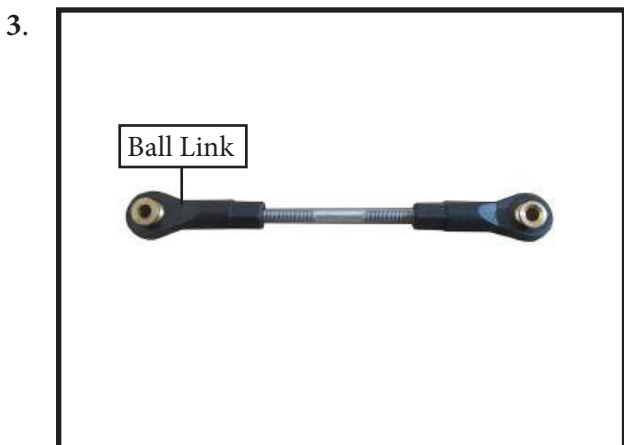
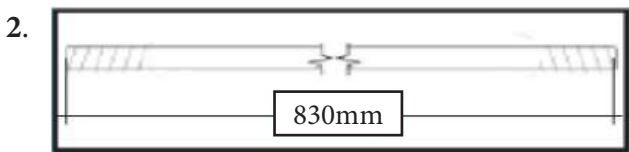

**RUDDER PUSHROD INSTALLATION**

Locate items necessary to install rudder pushrod.

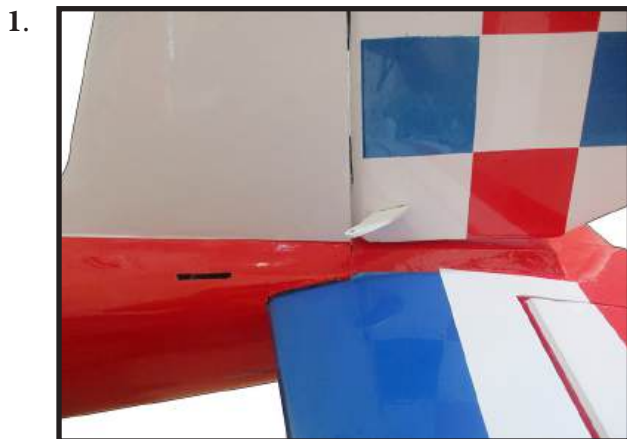

Rudder pushrods assembly as pictures below.

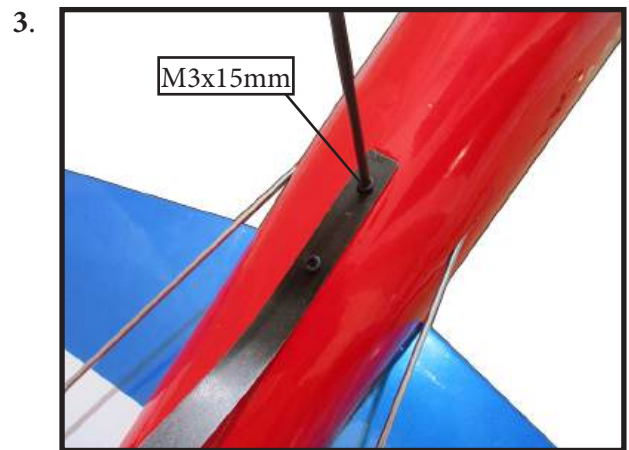
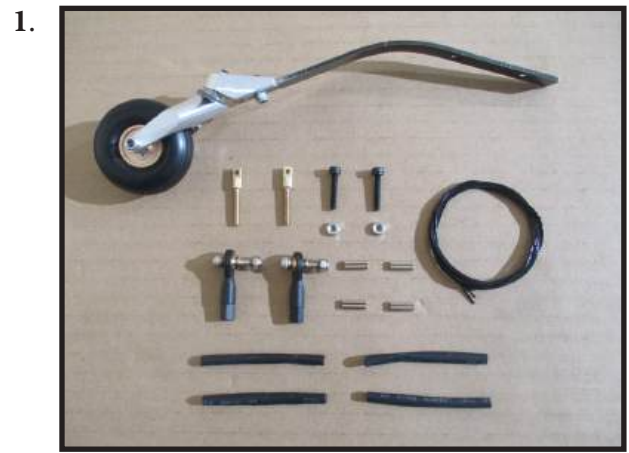
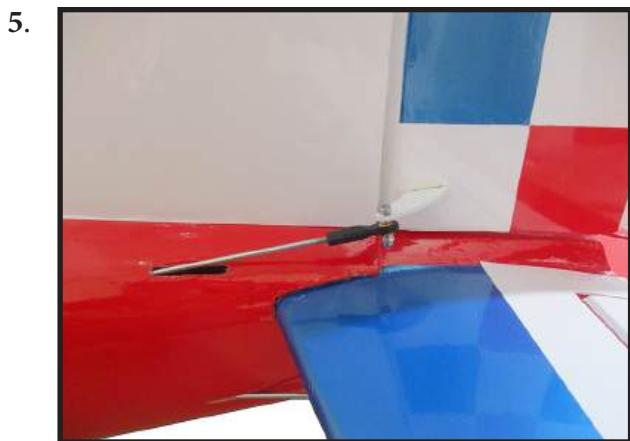
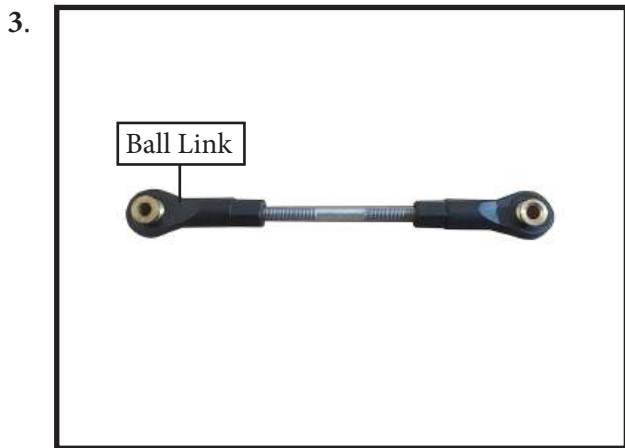
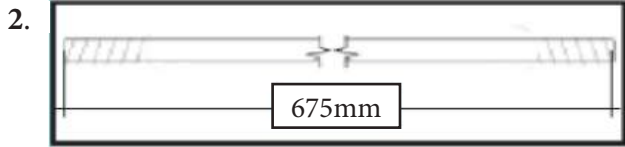

## MOUNTING THE TAIL WHEEL

Locate items necessary to install tail wheel.

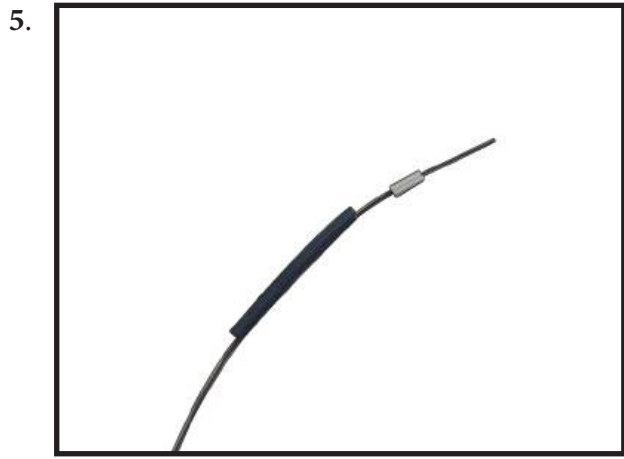

13.



14.



15.



16.



17.



18.



### INSTALL LED BULB FOR FUSELAGE

Please study images below.

The light is located at the back of the same fuselage.

1.



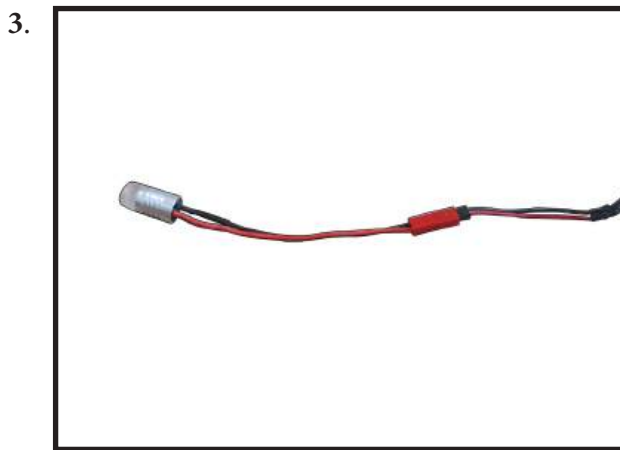
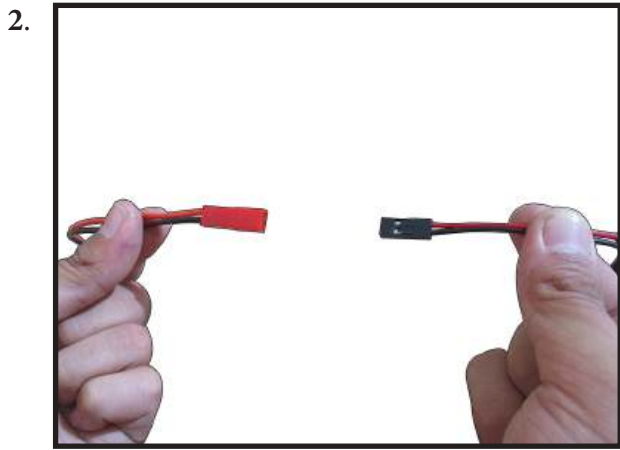

**INSTALLATION COCKPIT, PILOT AND CANOPY**

Locate items necessary to install.

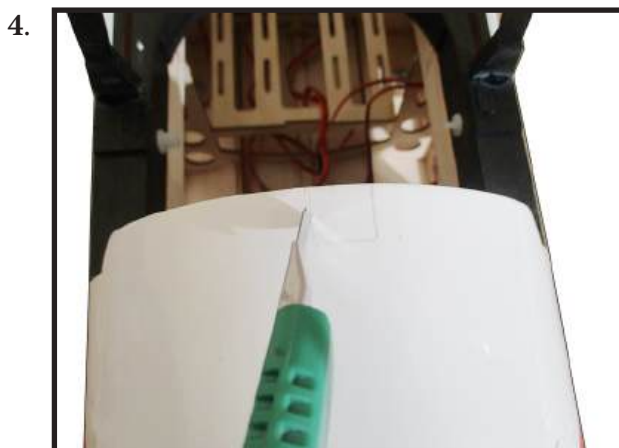
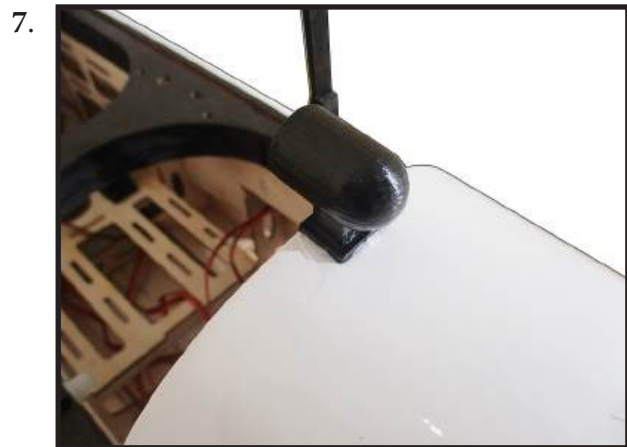
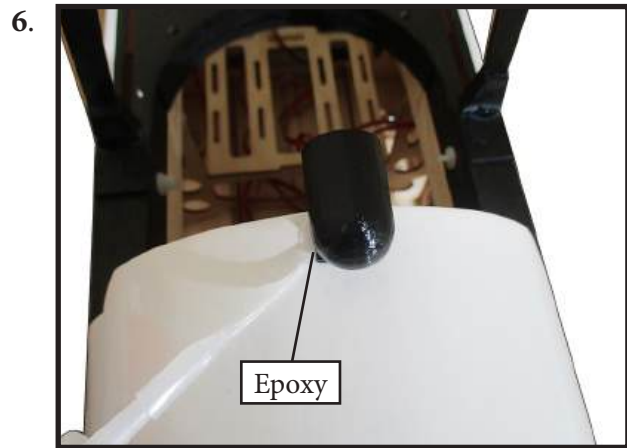
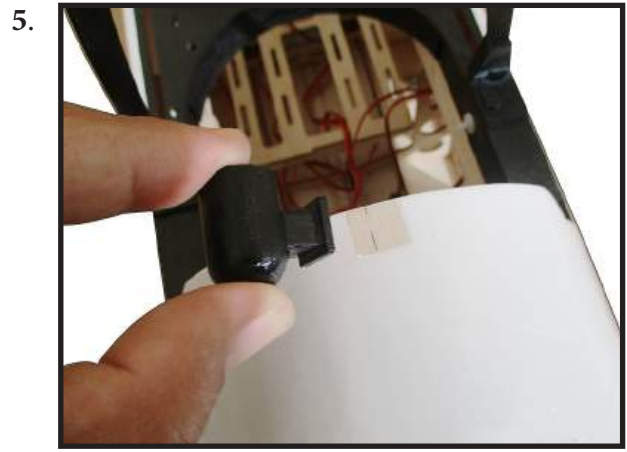
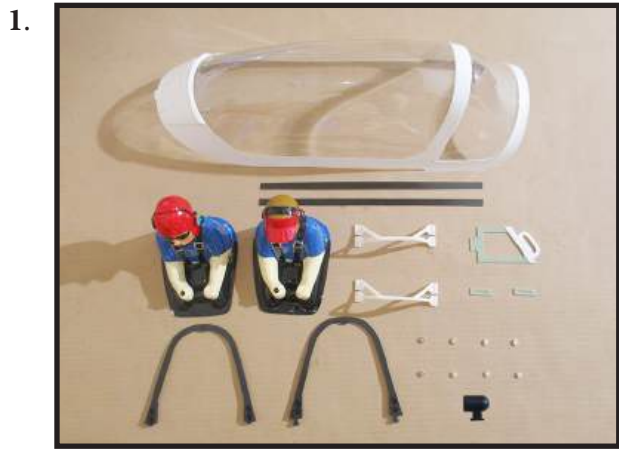

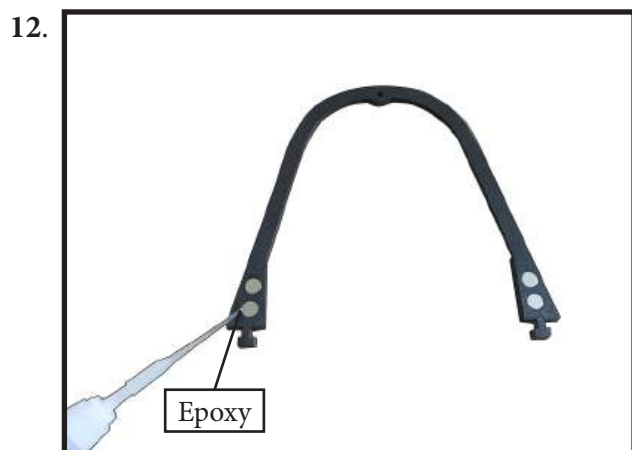
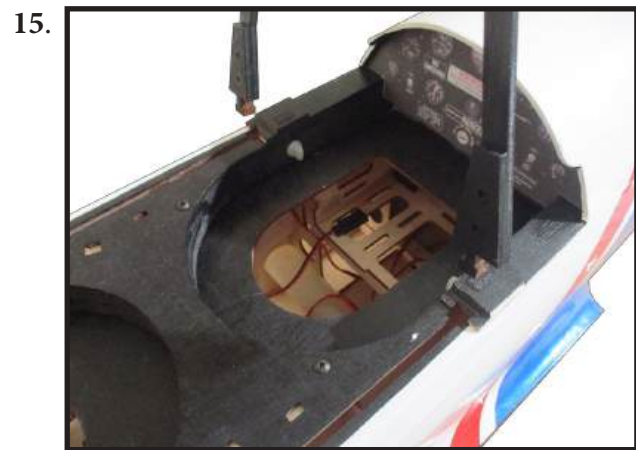
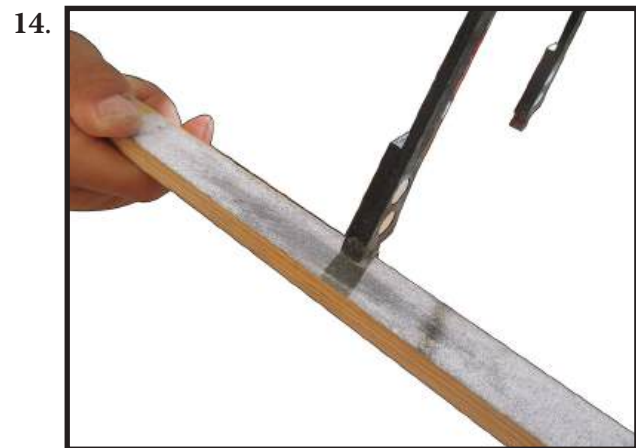
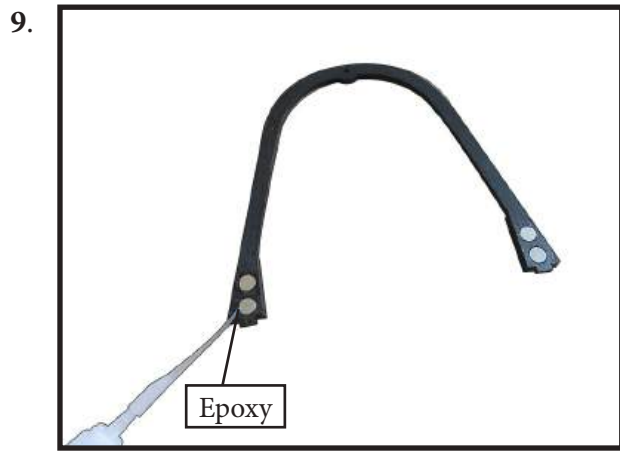

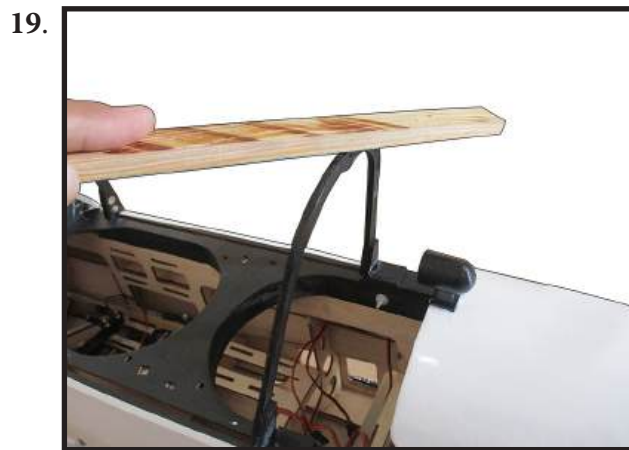
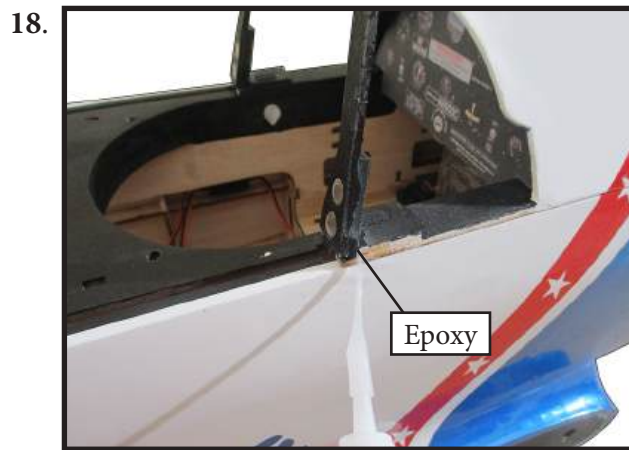

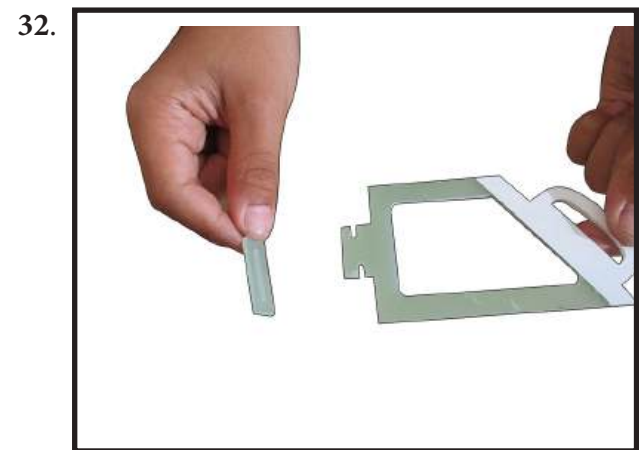
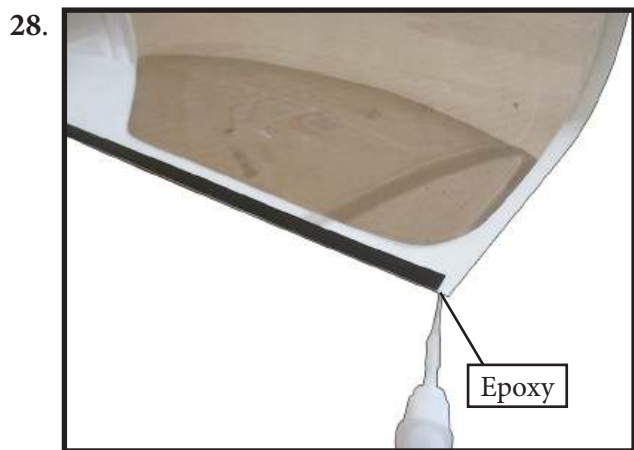
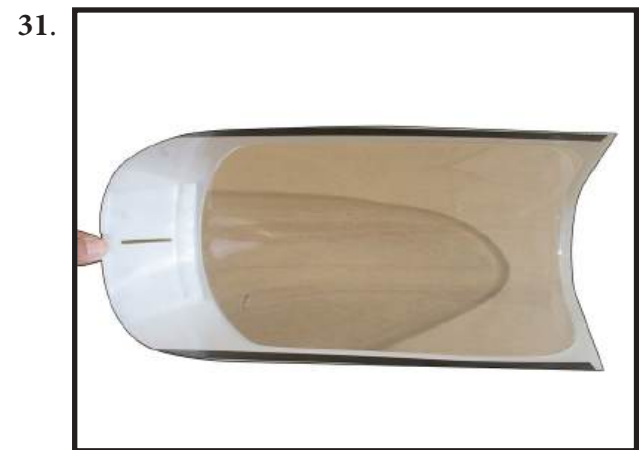
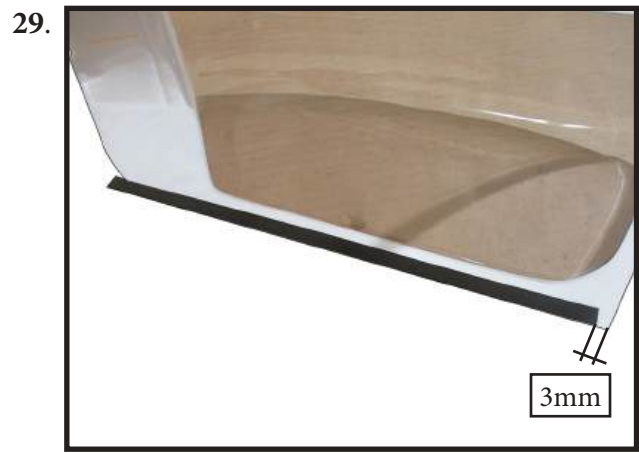

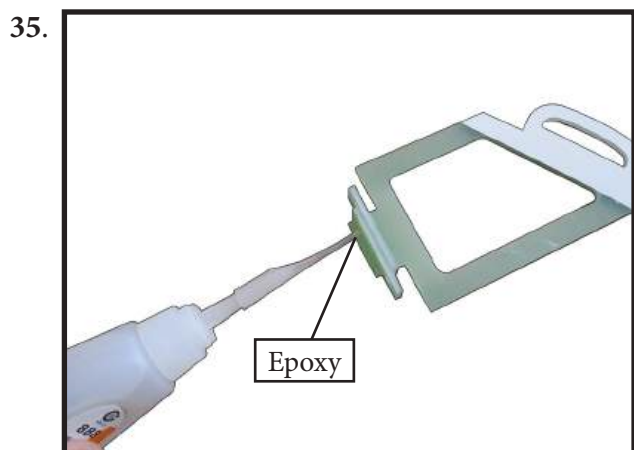
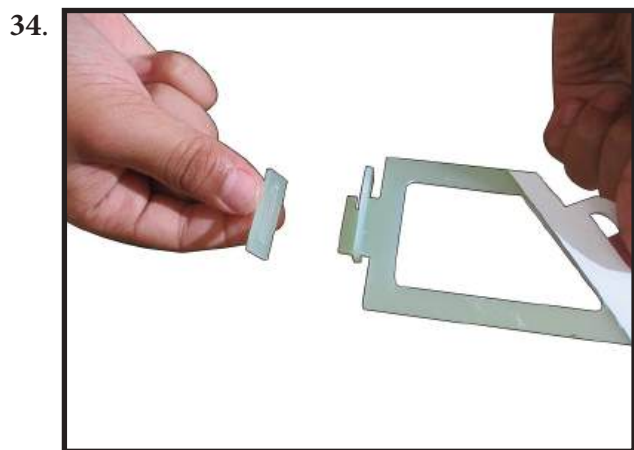
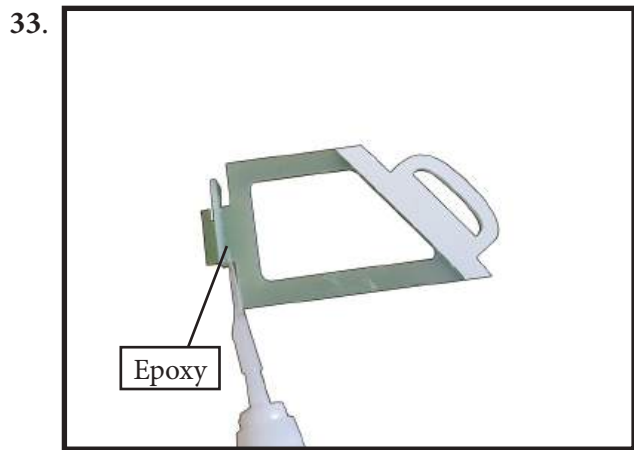

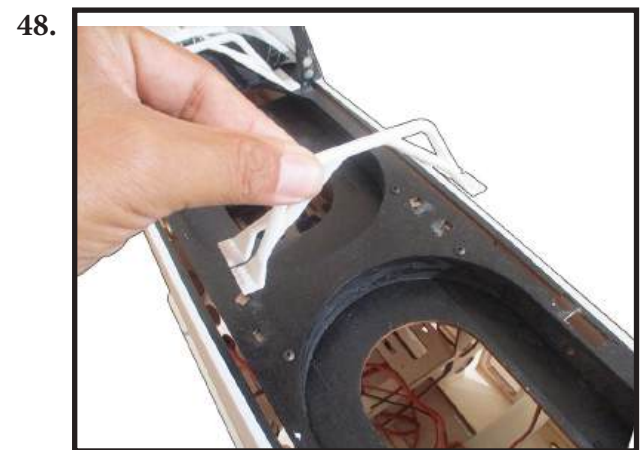
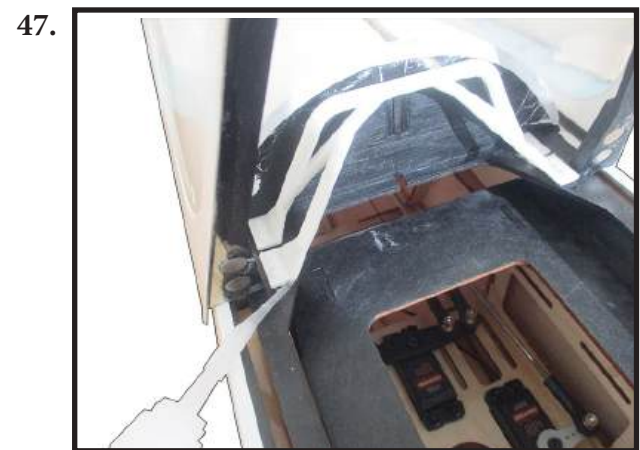
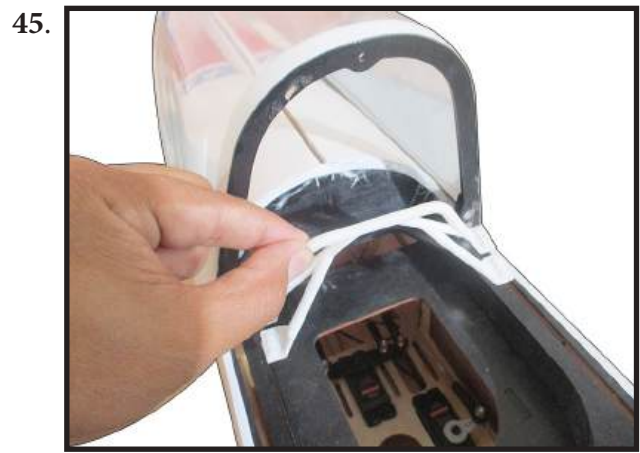
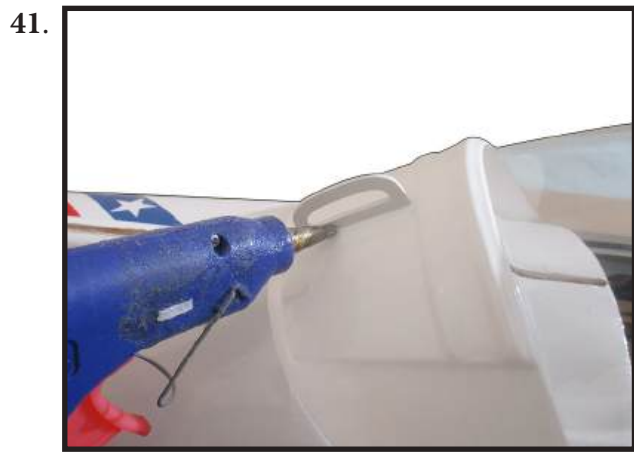

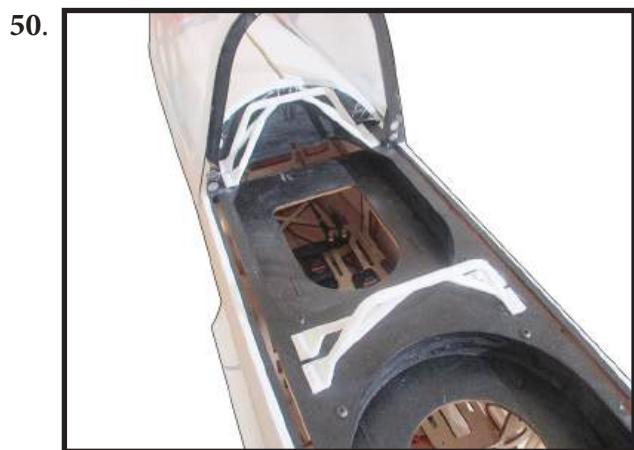
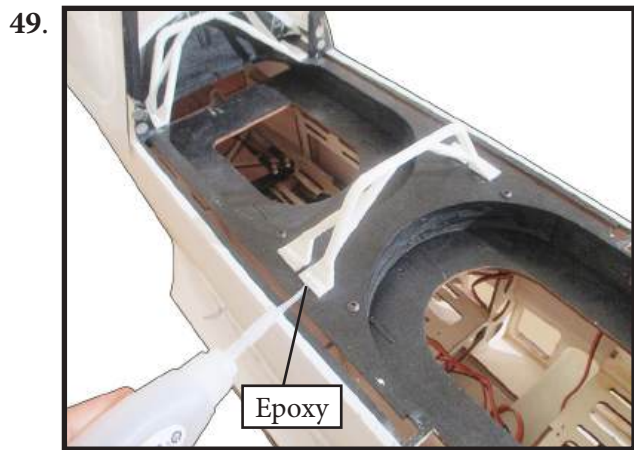

**INSTALLING BATTERY - RECEIVER**

Plug the servo leads and the switch lead into the receiver. Plug the battery pack lead into the switch also.

Wrap the receiver and battery pack in the protective foam rubber to protect them from vibration.

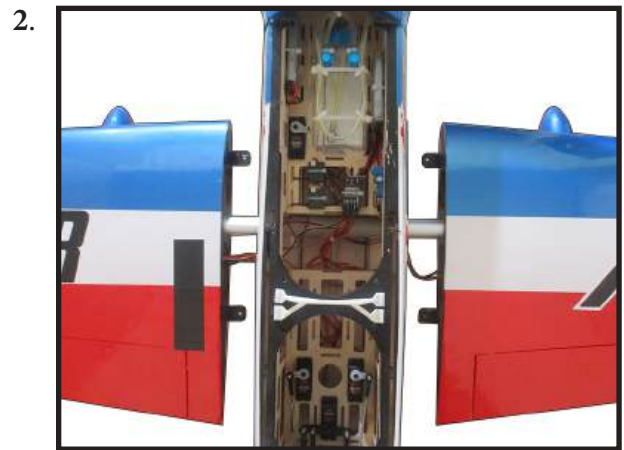
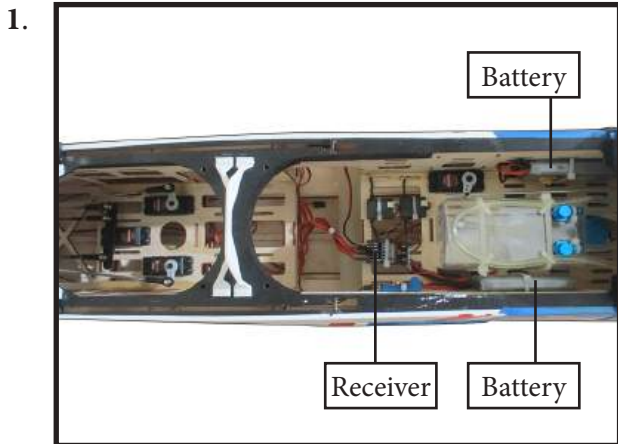

**ATTACHMENT WING-FUSELAGE**

Attach the aluminium tube into fuselage.

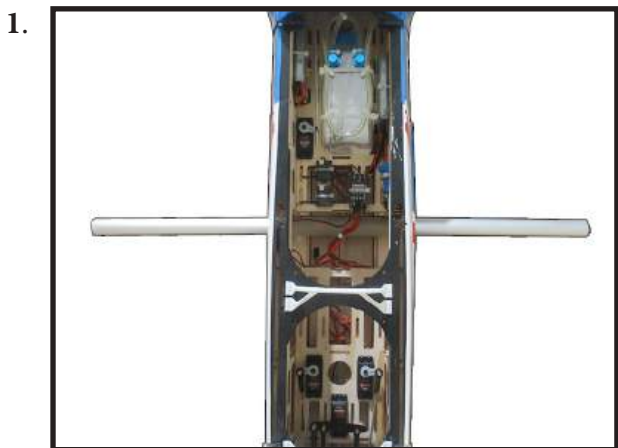

Insert two lower wing panels as pictures below..

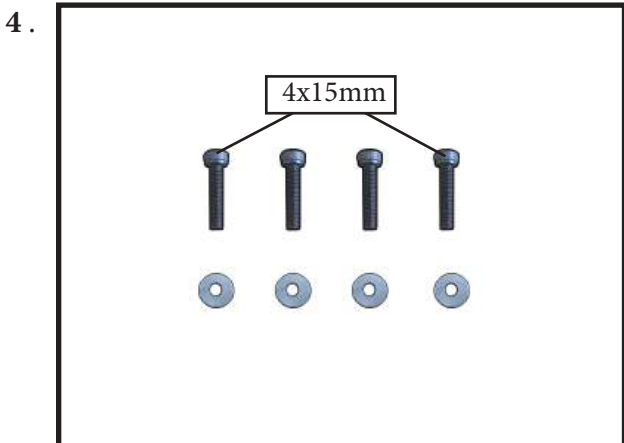

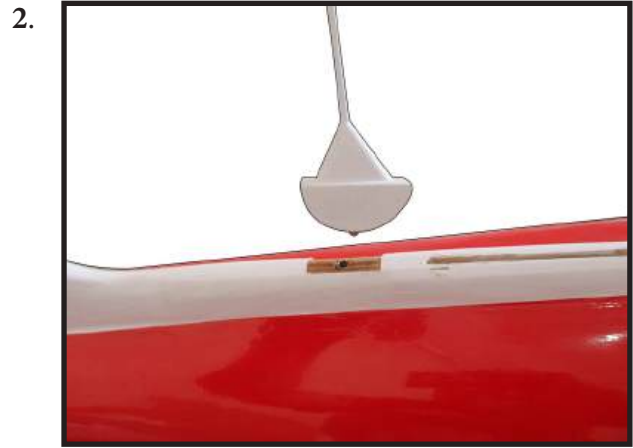
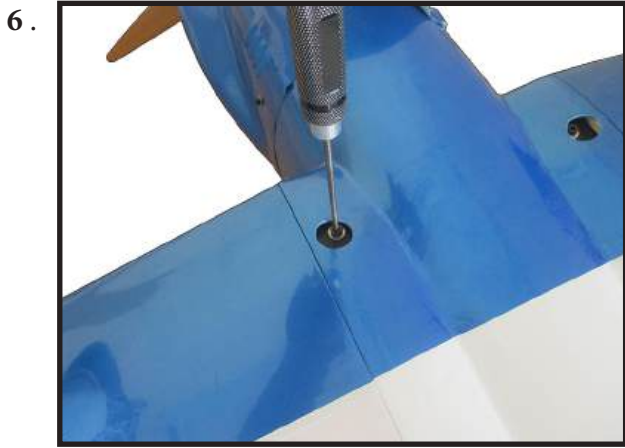

### INSTALLING ANTENNAS

Antennas feature banana plugs for easy installation and removal.

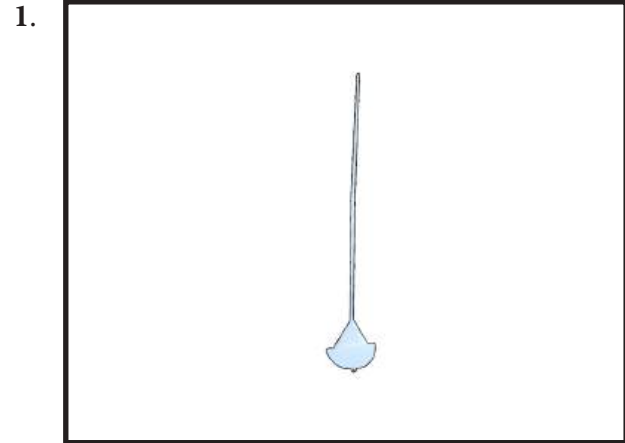

### APPLY THE DECALS

If all the decals are pre-cut and ready to stick. Please be certain the model is clean and free from oily fingerprints and dust. Position decal on the model where desired, using the photos on the box and aid in their location.

If all the decals are not precut, please use scissors or a sharp hobby knife to cut the decals from the sheet. Please be certain the model is clean and free from oily fingerprints and dust. Position decal on the model where desired, using the photos on the box and aid in their location.

### BALANCING - DO NOT SKIP THIS !

It is **critical** that your airplane be balanced correctly. Improper balance will cause your plane to lose control and crash. THE CENTER OF GRAVITY IS LOCATED **150MM** BACK FROM THE LEADING EDGE OF THE WING AT THE WING ROOT.

Landing gear should be in the "up" retracted position when balancing.

Mount the wing to the fuselage. Place a piece of masking tape on the top of each wing 150mm back from the leading edge at the wing root.

With the model inverted, place your fingers on the masking tape and carefully lift the plane. This is the point at which your model should balance for your first flights. Later, you may wish to experiment by shifting the balance up to 10mm forward or back to change the flying characteristics. Moving the balance forward may improve the smoothness and arrow-like tracking, but it may then require more speed for take off and make it more difficult to slow down for landing. Moving the balance aft makes the model more agile with a lighter and snappier "feel". In any case, please start at the location we recommend.

\* If possible, first attempt to balance the model by changing the position of the receiver battery and receiver. If you are unable to obtain good balance by doing so, then it will be necessary to add weight to the nose or tail to achieve the proper balance point.

With the wings attached to the fuselage, all parts of the model installed ( ready to fly), and empty fuel tanks, hold the model at the marked balance point with the stabilizer level.

Lift the model. If the tail drops when you lift, the model is "tail heavy" and you must add weight\* to the nose. If the nose drops, it is "nose heavy" and you must add weight\* to the tail to balance.

1.

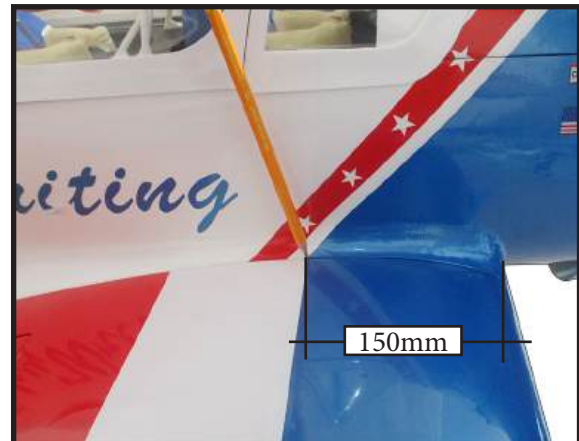

## CONTROL THROWS

<p><b>Ailerons:</b></p> <p>High Rate :            Up : 30 mm            Down : 30 mm</p> <p>Low Rate :            Up : 25 mm            Down : 25 mm</p>	<p><b>Rudder:</b></p> <p>High Rate :            Right : 90 mm            Left : 90 mm</p> <p>Low Rate :            Right : 80 mm            Left : 80 mm</p>
<p><b>Elevator:</b></p> <p>High Rate :            Up : 40 mm            Down : 40 mm</p> <p>Low Rate :            Up : 35 mm            Down : 35 mm</p>	<p><b>Flap:</b></p> <p>Mid : 40mm            Full : 70mm</p>

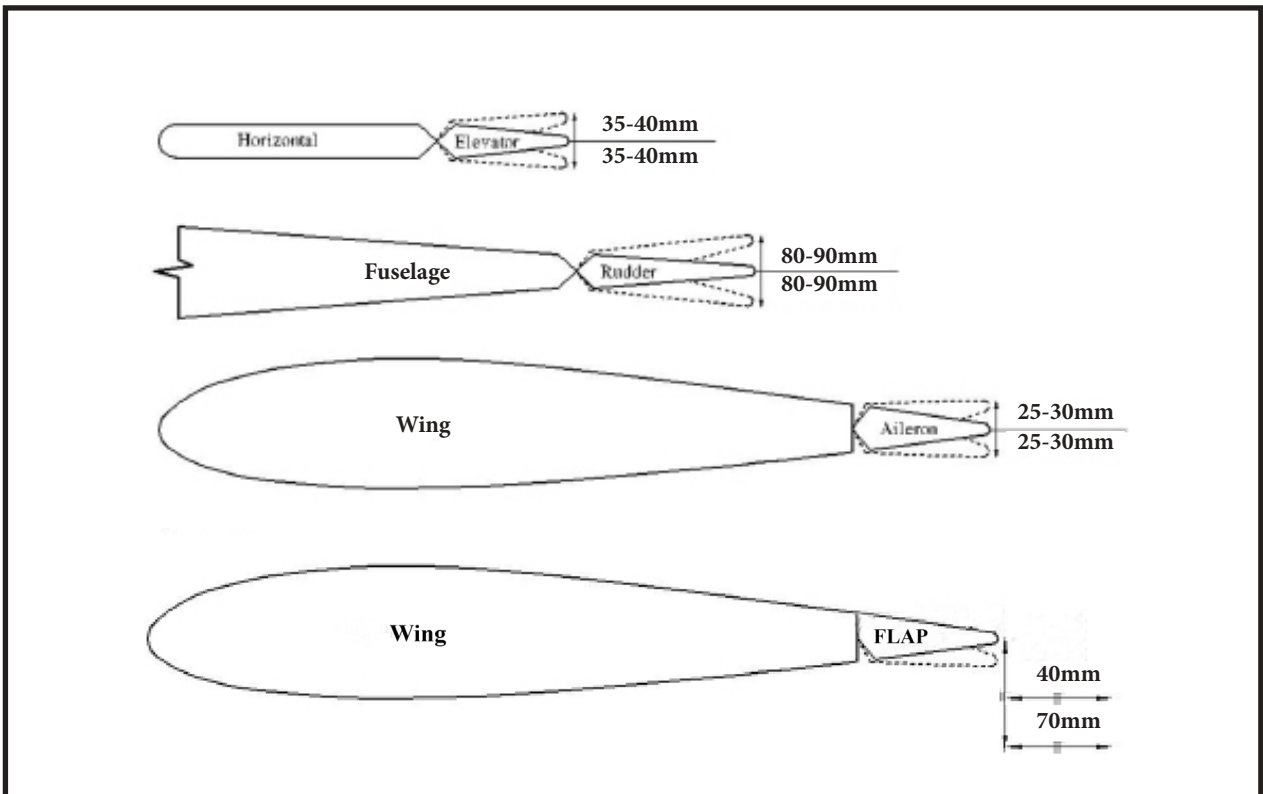

## FLIGHT PREPARATION

Check the operation and direction of the elevator, rudder, ailerons and throttle.

□ A) Plug in your radio system per the manufacturer's instructions and turn everything on.

□ B) Check the elevator first. Pull back on the elevator stick. The elevator halves should move up. If it they do not, flip the servo reversing switch on your transmitter to change the direction.

□ C) Check the rudder. Looking from behind the airplane, move the rudder stick to the right. The rudder should move to the right. If it does not, flip the servo reversing switch on your transmitter to change the direction.

□ D) Check the throttle. Moving the throttle stick forward should open the carburetor barrel. If it does not, flip the servo reversing switch on your transmitter to change the direction.

□ E) From behind the airplane, look at the aileron on the right wing half. Move the aileron stick to the right. The right aileron should move up and the other aileron should move down. If it does not, flip the servo reversing switch on your transmitter to change the direction.

## PREFLIGHT CHECK

□ 1) Completely charge your transmitter and receiver batteries before your first day of flying.

□ 2) Check every bolt and every glue joint in the **Ghostwriter Super Chipmunk 81" wingspan ARF 35-40cc** to ensure that everything is tight and well bonded.

□ 3) Double check the balance of the airplane. Do this with the fuel tank empty.

□ 4) Check the control surfaces. All should move in the correct direction and not bind in any way.

□ 5) If your radio transmitter is equipped with dual rate switches double check that they are on the low rate setting for your first few flights.

□ 6) Check to ensure the control surfaces are moving the proper amount for both low and high rate settings.

□ 7) Check the receiver antenna. It should be fully extended and not coiled up inside the fuselage.

□ 8) Properly balance the propeller. An out of balance propeller will cause excessive vibration which could lead to engine and/or airframe failure.

*We wish you many safe and enjoyable flights*  
**with your Ghostwriter Super Chipmunk 81" wingspan ARF 35-40cc.**

---

*If you have any queries, or are interested in our products,  
please feel free to contact us*

**Factory :** 12/101A - Hamlet 4 - Le Van Khuong Street - Dong Thanh Ward -  
Hoc Mon District - Ho Chi Minh City - Viet Nam.

**Office :** 62/8 Ngo Tat To Street - Ward 19 - Binh Thanh District - Ho Chi Minh  
City - Viet Nam

**Phone :** 848 - 86622289 or 848- 36018777

**Website :** [www.SeagullModels.com](http://www.SeagullModels.com)

**Email :** [Sales@seagullmodels.com](mailto:Sales@seagullmodels.com)

**Facebook :** [www.facebook.com/SeaGullModels](http://www.facebook.com/SeaGullModels).