



L-4 Grasshopper 90 inches

Code : SEA 325

ASSEMBLY MANUAL



Specifications:

Wingspan----- 90.0 in (228.6 cm).
Wing area----- 1182.3 sq.ins (76.3 sq.dm).
Weight----- 13.2 lbs (6.0 kg).
Length----- 56.8 in (144.2 cm).
Engine/Motor size----- 20cc gasoline.
Radio----- 4 channels with 5 servos.

INTRODUCTION

Thank you for choosing the **L-4 Grasshopper 90 inches** ARTF by **SG MODELS**. The **L-4 Grasshopper 90 inches** was designed with the intermediate/advanced sport flyer in mind. It is a semi scale airplane which is easy to fly and quick to assemble. The airframe is conventionally built using balsa, plywood to make it stronger than the average ARTF, yet the design allows the aeroplane to be kept light. You will find that most of the work has been done for you already. The motor mount has been fitted and the hinges are pre-installed. Flying the **L-4 Grasshopper 90 inches** is simply a joy.

This instruction manual is designed to help you build a great flying aeroplane. Please read this manual throughly before starting assembly of your **L-4 Grasshopper 90 inches** Use the parts listing below to indentify all parts.

WARNING

Please be aware that this aeroplane is not a toy and if assembled or used incorrectly it is capable of causing injury to people or property. WHEN YOU FLY THIS AEROPLANE YOU ASSUME ALL RISK & REPONSIBILITY.

If you are inexperienced with basic R/C flight we strongly recommend you contact your R/C supplier and join your local R/C model Flying Club. R/C Model Flying Clubs offer a variety of training procedures designed to help the new pilot on his way to successful R/C flight. They will also be able to advise on any insurance and safety regulations that may apply.

KIT CONTENTS

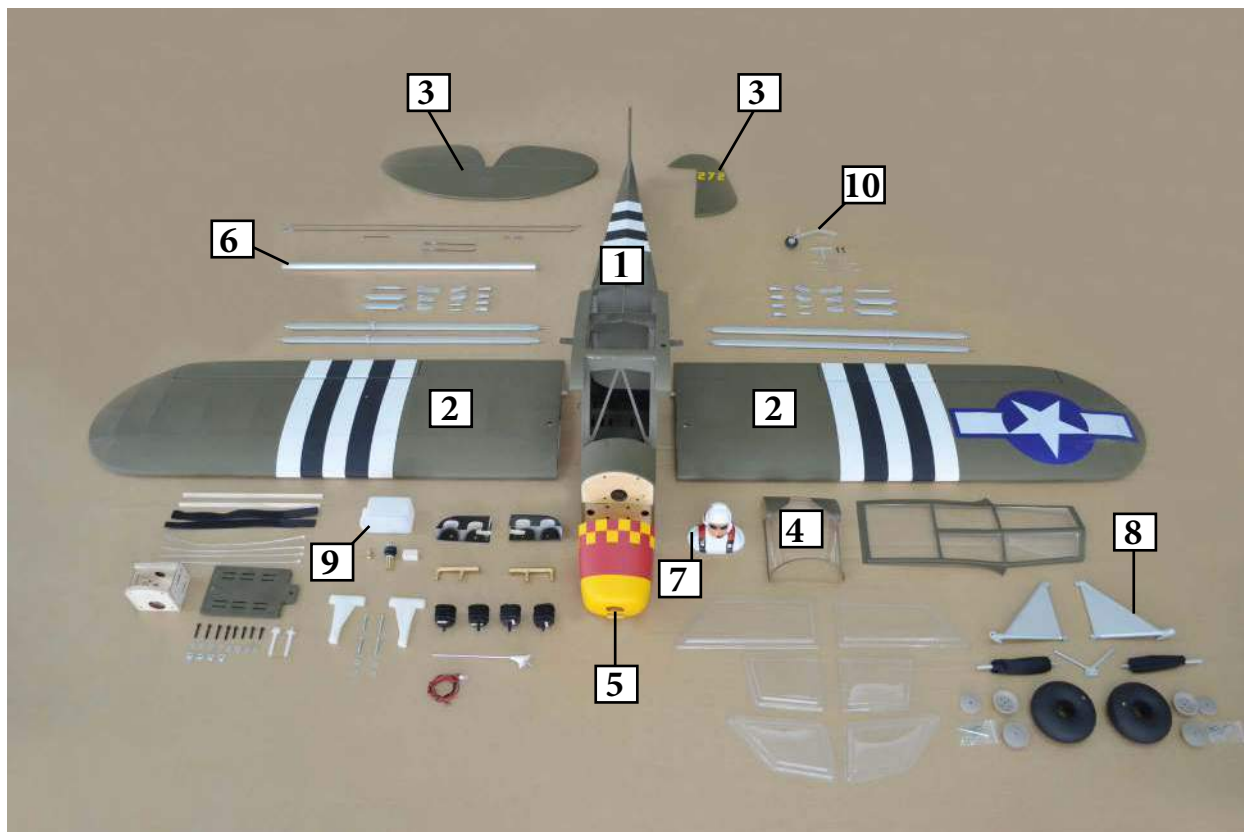

KIT CONTENTS

SEA325 L-4 Grasshopper 90 inches

1. Fuselage
2. Wing set (2)
3. Tail set (2)
4. Canopy
5. Cowling
6. Wing tube
7. Pilot
8. landing gear
9. Fuel tank
10. Tail wheel

ADDITIONAL ITEMS REQUIRED

- 20cc gasoline engine.
- Computer radio 4 channel with 5 servos.
- Glow plug to suit engine.
- Propeller to suit engine 20x8-20x10.
- Protective foam rubber for radio system.

TOOLS & SUPPLIES NEEDED

- Thin cyanoacrylate glue.
- Medium cyanoacrylate glue.
- 30 minute epoxy.
- 5 minute epoxy.
- Hand or electric drill.
- Assorted drill bits.
- Modelling knife.
- Straight edge ruler.
- 2mm ball driver.
- Phillips head screwdriver.
- 220 grit sandpaper.
- 90° square or builder's triangle.
- Wire cutters.
- Masking tape & T-pins.
- Thread-lock.
- Paper towels.

HINGING THE AILERON

Note: *The control surfaces, including the ailerons, elevators, and rudder, are prehinged with hinges installed, but the hinges are not glued in place. It is imperative that you properly adhere the hinges in place per the steps that follow using a high-quality thin C/A glue.*

Carefully remove the aileron from one of the wing panels. Note the position of the hinges.

1.

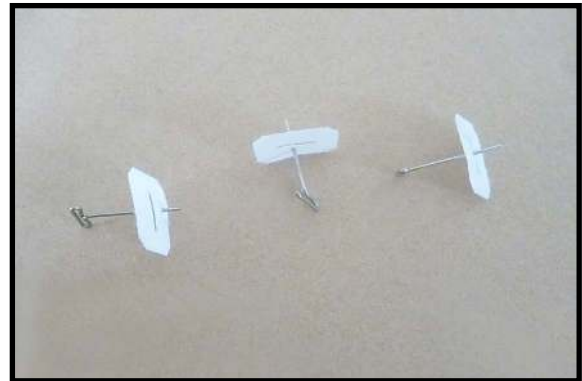

Remove each hinge from the wing panel and aileron and place a T-pin in the center of each hinge. Slide each hinge into the wing panel until the T-pin is snug against the wing panel. This will help ensure an equal amount of hinge is on either side of the hinge line when the aileron is mounted to the aileron.

2.

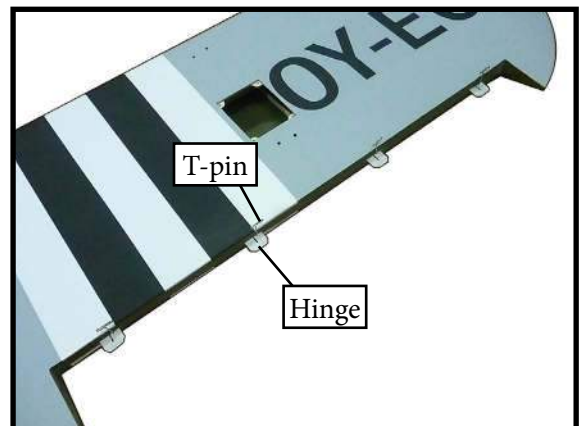

Slide the wing panel on the aileron until there is only a slight gap. The hinge is now centered on the wing panel and aileron. Remove the T-pins and snug the aileron against the wing panel. A gap of 1/64" or less should be maintained between the wing panel and aileron.

Deflect the aileron and completely saturate each hinge with thin C/A glue. The ailerons front surface should lightly contact the wing during this procedure. Ideally, when the hinges are glued in place, a 1/64" gap or less will be maintained throughout the length of the aileron to the wing panel hinge line.

NOTE : The hinge is constructed of a special material that allows the C/A to wick or penetrate and distribute throughout the hinge, securely bonding it to the wood structure of the wing panel and aileron.

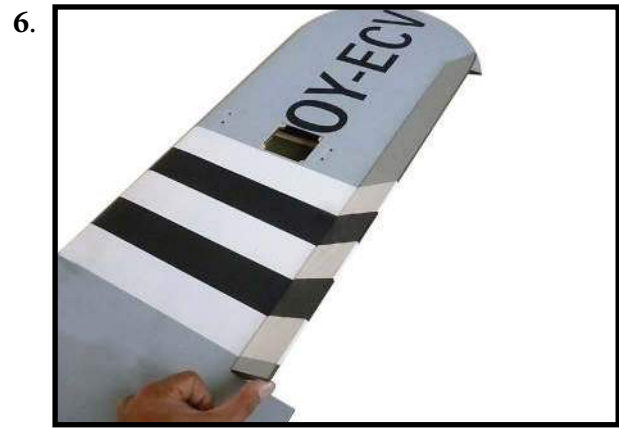
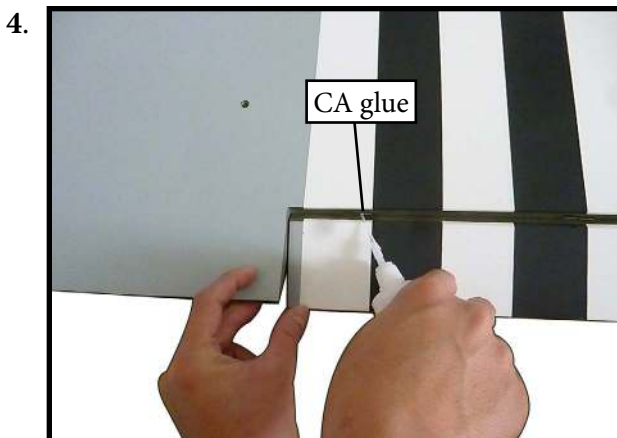
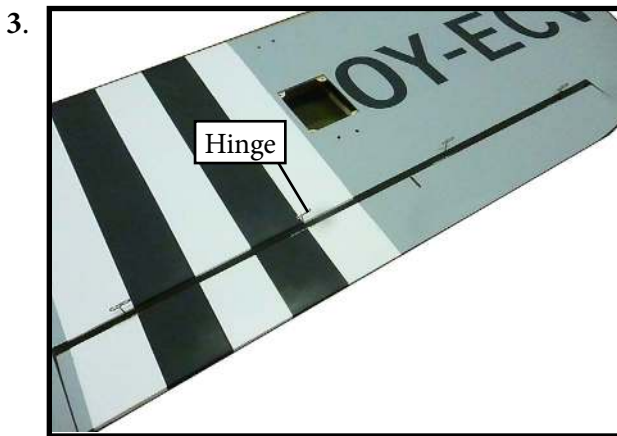

Turn the wing panel over and deflect the aileron in the opposite direction from the opposite side. Apply thin C/A glue to each hinge, making sure that the C/A penetrates into both the aileron and wing panel.

Using C/A remover/debonder and a paper towel, remove any excess C/A glue that may have accumulated on the wing or in the aileron hinge area.

Repeat this process with the other wing panel, securely hinging the aileron in place.

After both ailerons are securely hinged, firmly grasp the wing panel and aileron to make sure the hinges are securely glued and cannot be pulled out. Do this by carefully applying medium pressure, trying to separate the aileron from the wing panel. Use caution not to crush the wing structure.



Note : Work the aileron up and down several times to "work in" the hinges and check for proper movement.

**INSTALL THE AILERONS
CONTROL HORN**

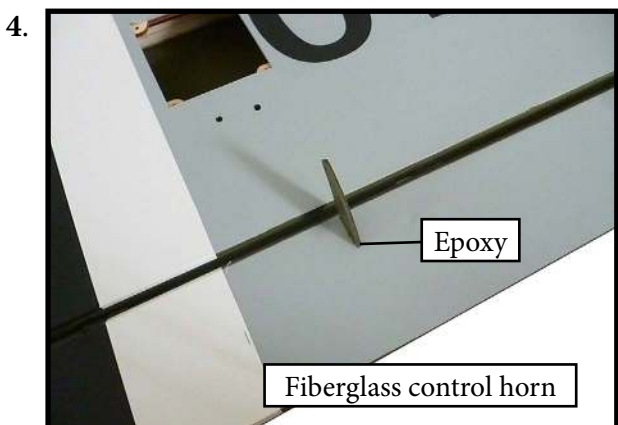
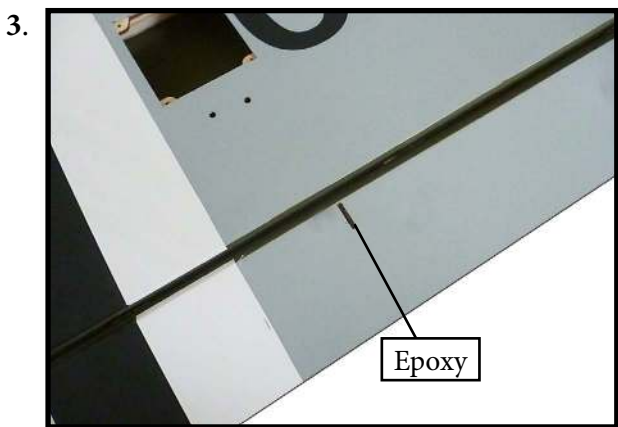
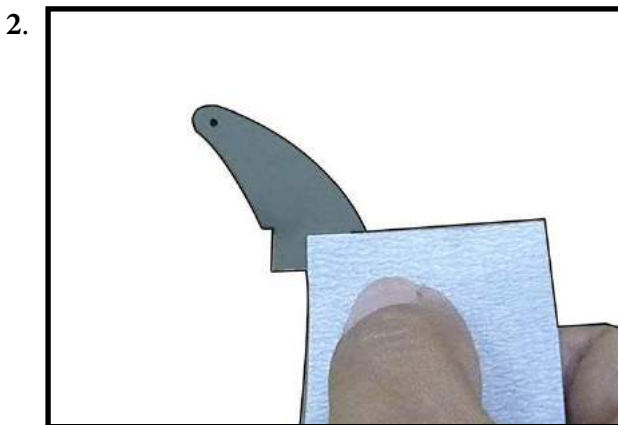
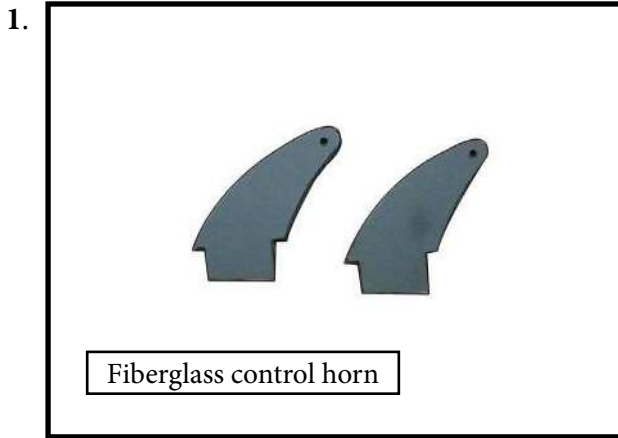

INSTALLING THE AILERON SERVOS

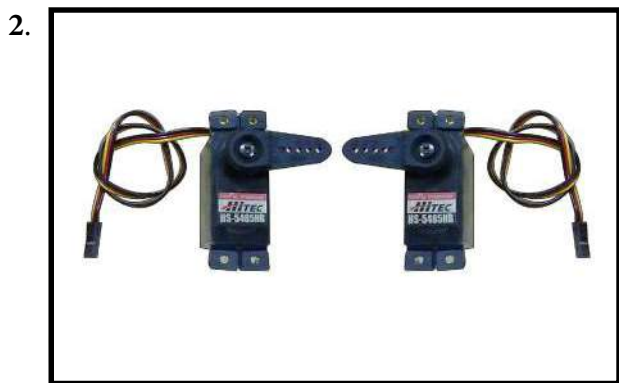
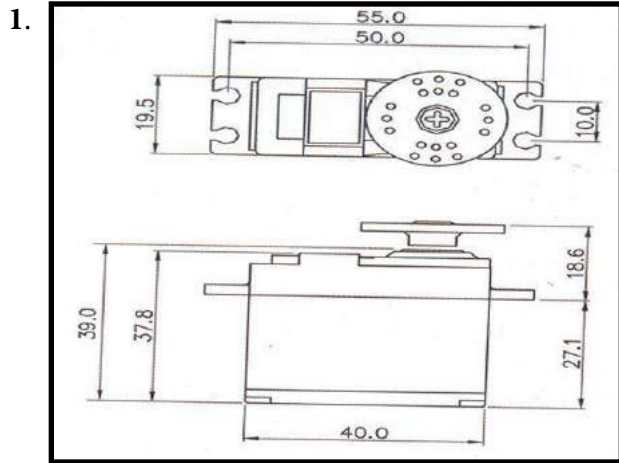

Minimum servo spec.
Torque : 80 oz-in (5.8 kg-cm) @ 4.8V;
100 oz-in (7.2 kg-cm) @ 6.0V

! Because the size of servos differ, you may need to adjust the size of the precut opening in the mount. The notch in the sides of the mount allow the servo lead to pass through.

Place the servo between the mounting blocks and space it from the hatch. Use a pencil to mark the mounting hole locations on the blocks.

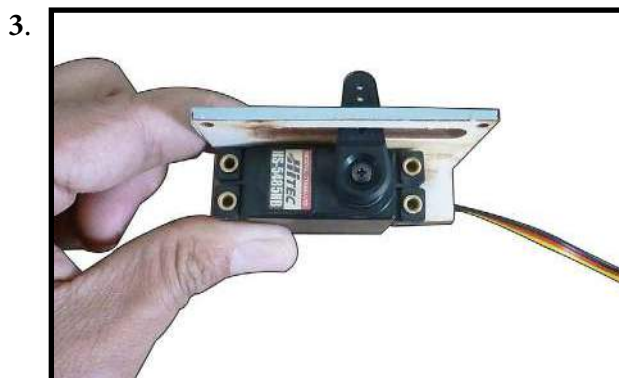

Use drill bit in a pin vise to drill the mounting holes in the blocks.

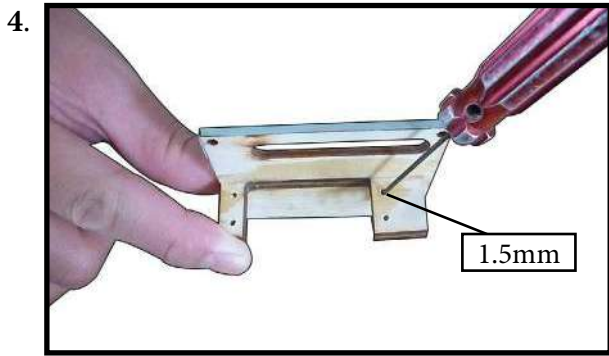

Apply 2-3 drops of thin C/A to each of the mounting holes. Allow the C/A to cure without using accelerator.

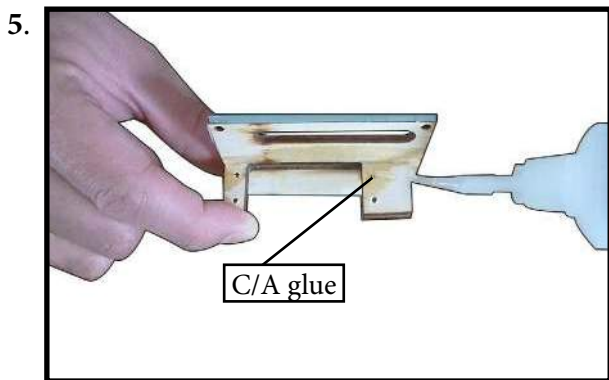

Use dental floss or heatshrunk tube to secure the connection so they cannot become unplugged.

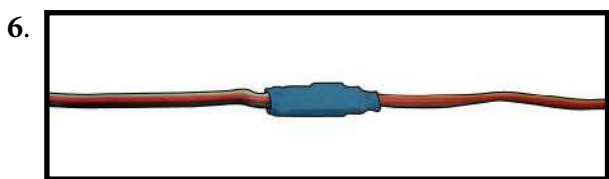

Secure the servo to the aileron hatch using Phillips screwdriver and the screws provided with the servo.

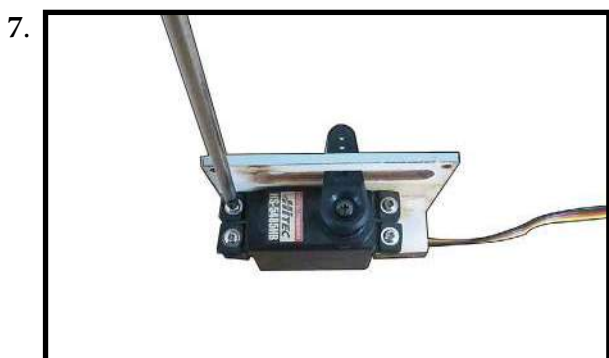

Apply 1-2 drops of thin C/A to each of the mounting tabs. Allow the C/A to cure without using accelerator.

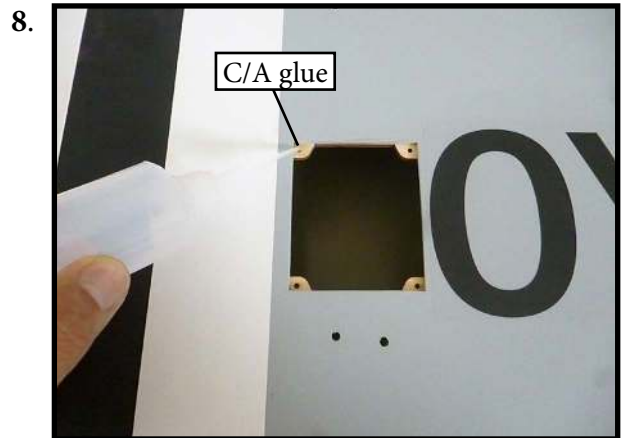

Remove the string from the wing at the servo location and use the tape to attach it to the servo extension lead. Pull the lead through the wing and remove the string.

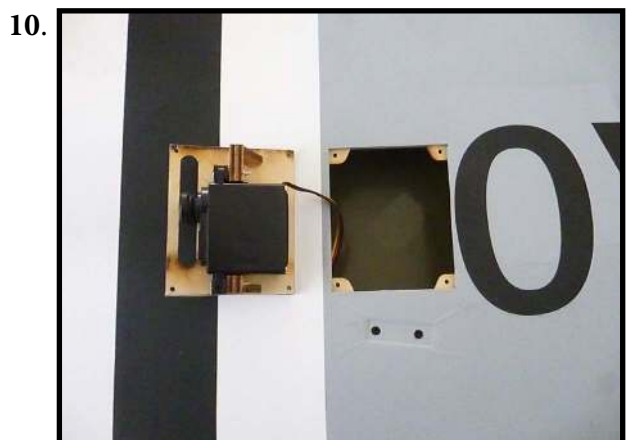
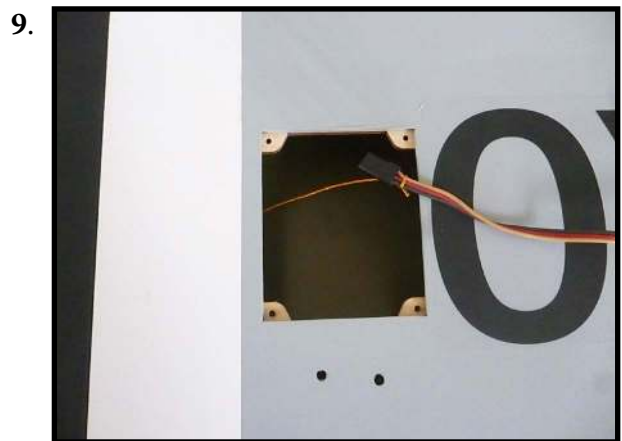

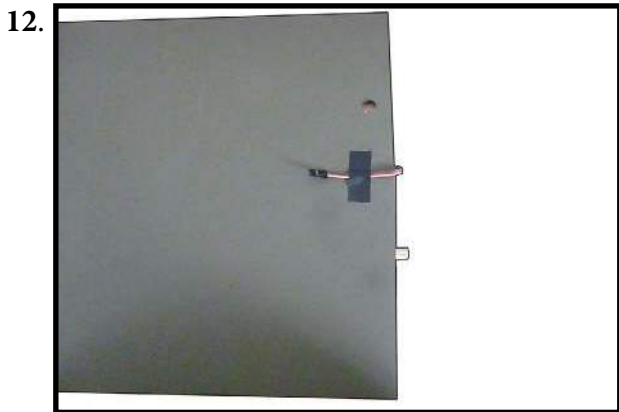

Set the aileron hatch in place and use a Phillips screw driver to install it with four wood screws.

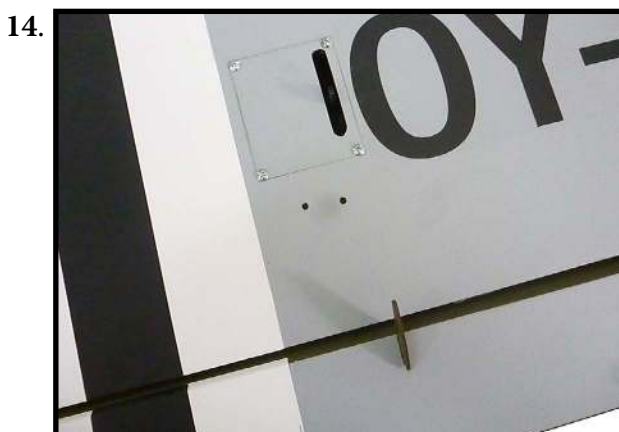
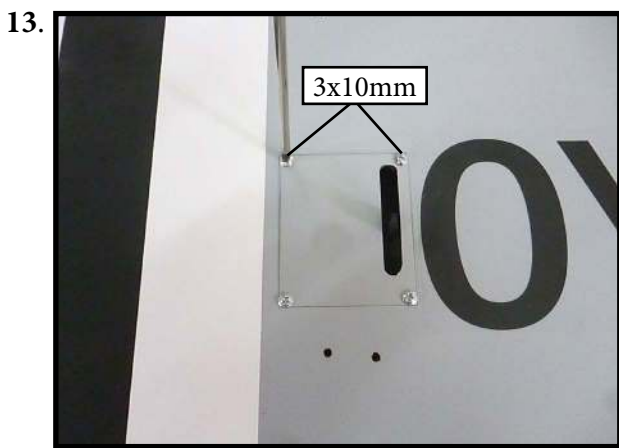

AILERON PUSHROD INSTALLATION

Please see below pictures.

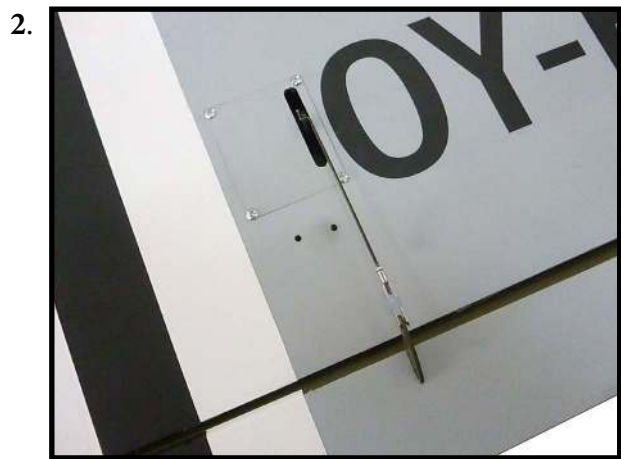
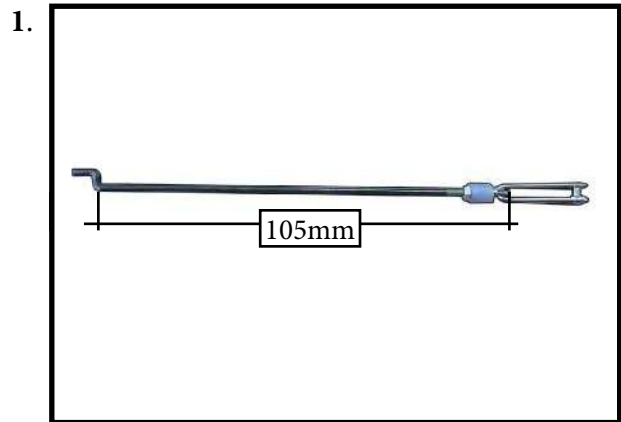

INSTALLING THE FUSELAGE SERVOS

 Because the size of servos differ, you may need to adjust the size of the precut opening in the mount. The notch in the sides of the mount allow the servo lead to pass through.

Install the rubber grommets and brass collets into all servos. Test fit the servos into the fuselage servo mounts.

Secure the servos with the screws provided with your radio system.

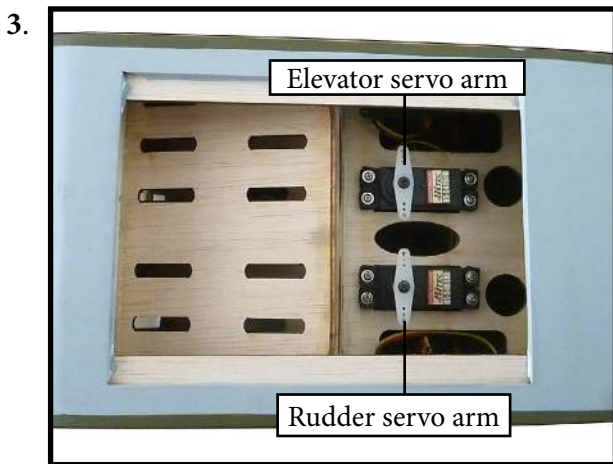
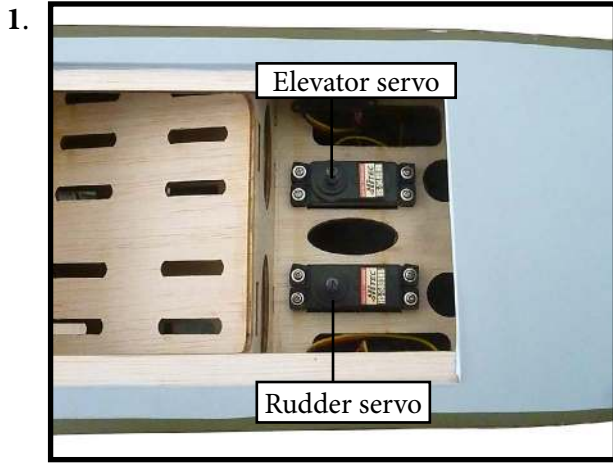

INSTALLING THE RECEIVER SWITCH

Install the switch into the precut hole in the side, in the fuselage.

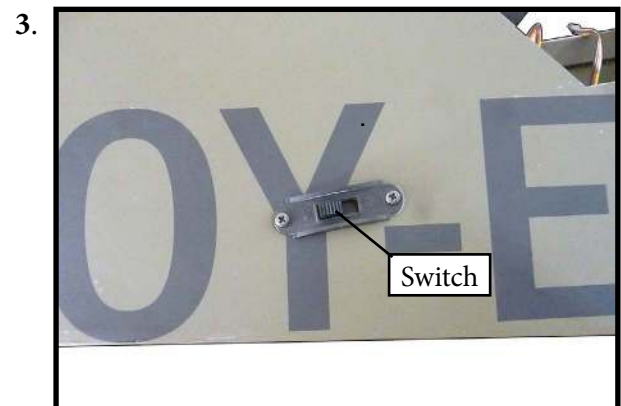
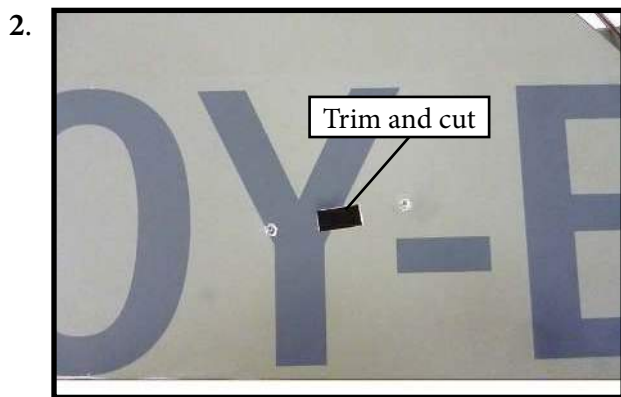
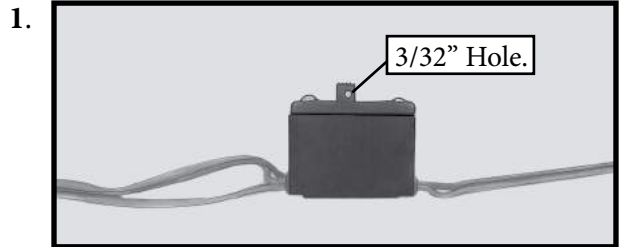

INSTALLING THE ENGINE SWITCH

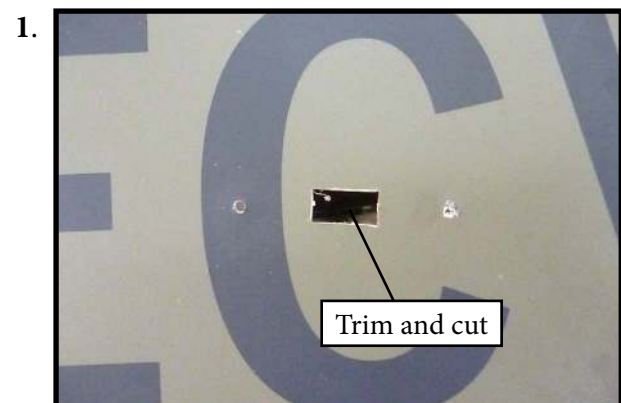

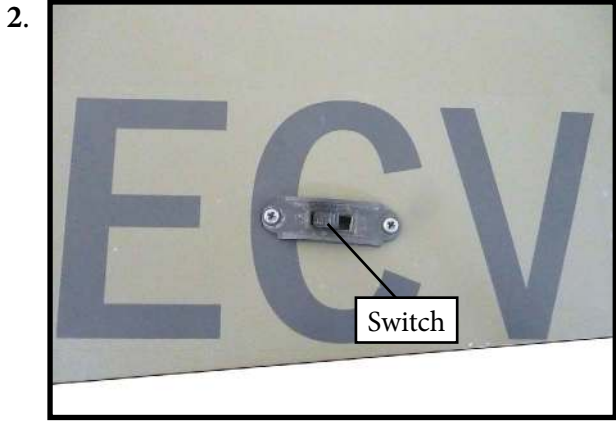

INSTALLING LANDING GEAR

Locate items necessary to install Sprin Landing Gear.

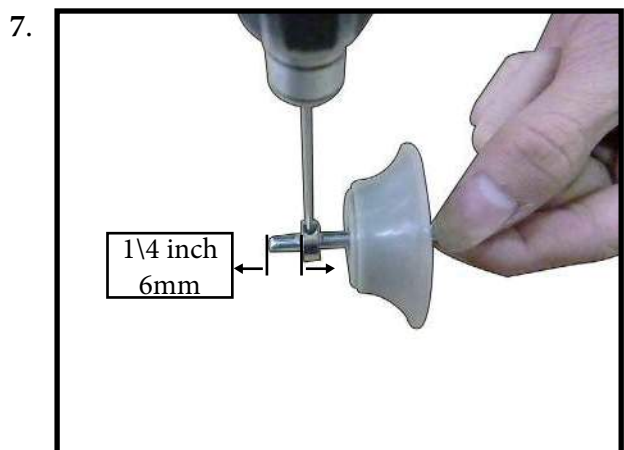
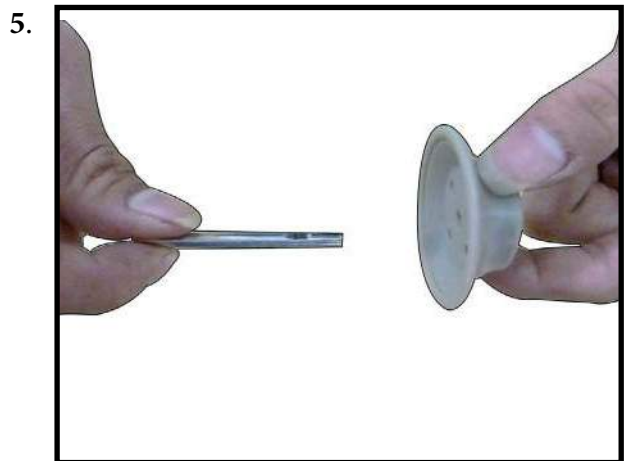
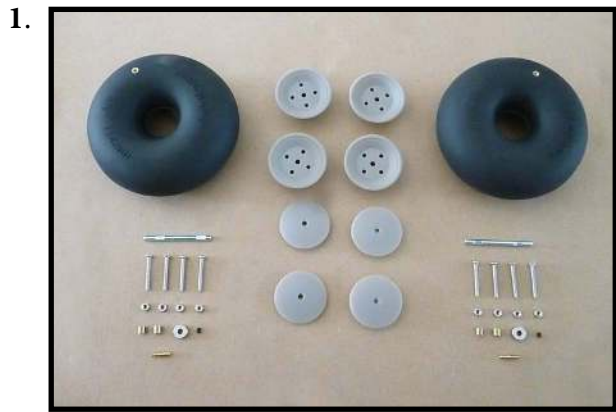

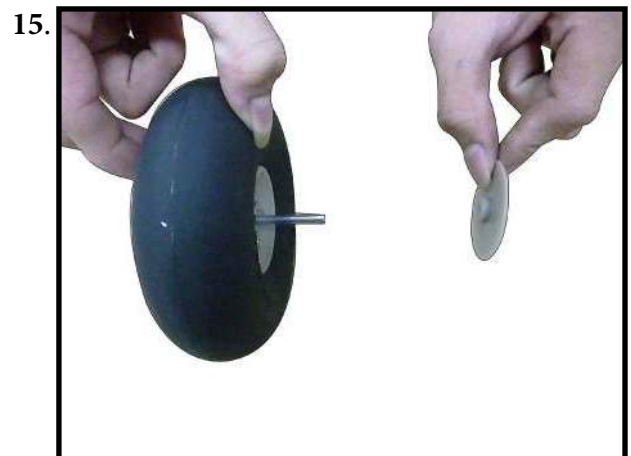
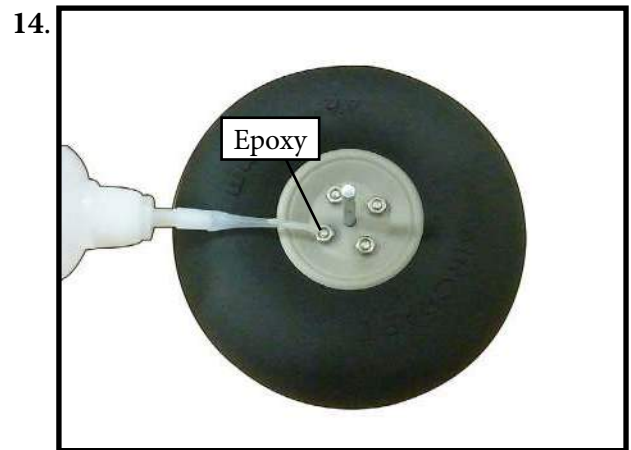
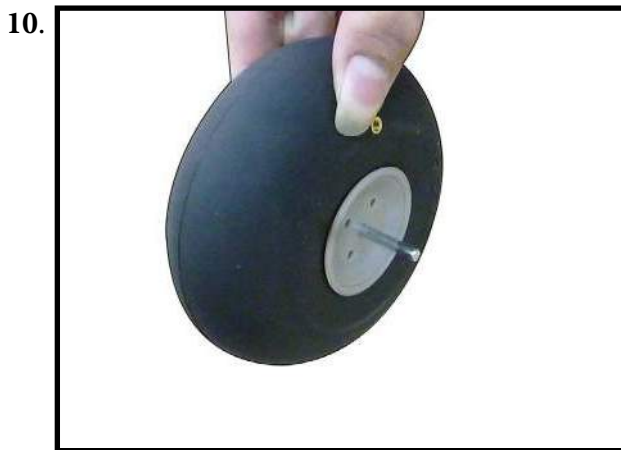
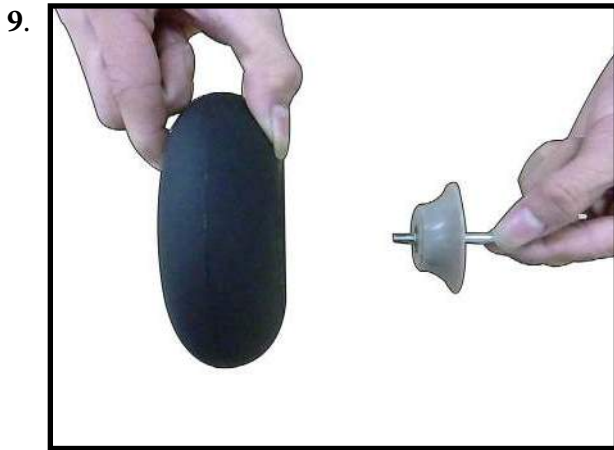
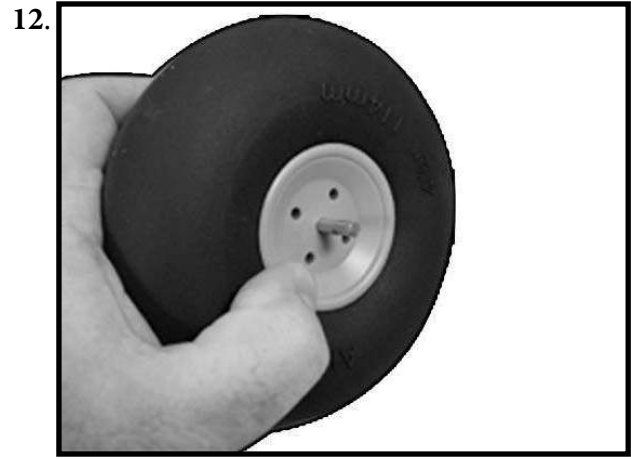
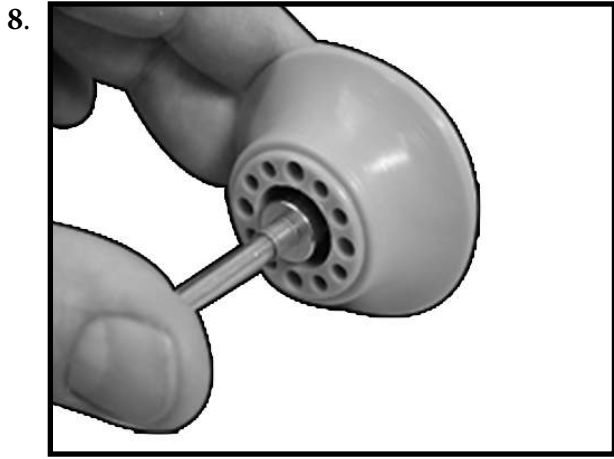

16.

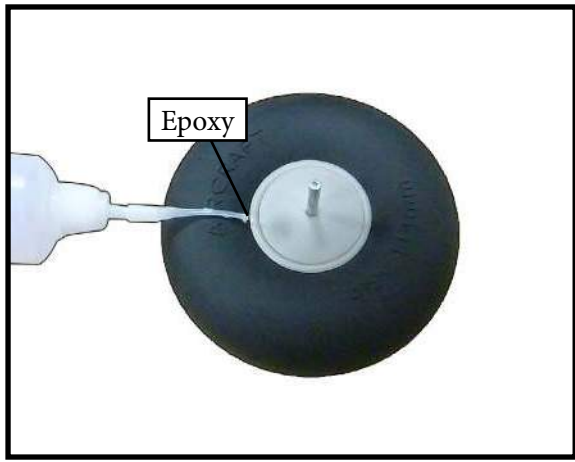

20.

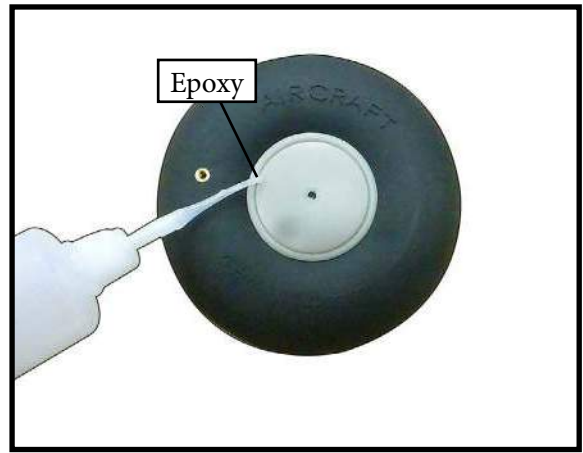

17.



21.

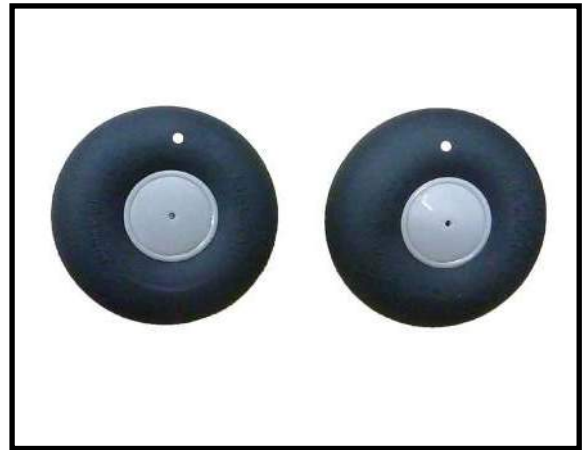

18.

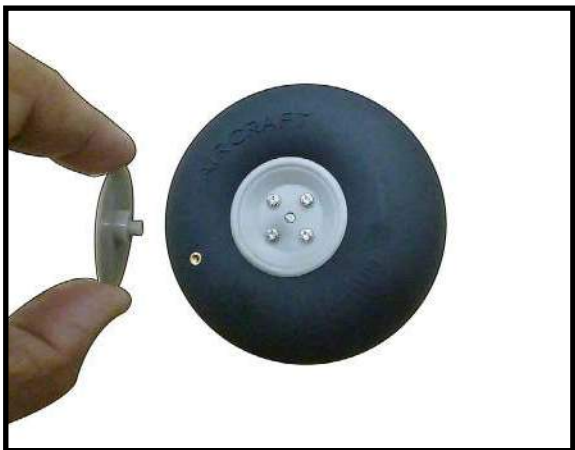

22.

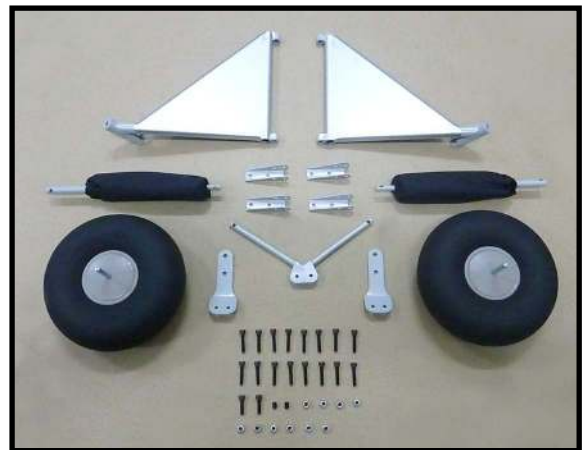

19.



23.

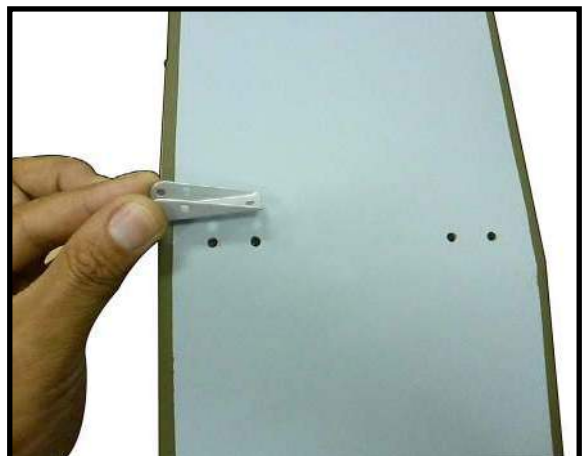

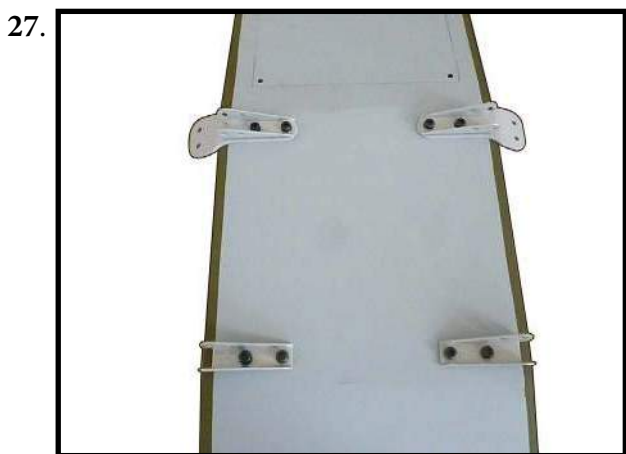
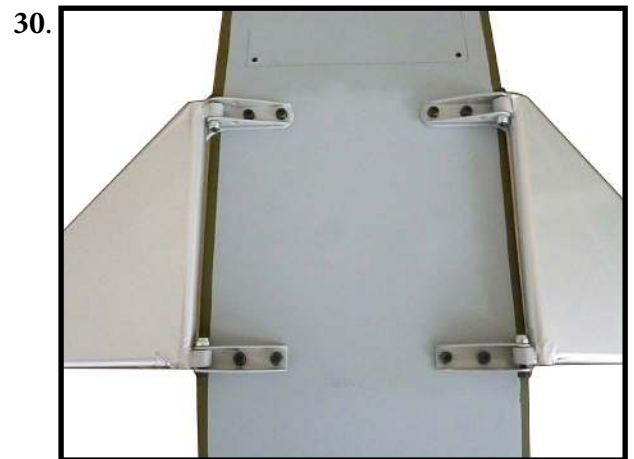
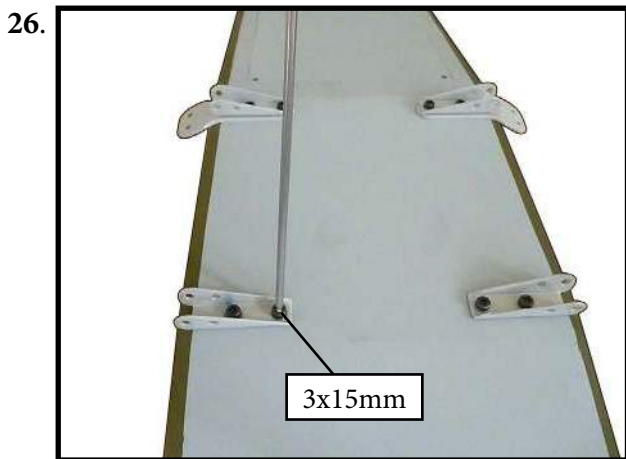
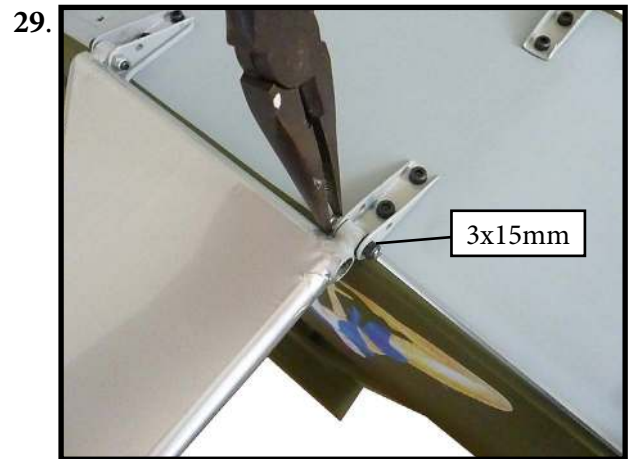
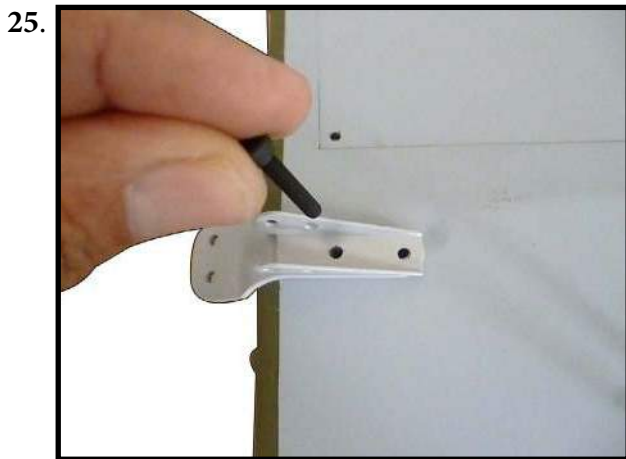
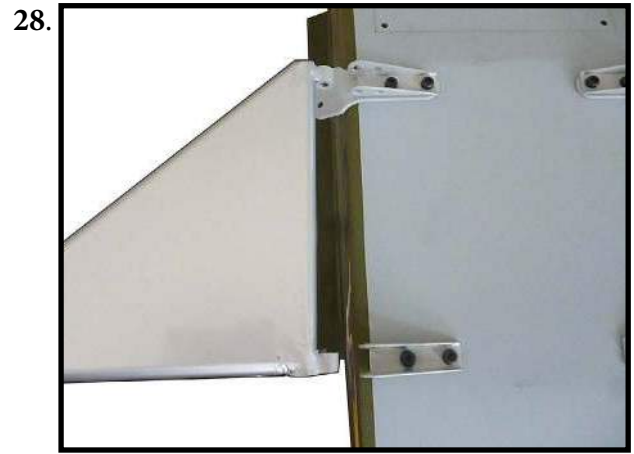
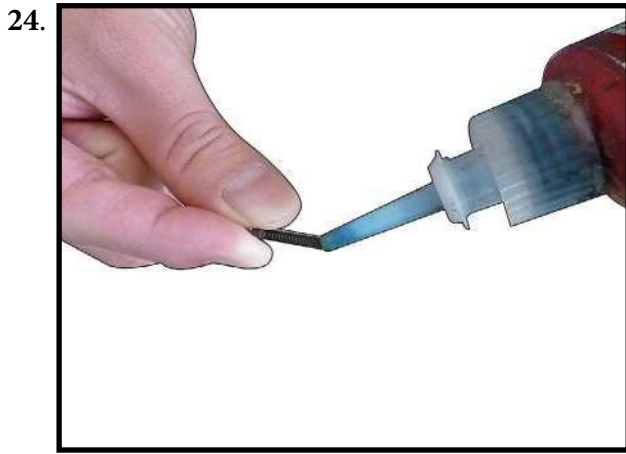

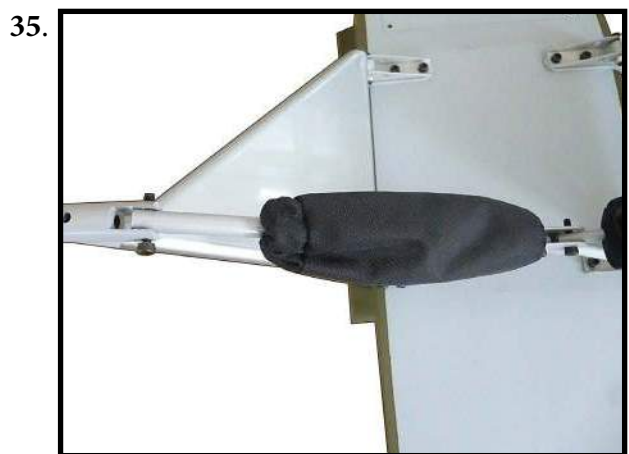
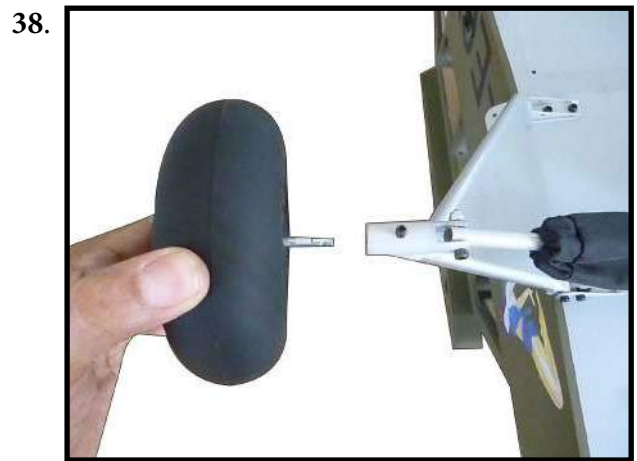
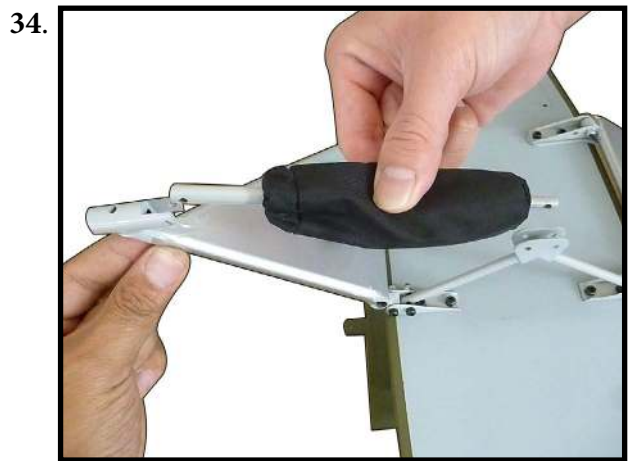
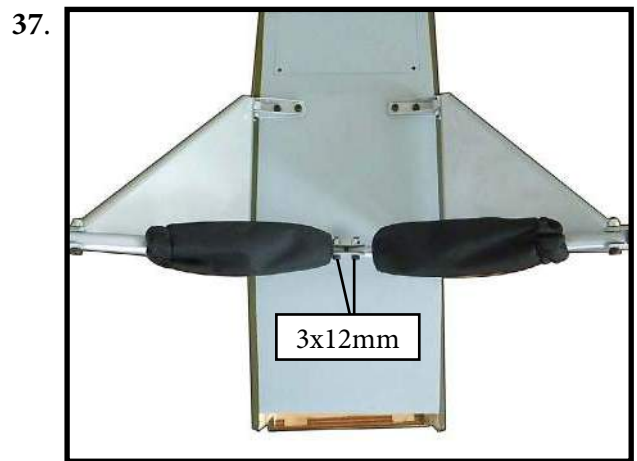
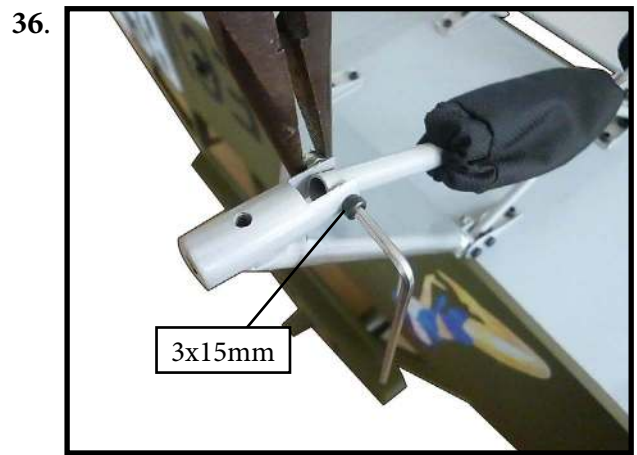
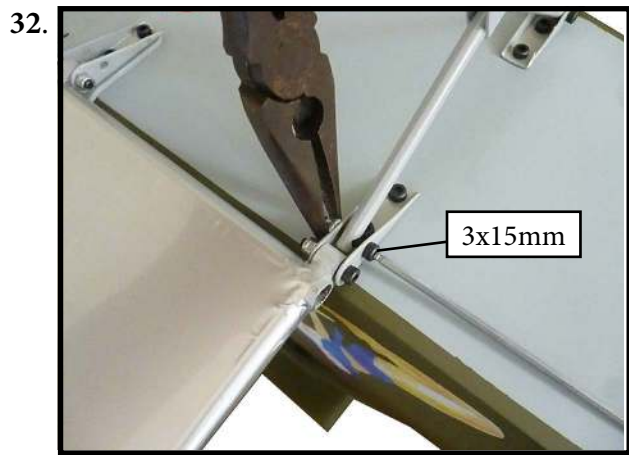

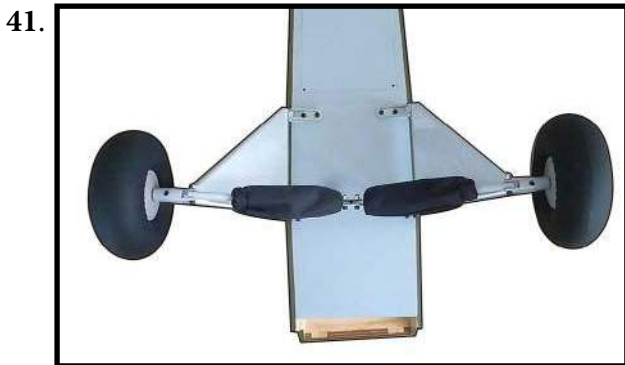
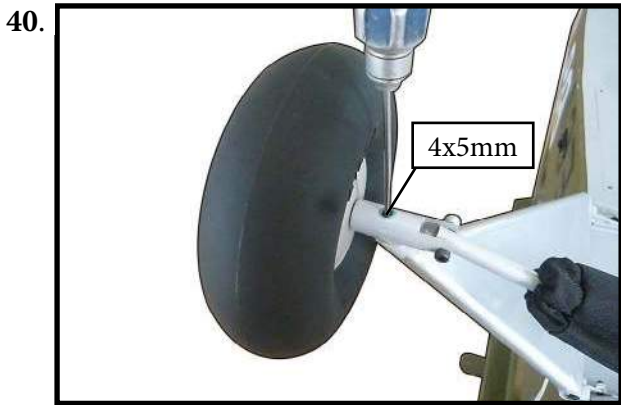

INSTALLING THE STOPPER ASSEMBLY

Using a modeling knife, carefully cut off the rear portion of one of the 3 nylon tubes leaving 1/2" protruding from the rear of the stopper. This will be the fuel pick up tube.

Using a modeling knife, cut one length of silicon fuel line. Connect one end of the line to the weighted fuel pick up and the other end to the nylon pick up tube.

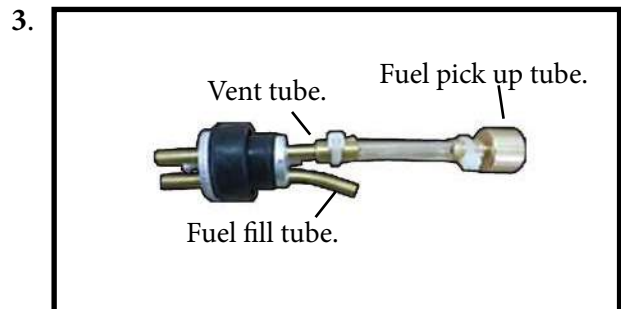
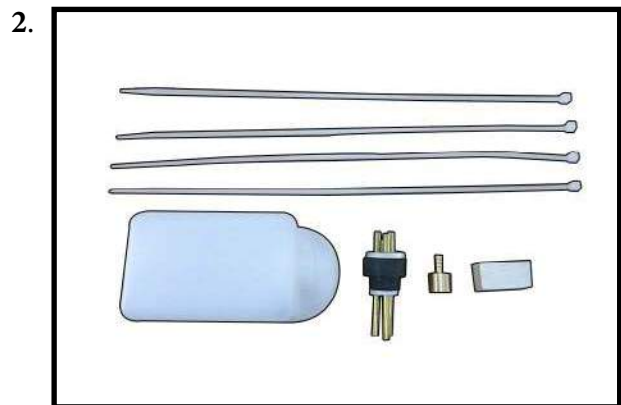
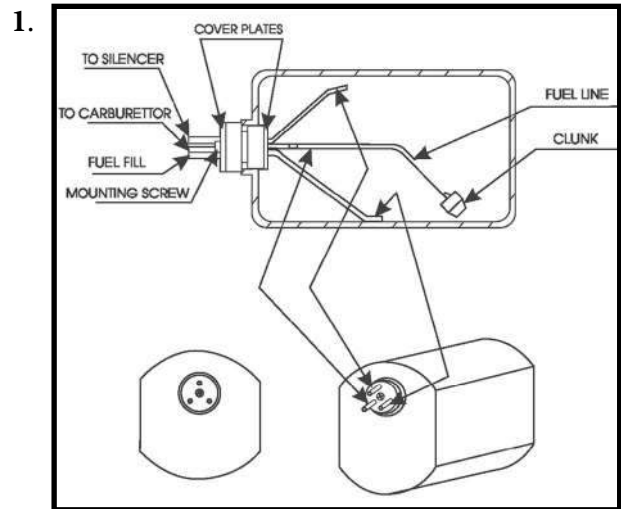

Carefully bend the second nylon tube up at a 45° angle. This tube is the vent tube.

Test fit the stopper assembly into the tank. It may be necessary to remove some of the flashing around the tank opening using a modeling knife. If flashing is present, make sure none falls into the tank.

With the stopper assembly in place, the weighted pick-up should rest away from the rear of the tank and move freely inside the tank. The top of the vent tube should rest just below the top of the tank. It should not touch the top of the tank.

When satisfied with the alignment of the stopper assembly tighten the 3x20mm machine screw until the rubber stopper expands and seals the tank opening. Do not overtighten the assembly as this could cause the tank to split.

FUEL TANK INSTALLATION

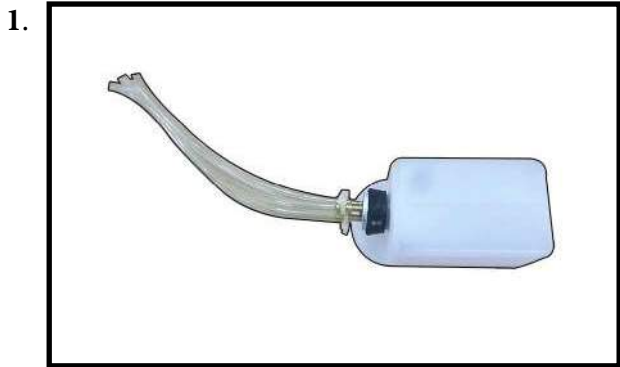

! *You should mark which tube is the vent and which is the fuel pickup when you attach fuel tubing to the tubes in the stopper. Once the tank is installed inside the fuselage, it may be difficult to determine which is which.*

Use balsa block to hold in place the fuel tank with C/A glue to secure the fuel tank.

Use balsa block to hold in place the fuel tank with C/A glue to secure the fuel tank inside the fuselage.

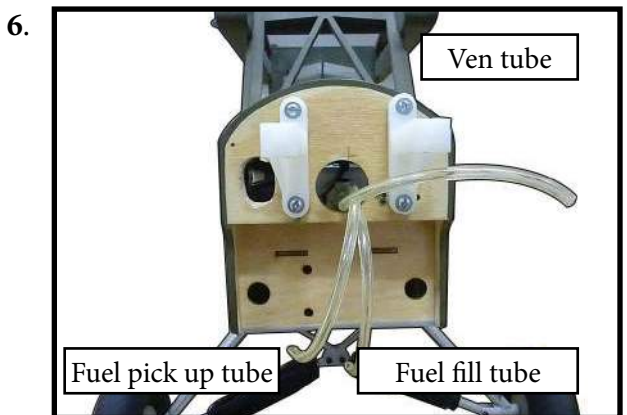

Connect the lines from the tank to the engine and muffler. The vent line will connect to the muffler and the line from the clunk to the carburetor.

ENGINE MOUNT INSTALLATION

Locate the items necessary to install the engine mount included with your model.

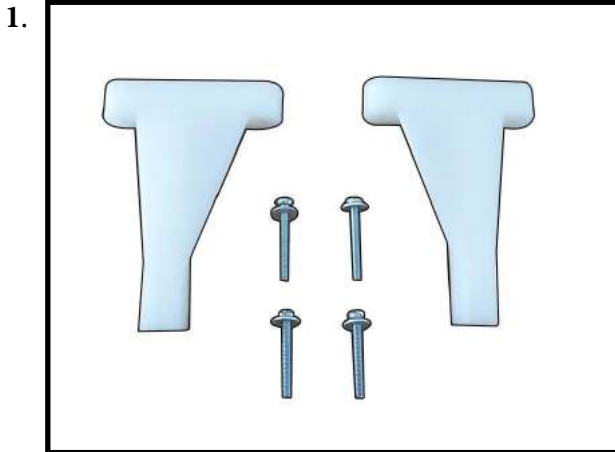

Use four 4x30mm head bolts and four 4mm washers to attach the engine mount rails to the firewall. Tighten the screws. Make sure to use threadlock on the screws to help prevent them from vibrating loose.

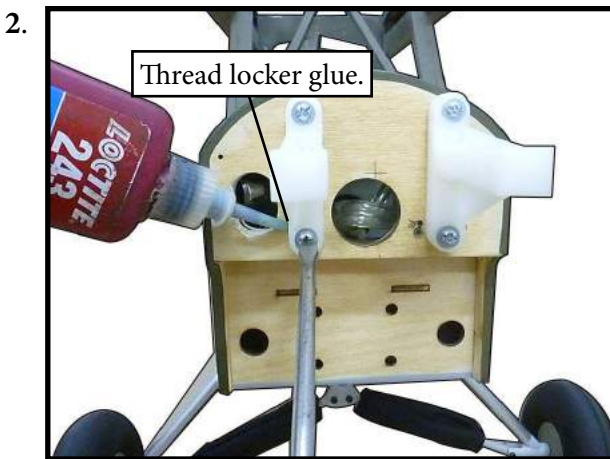

MOUNTING THE ENGINE

Position the engine with the drive washer (140mm) forward of the firewall as shown.

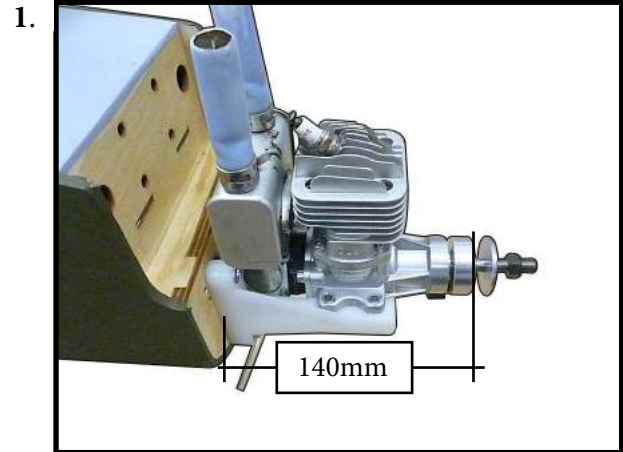

Use a pin drill and 4mm drill bit to drill a small indentation in the mount for the engine mounting screw.

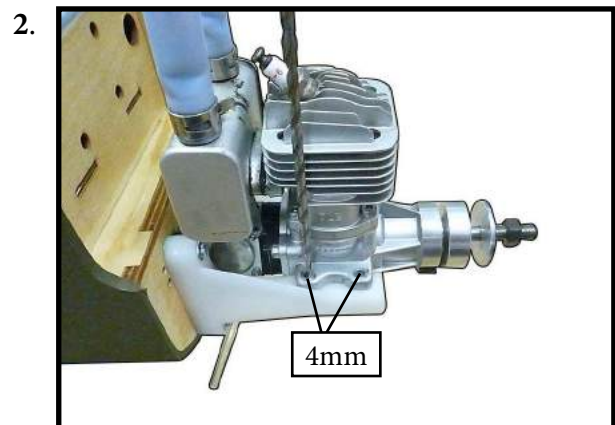

Use a drill to drill the four holes in the engine mount rails.

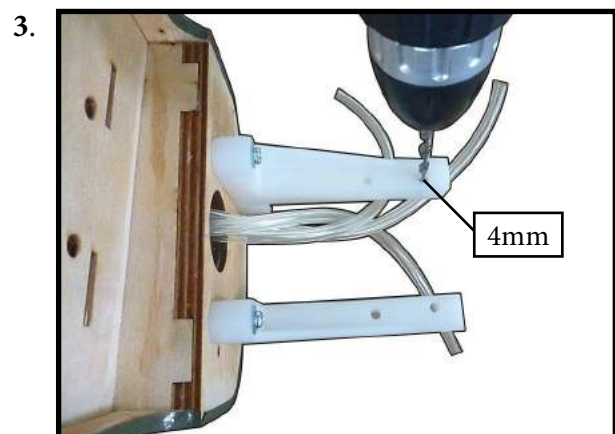

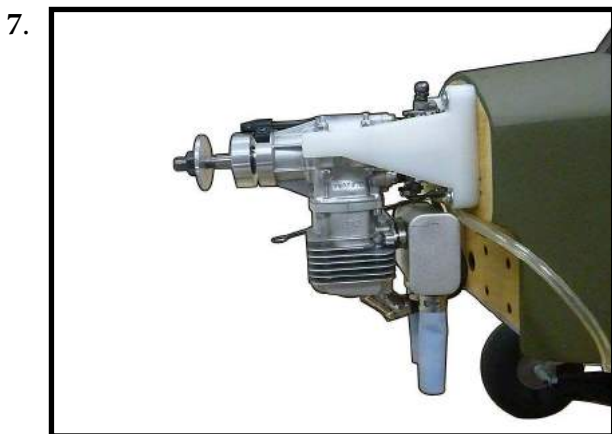
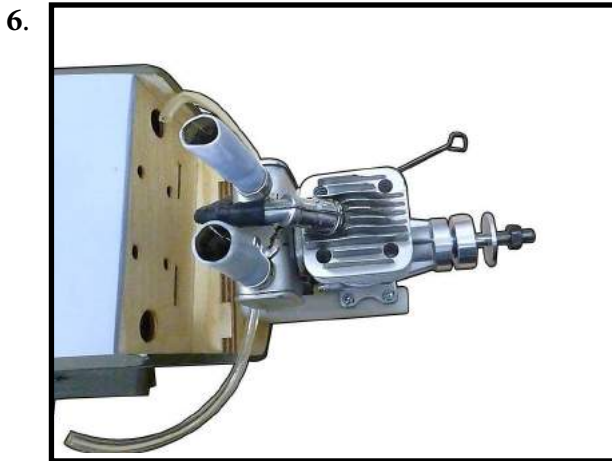
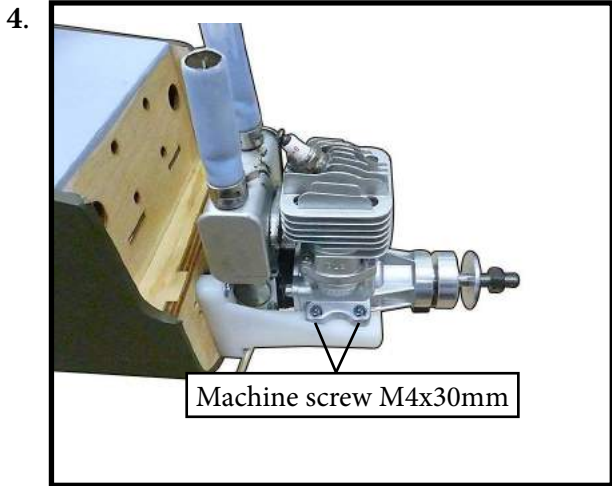

Reinstall the servo horn by sliding the connector over the pushrod wire. Center the throttle stick and trim and install the servo horn perpendicular to the servo center line.



Move the throttle stick to the closed position and move the carburetor to closed. Use a 2.5mm hex wrench to tighten the screw that secures the throttle pushrod wire. Make sure to use threadlock on the screw so it does not vibrate loose.



COWLING

Please see below pictures.



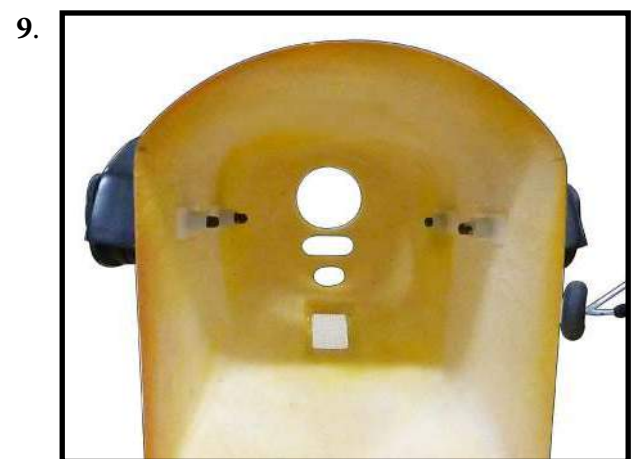
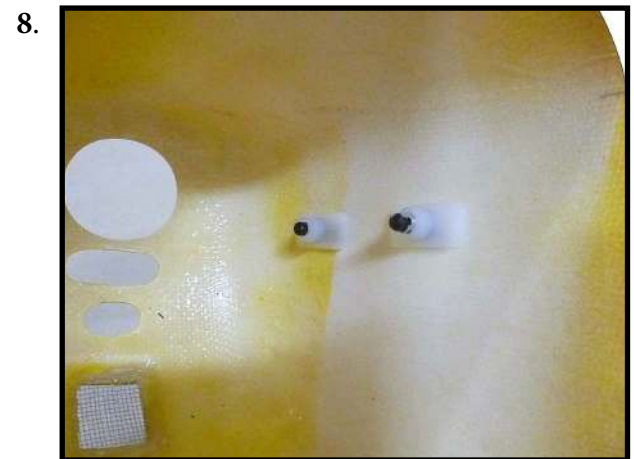
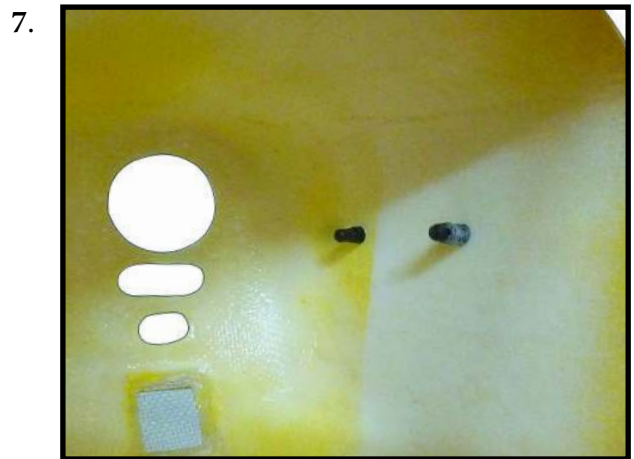
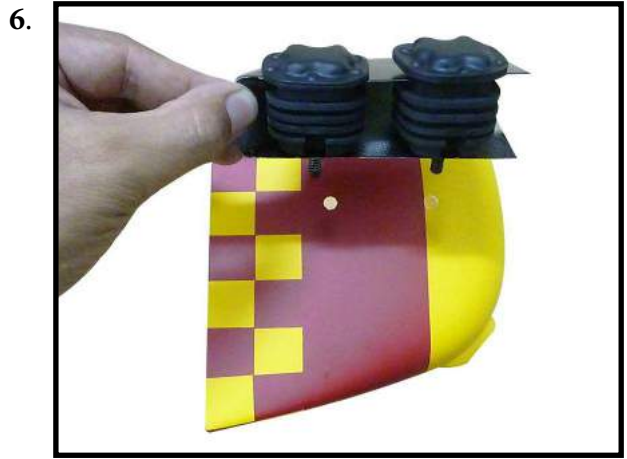

10.



14.

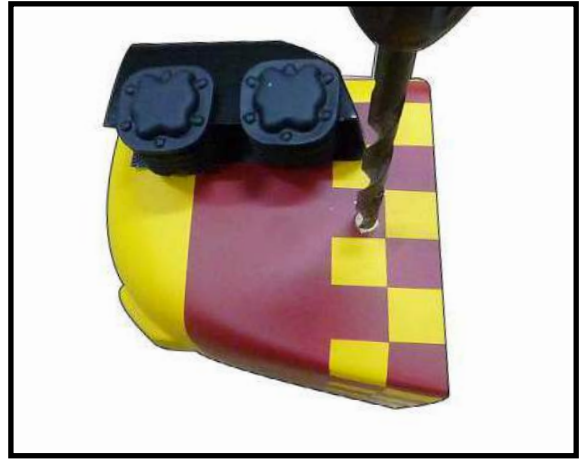

11.



15.



12.



16.



13.

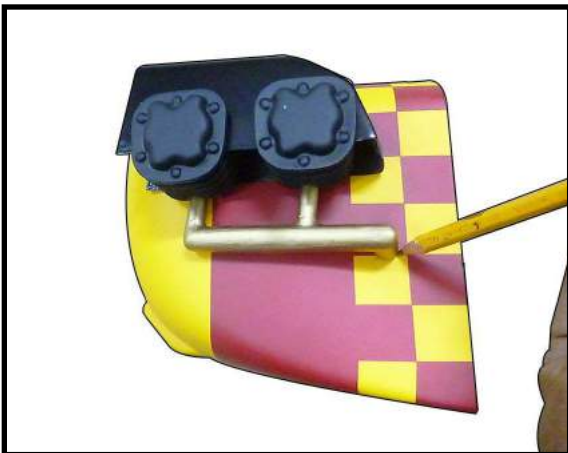

17.



18.

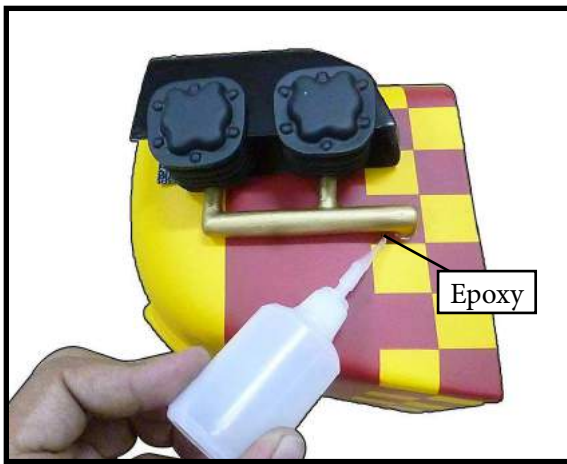

22.



19.



23.



20.

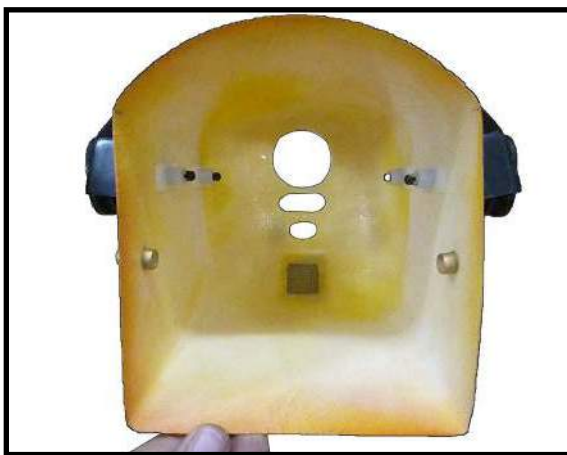

Tape the cowl to the fuselage using low-tack tape.

21.



24.



Use a drill and drill bit to drill the holes for the cowl mounting screws. Make sure the cowl position is correct before drilling each hole.

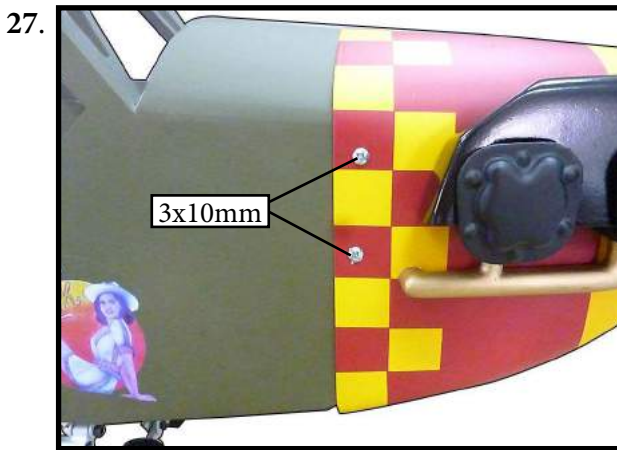
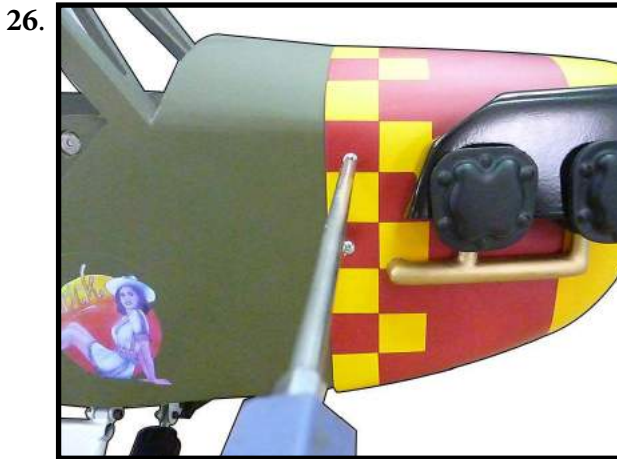
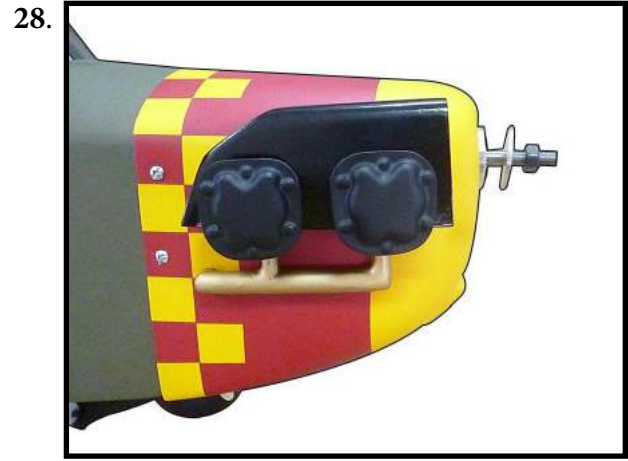
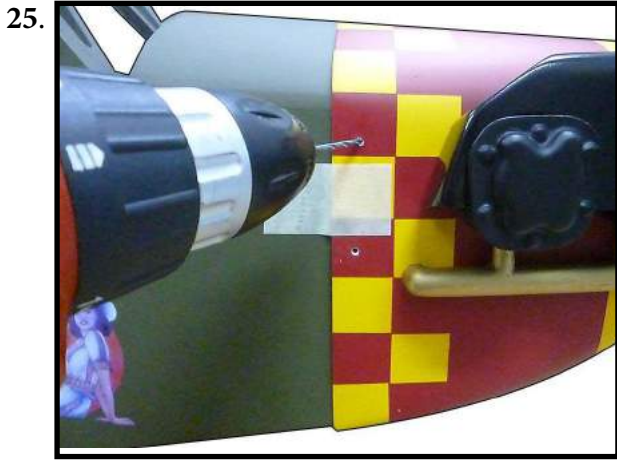

Because of the size of the cowl, it may be necessary to use a needle valve extension for the high speed needle valve. Make this out of sufficient length 1.5mm wire and install it into the end of the needle valve. Secure the wire in place by tightening the set screw in the side of the needle valve.



ELECTRIC POWER CONVERSION

Locate the items necessary to install the electric power conversion included with your model.



Recommend the items necessary to install the electric power conversion parts included with your model.

- **Motor: 110 - 2000 Watts**
- **Propeller: 17x8 ~ 19x10**
- **ESC: 85A**
- **6S- 8S Lipo**

Attach the electric motor box to the firewall suitable with the cross lines drawn on the electric motor box and firewall. Using epoxy and balsa stick to secure the motor box to the firewall. Please see pictures below.

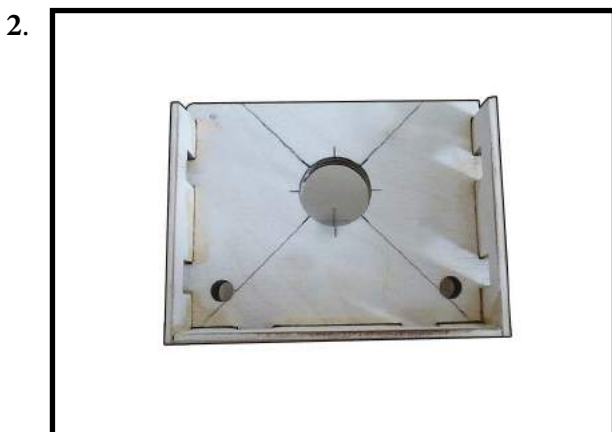

Attach the motor to the front of the electric motor box using four 4mm blind nut, four M4x25mm hex head bolts to secure the motor. Please see picture shown.

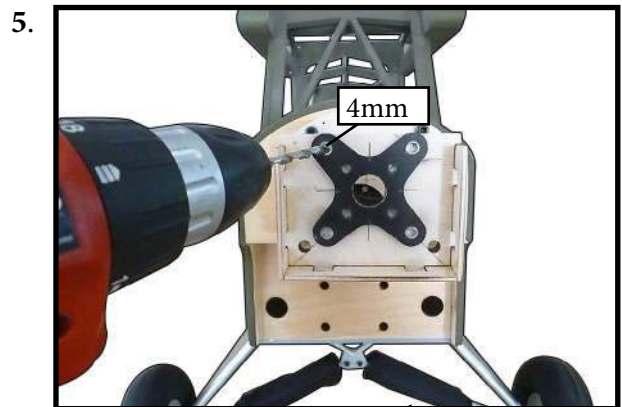

Then, use 5.5mm drill bit to enlarge the holes on the electric motor box.

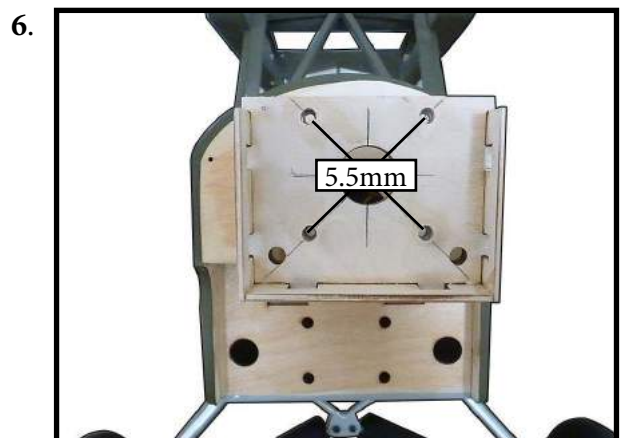

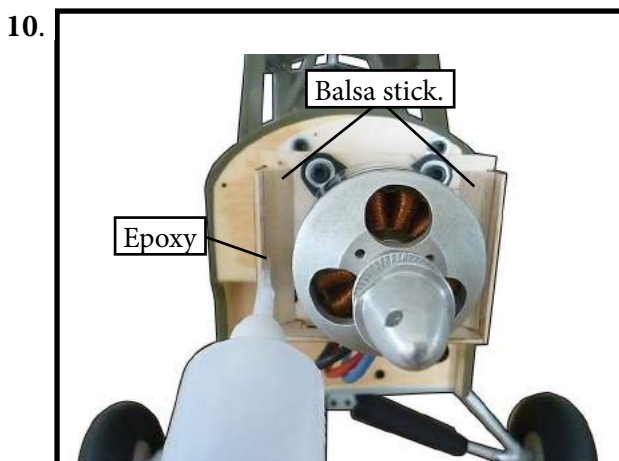
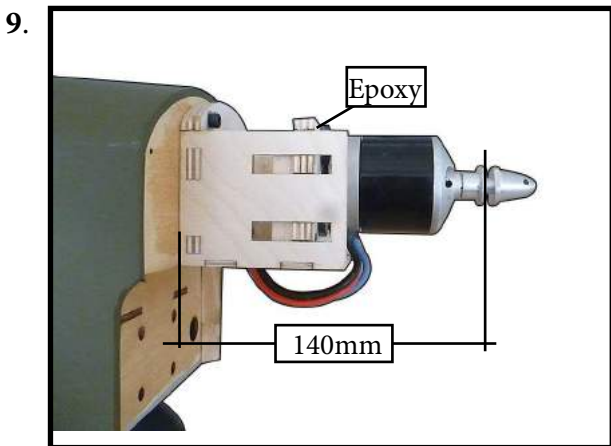
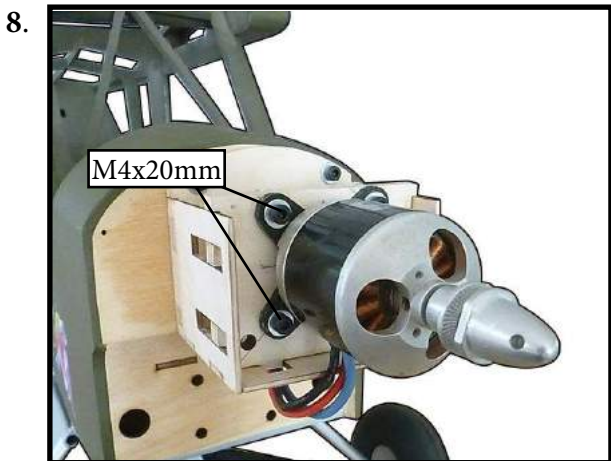
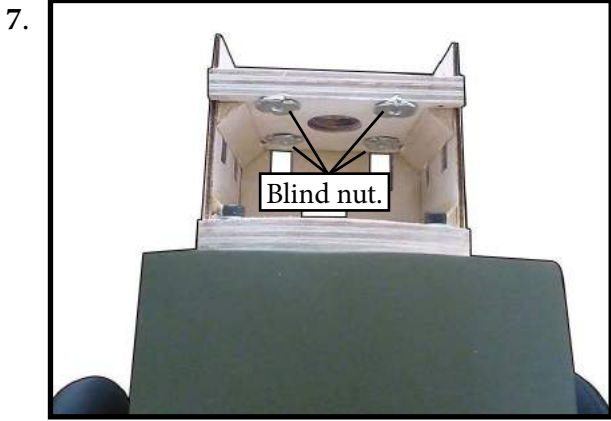

Attach the speed control to the side of the motor box using two-sided tape and tie wraps. Connect the appropriate leads from the speed control to the motor. Make sure the leads will not interfere with the operation of the motor.

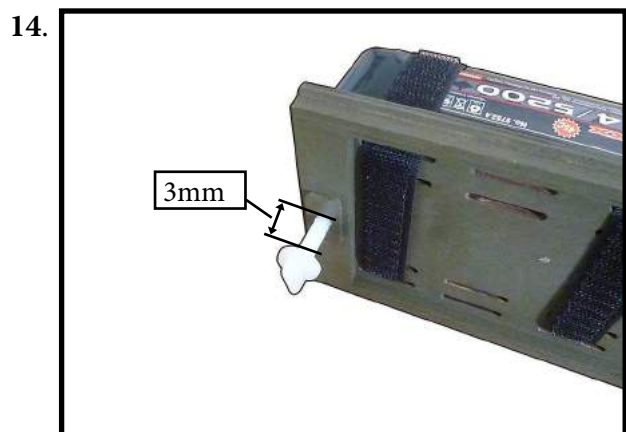
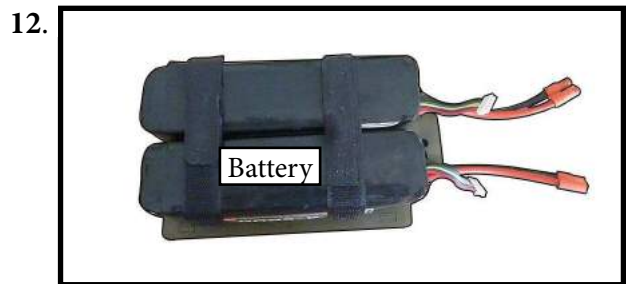
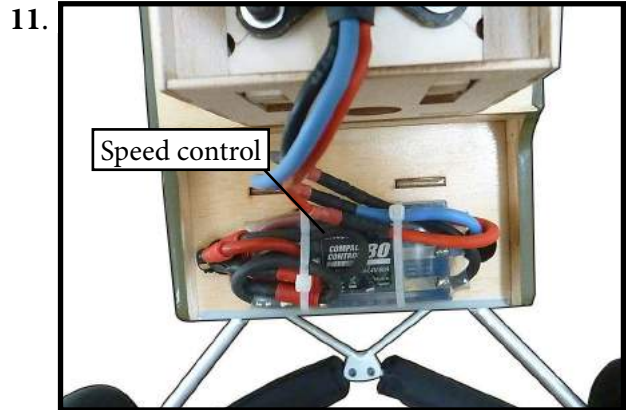



INSTALLING THE SPINNER

Install the spinner backplate, propeller and spinner cone.



 The propeller should not touch any part of the spinner cone. If it does, use a sharp modeling knife and carefully trim away the spinner cone where the propeller comes in contact with it.



ELEVATOR AND STABILIZER INSTALLATION

Slide the stabilizer into the slot in the fuselage. Center the stabilizer.

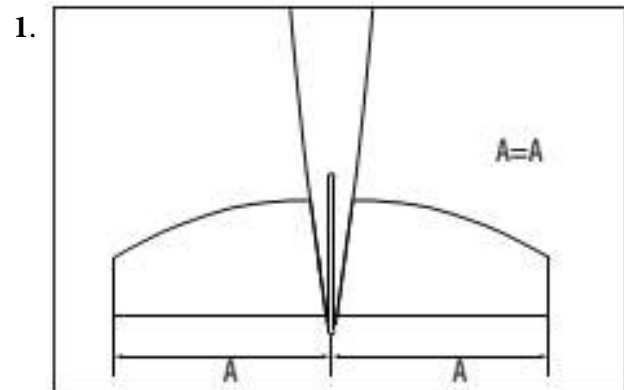

Measure from the tip of the stabilizer to the wing. Position the stabilizer so both measurements are equal. (Cowling has not been installed at this time.)

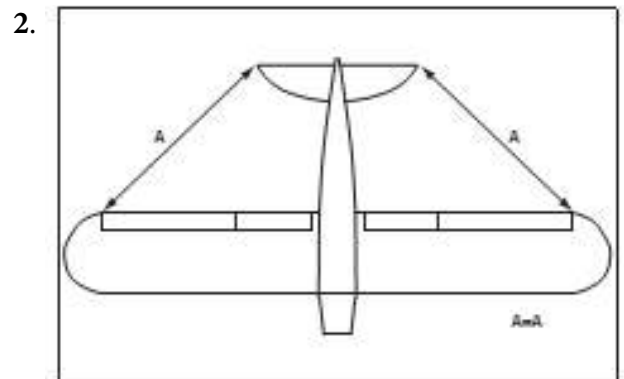

Check all alignments. Mark the outline of the fuselage on the top and bottom of the stabilizer.

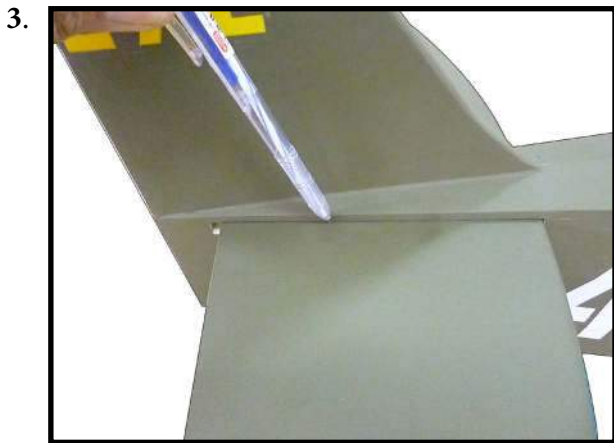

Use a ruler and carefully cut the covering 1/8 inch (3mm) inside the line drawn on the stabilizer to remove the covering from the center of the stabilizer. Remove the top and bottom covering. Use care not to cut into the underlying wood, weakening the stabilizer.

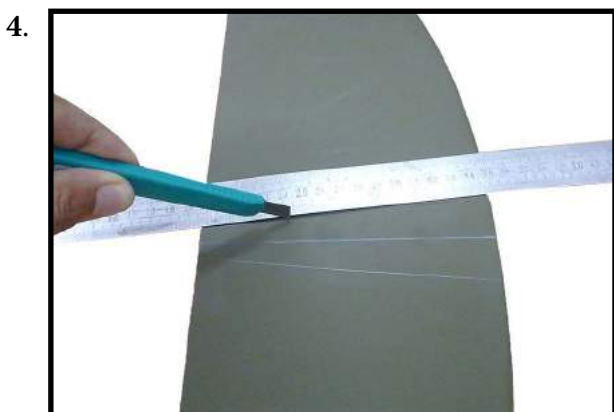

Lightly sand the elevator joiner wire where it contacts the elevators. Use a paper towel and isopropyl alcohol to remove any oil or debris from the joiner.

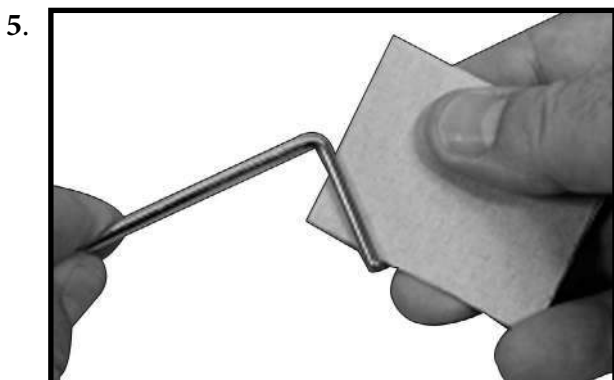

Fit the joiner wire into the elevator halves.

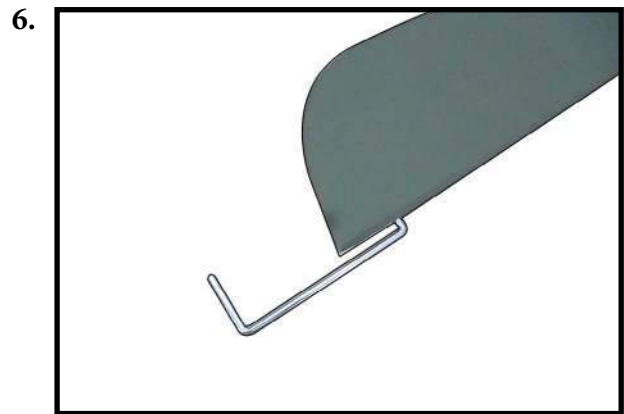

The elevator joiner wire must be flush with the leading edge of the elevator as shown.

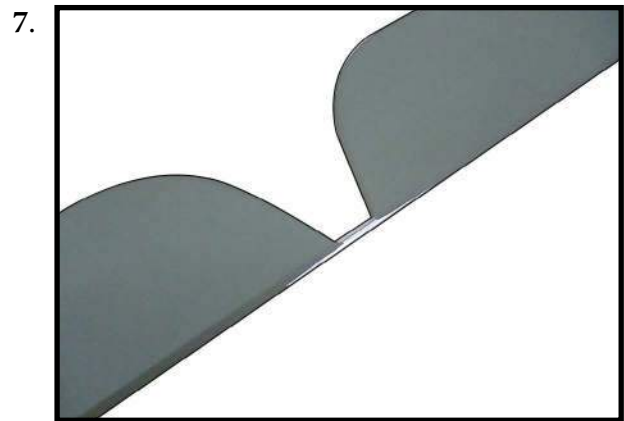

Continue the assembly of your model once joiner wire has been correctly checked and adjusted.

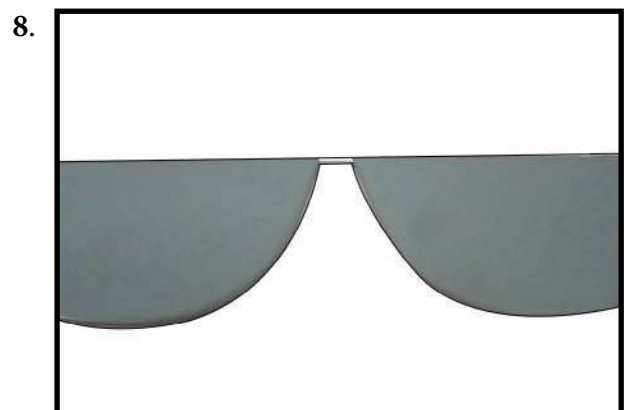

Remove the elevators from the joiner wire. Fit the joiner wire into the fuselage, noting the position from the previous step. This will guarantee the joiner is placed correctly so the elevators will be oriented as prepared in the previous step.

* The slot for the elevator horn will be located on the bottom right of the fuselage when the elevators are installed.

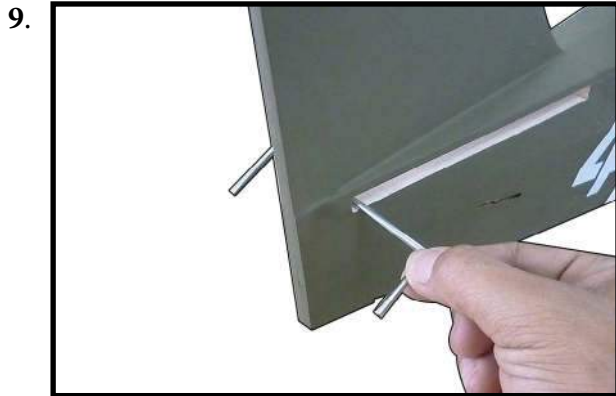

Slide the stabilizer partially into the fuselage so the wood at the center is exposed. Mix 1/2 ounce (15ml) of 30-minute epoxy. Use an epoxy brush to apply the epoxy to the exposed wood on the top of the stabilizer.



Carefully turn the model over and apply epoxy to the exposed wood on the bottom of the stabilizer. Slide the stabilizer back into position.

* Use care not to get epoxy on the elevator joiner wire.

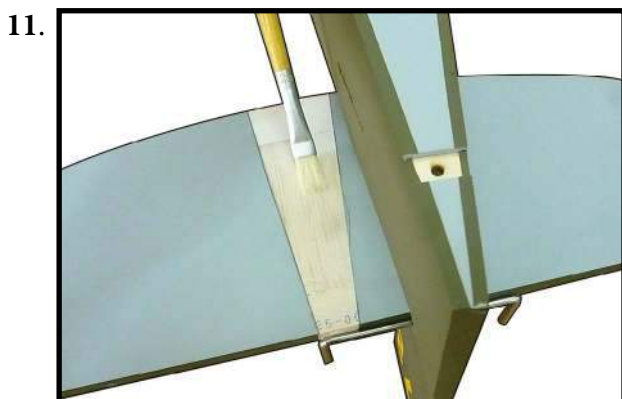

Once the alignment of the stabilizer has been verified, use a paper towel and isopropyl alcohol to remove any excess epoxy from the fuselage and stabilizer. Allow the epoxy to fully cure before proceeding.

* If you find epoxy on the joiner wire, use the paper towel and isopropyl alcohol to clean the joiner.

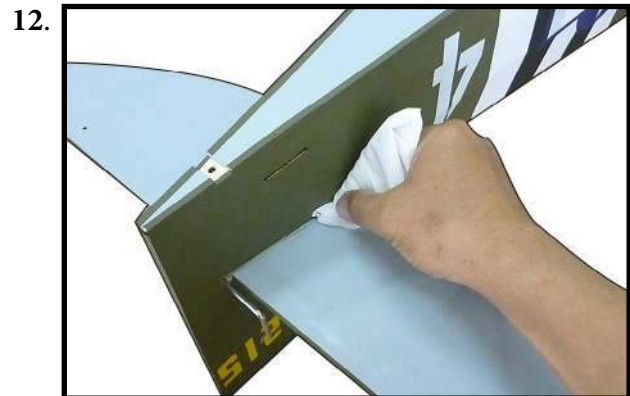

Use a pin vise and 1/16-inch (1.5mm) drill bit to drill a hole in the center of each hinge slot to allow the CA to wick into the hinge. Drill holes in both the elevators and stabilizer surfaces at this time. Place a T-pin in the center of each hinge along side the slot in the hinge. This will help center the hinge when it is placed in the elevators. Slide the hinges into position with the T-pin resting against the edge of the control surface.

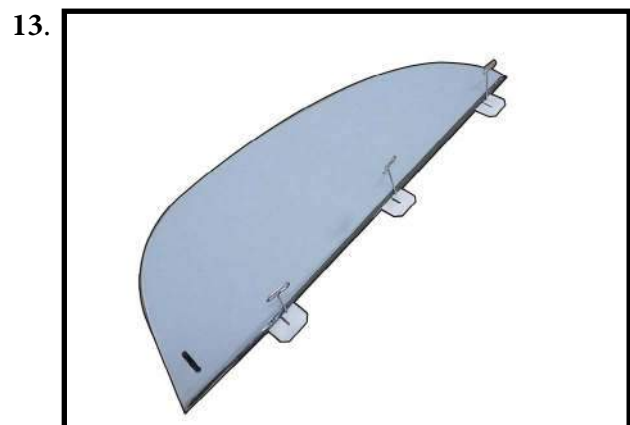

Fit the elevator into position on the stabilizer. Guide the joiner wire and hinges into position.

14.



Fit the elevator so the leading edge fits tightly against the trailing edge of the stabilizer.

15.

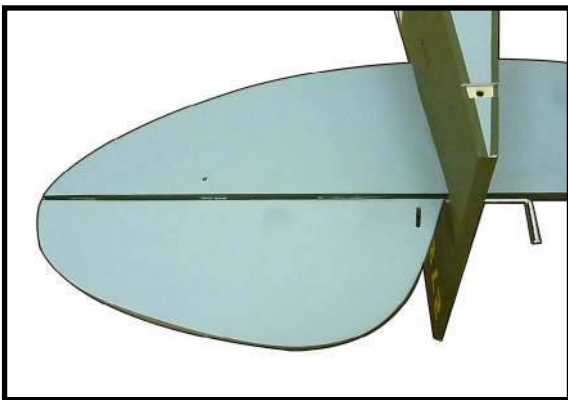

Check the fit of both elevators at this time. Once checked, remove the elevators.

16.

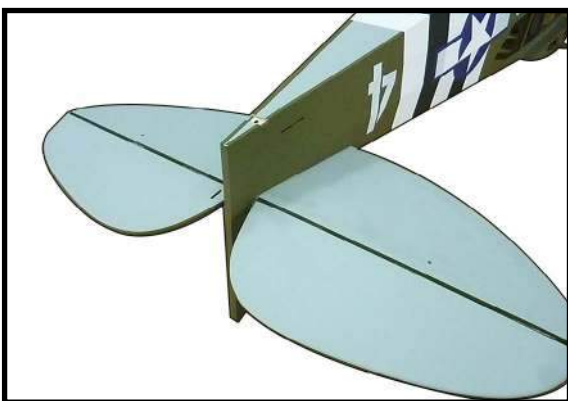

Use a small strip of the clear packing material and slide it between the joiner wire and stabilizer. Make sure the packing material is cut so it does not obstruct the hinge slot. Use a small piece of low-tack tape to hold the packing material in position.

The clear packing material is used to prevent accidentally gluing the elevator or joiner wire to the stabilizer.

17.

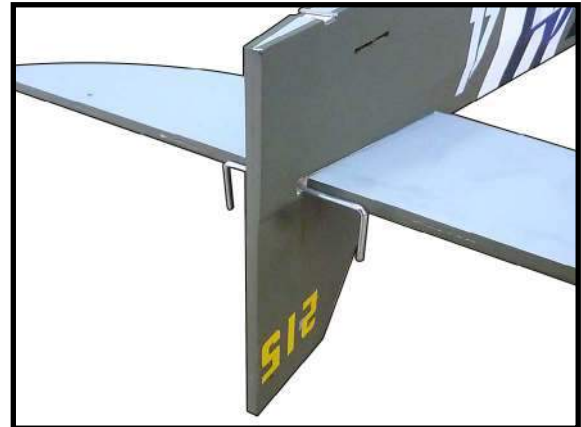

Mix a small amount of 15-minute epoxy. Use a toothpick to apply epoxy to the joiner wire.

18.

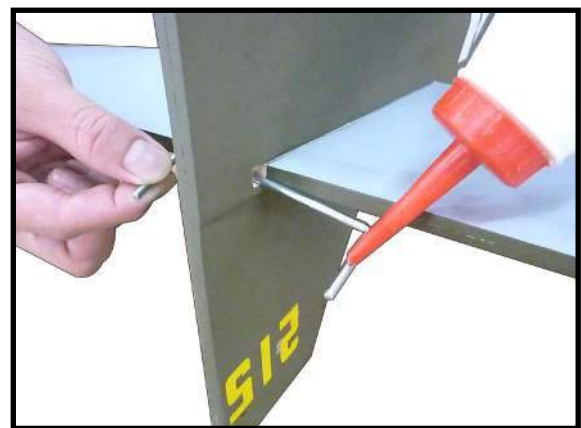

Use a toothpick to apply epoxy to the stabilizer where it contacts the joiner wire.

19.

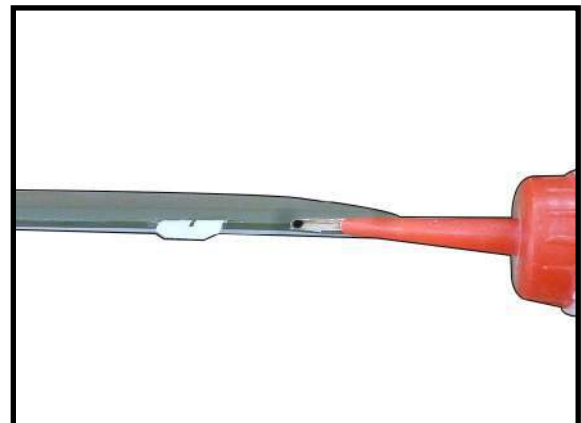

Fit the elevators back into position. Remove the T-pins and slide the elevators tightly against the stabilizer. Use a paper towel and isopropyl alcohol to remove any excess epoxy before it begins to cure.



Check the alignment of the elevators in relationship to the stabilizer at the tips. There should be enough gap between the balance tab and stabilizer to they can move freely.

* Do not use CA accelerator when gluing hinges. The CA must be allowed to soak into each hinge to provide the greatest bond between the hinges and surrounding wood

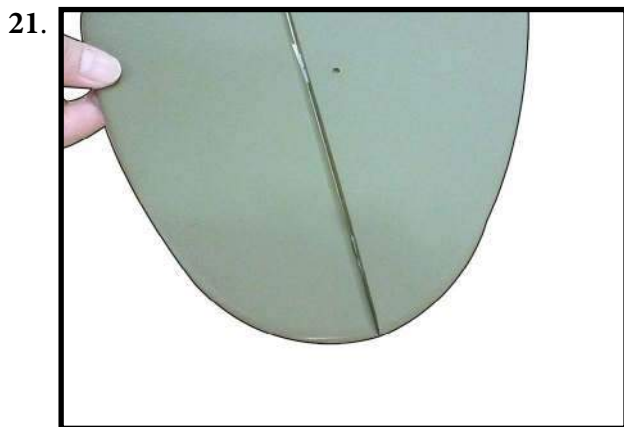

Flex the elevator slightly, making sure to keep the gap between the elevator and stabilizer as narrow as possible. Saturate each of the hinges using thin CA. Apply CA to the top of the hinges.

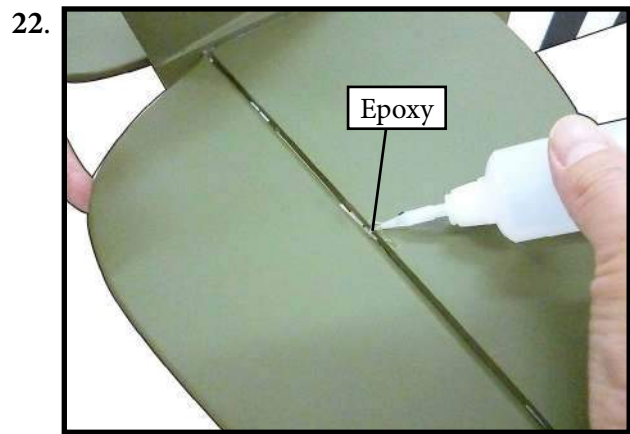

Flex the elevator slightly, making sure to keep the gap between the elevator and stabilizer as narrow as possible. Saturate each of the hinges using thin CA. Apply CA to the bottom of the hinges. Allow the CA to cure before proceeding.

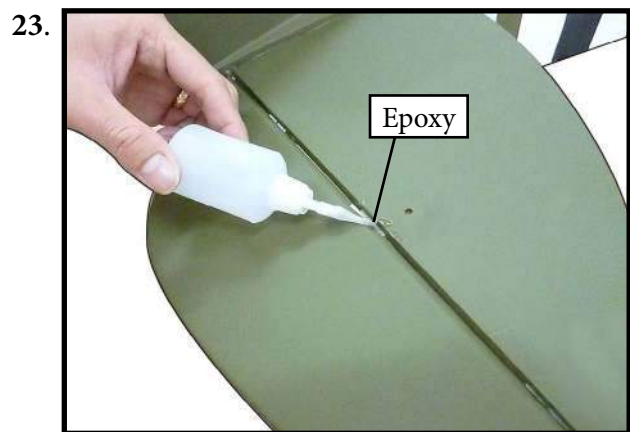

Gently pull on the fixed and moving surface to make sure the hinges are glued securely. If not, reapply thin CA to any hinges that are found loose.

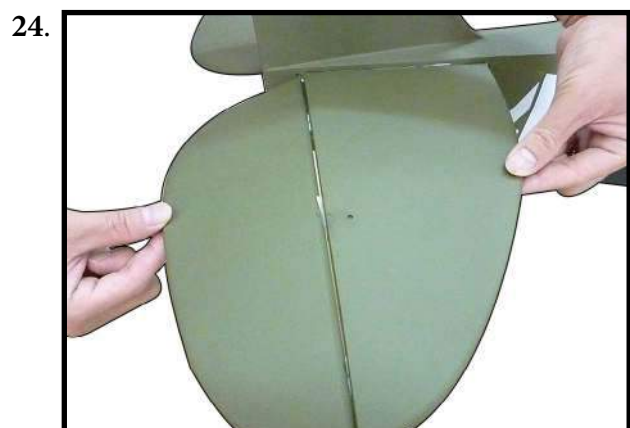

Flex the control surface through its range of motion a few times to break-in the hinges. This will reduce the initial-load on the servo when the surface is first actuated.

25.

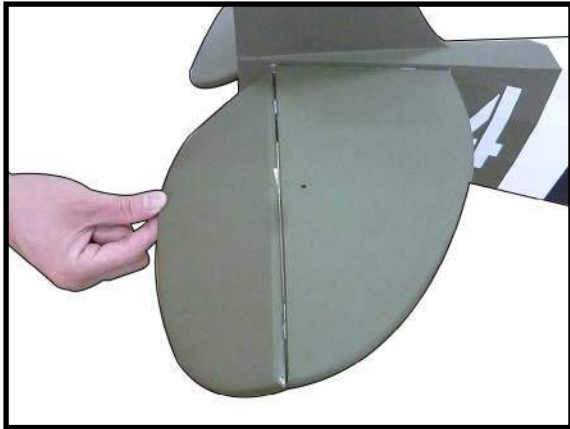

RUDDER INSTALLATION

Use a pin vise and 1/16-inch (1.5mm) drill bit to drill a hole in the center of each hinge slot. This allows the CA to wick into the hinge. Drill holes in both the rudder and fin surfaces at this time. Place a T-pin in the center of the hinge. Slide the hinges into position with the T-pin resting against the edge of the control surface.

1.

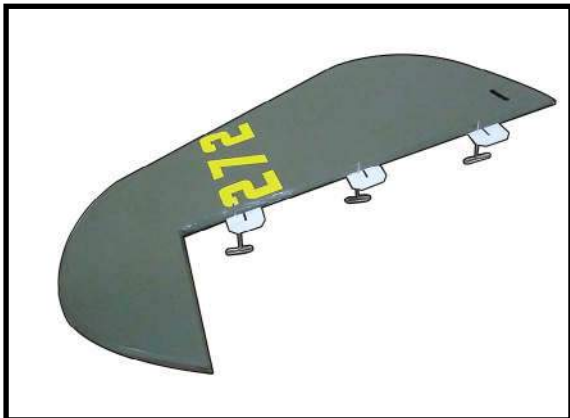

Check the fit of the rudder to the fuselage. Make sure the tail wheel wire fits into the rudder, and that the notch fits over the tail wheel bushing. There should be no gap between the fin and rudder.

2.



Once the epoxy fully cures, apply thin CA to both sides of each hinge. Once the CA cures, gently pull on the fixed surface and control surface to make sure the hinges are glued securely. If not, apply additional CA to secure each of the hinges.

3.



4.

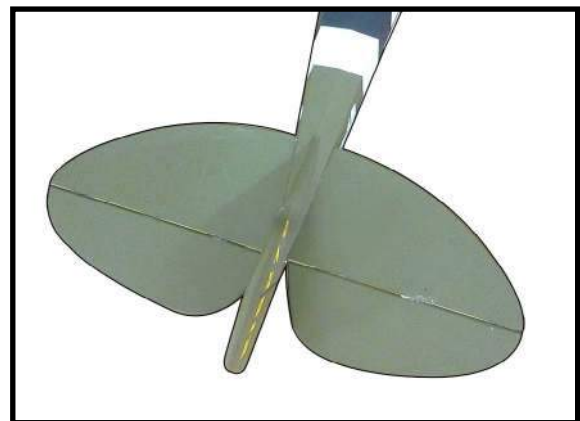

INSTALL RUDDER CONTROL HORN

Repeat steps to install the rudder control horn as same as steps done for ailerons.

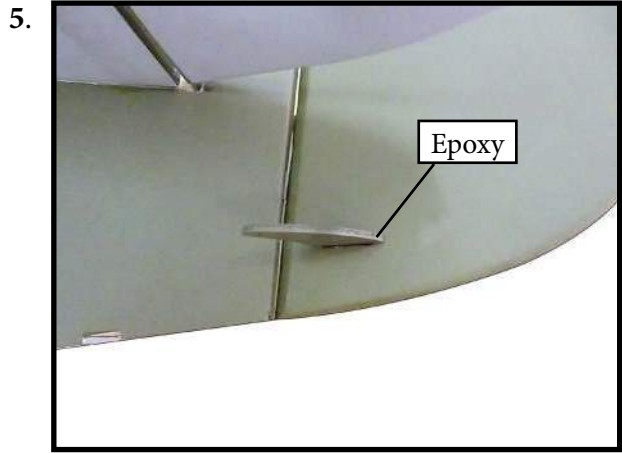
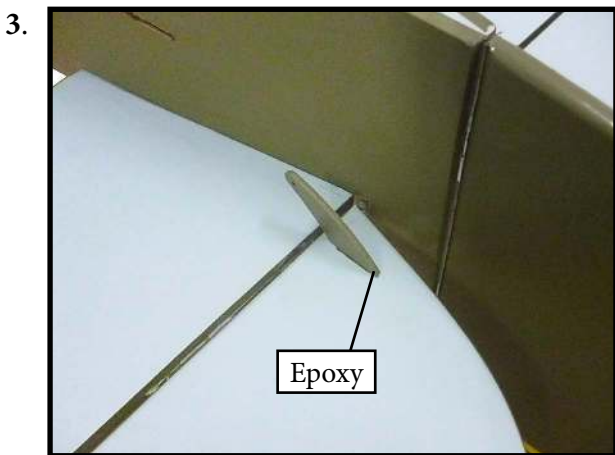
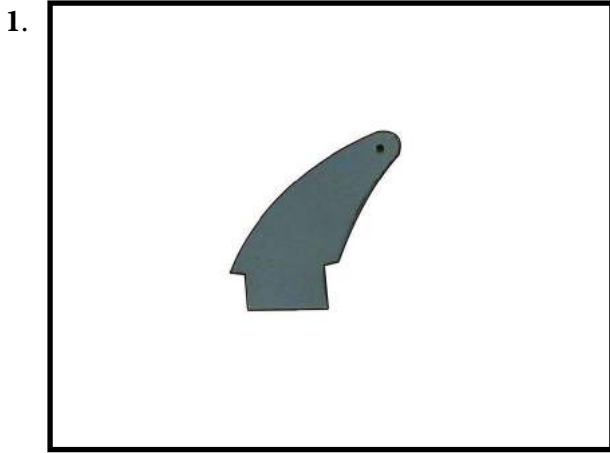

**ELEVATOR PUSHROD
INSTALLATION**

Install the elevator control horn using the same method as with the aileron control horns.

Position the elevator control horn on the both side of elevator.



Thread one clevis and M2 lock nut on to each elevator control rod. Thread the horns on until they are flush with the ends of the control rods.

Elevator and rudder pushrods assembly as pictures below.

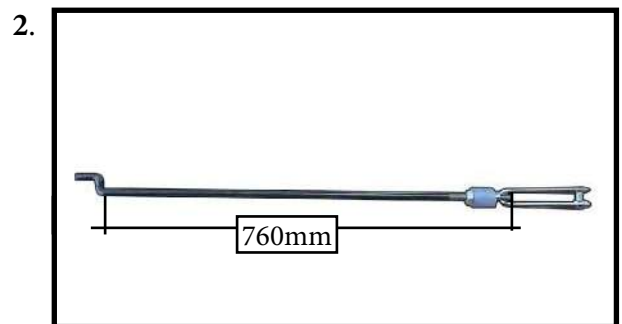

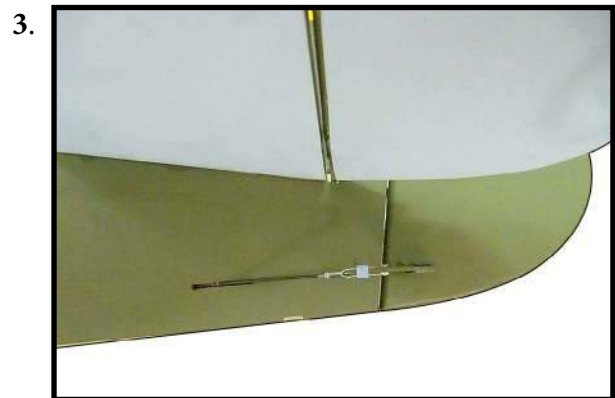
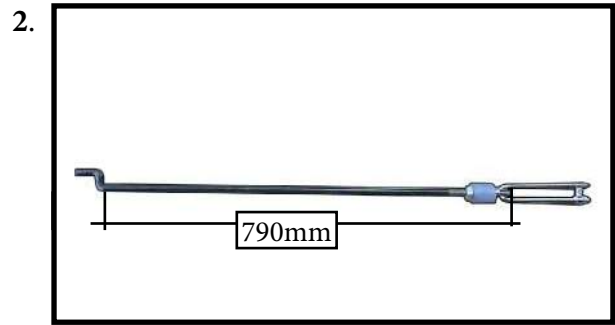
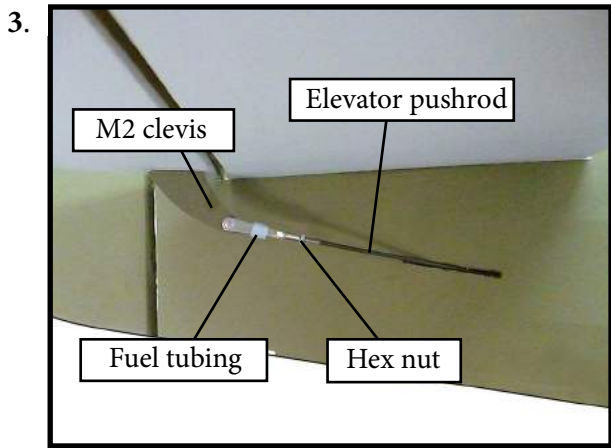

**RUDDER PUSHROD
INSTALLATION**

Repeat steps as same as steps done for elevator.

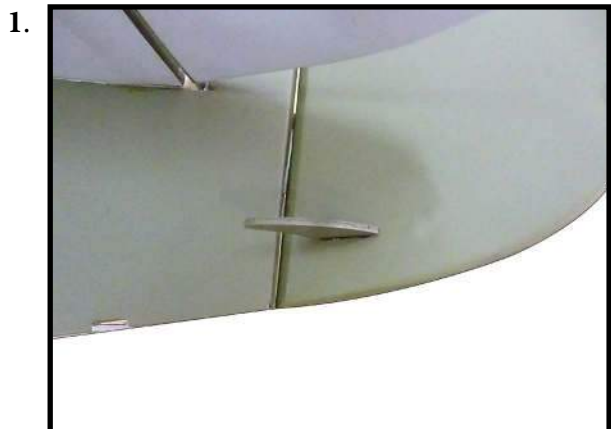

MOUNTING THE TAIL WHEEL

Locate items necessary to install tail wheel.

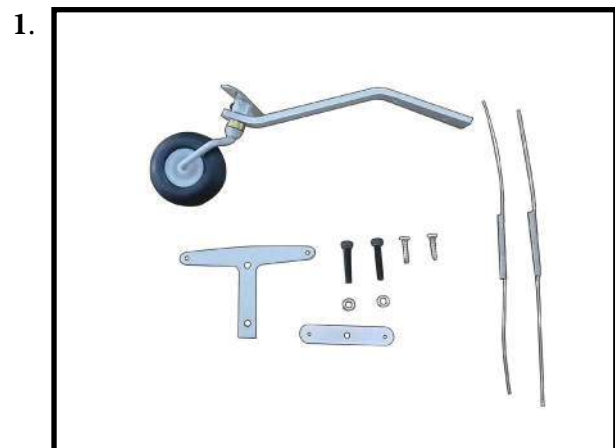

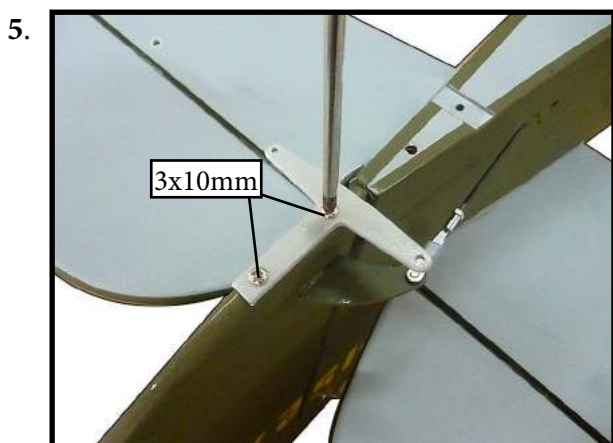
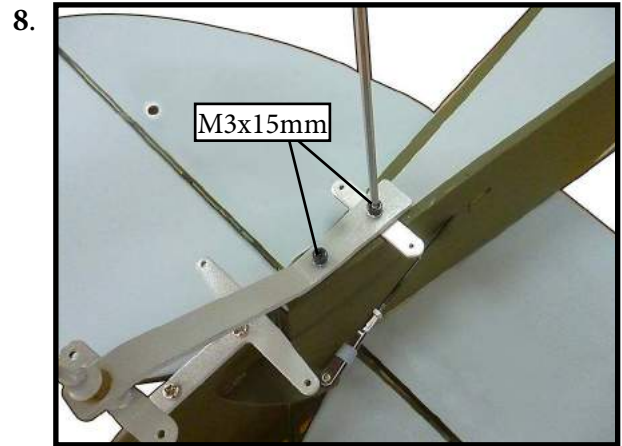
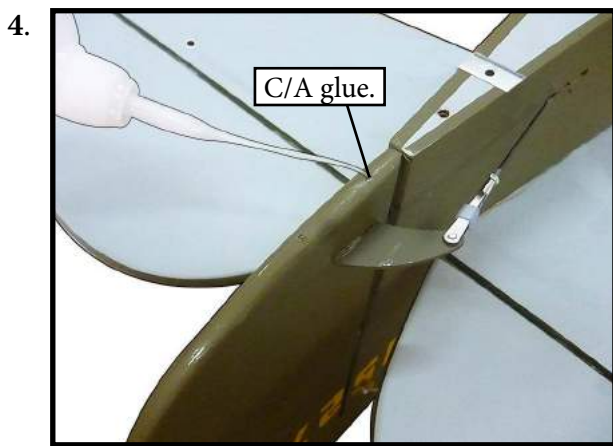
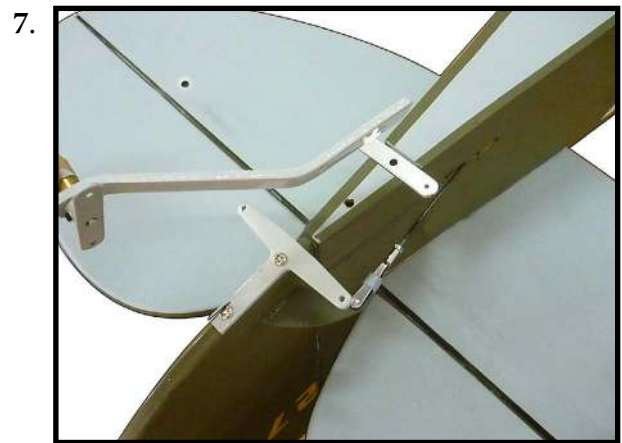
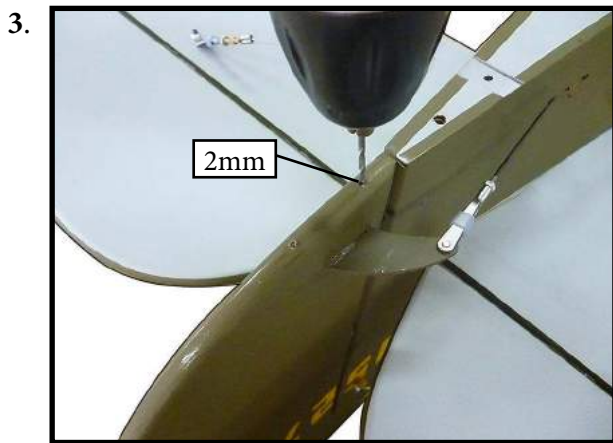

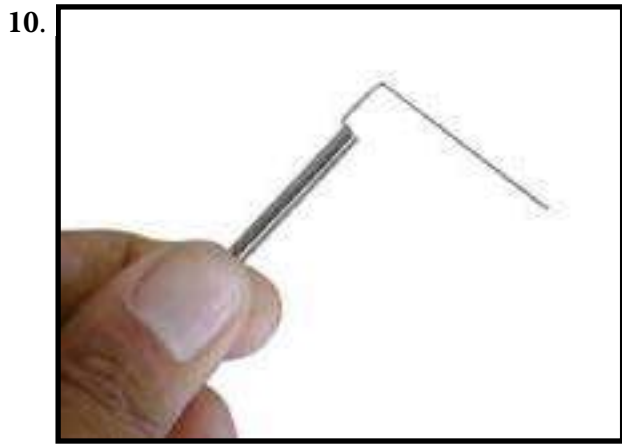

INSTALL BRACING WIRE AND METAL BRACKET AT THE TAIL

TOP VIEW.

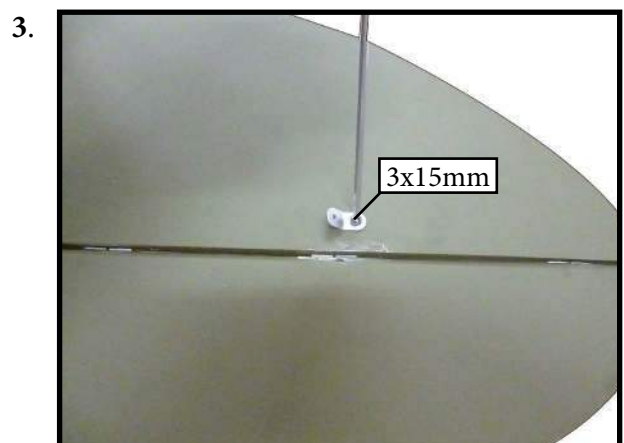
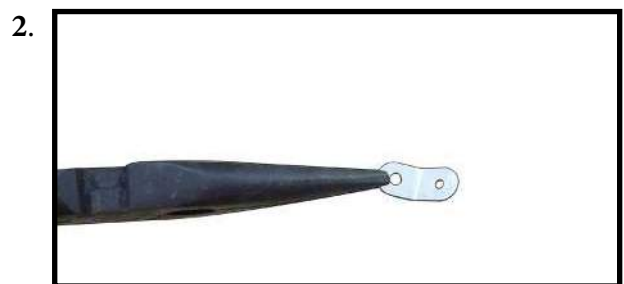
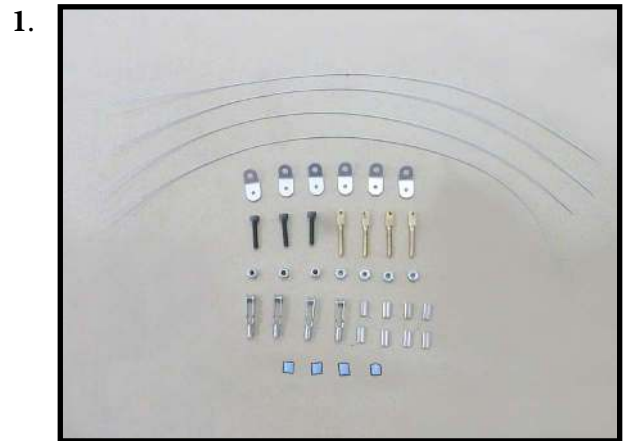
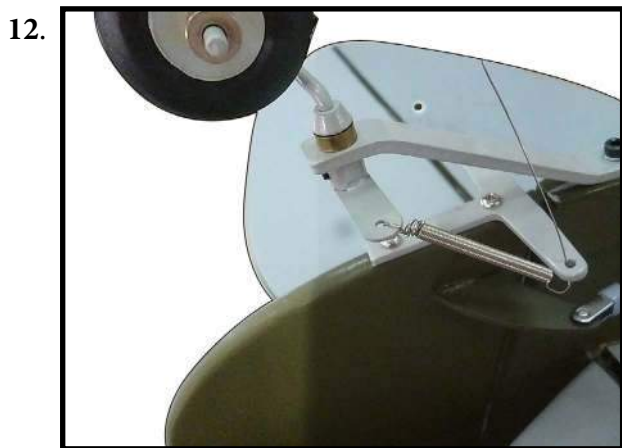

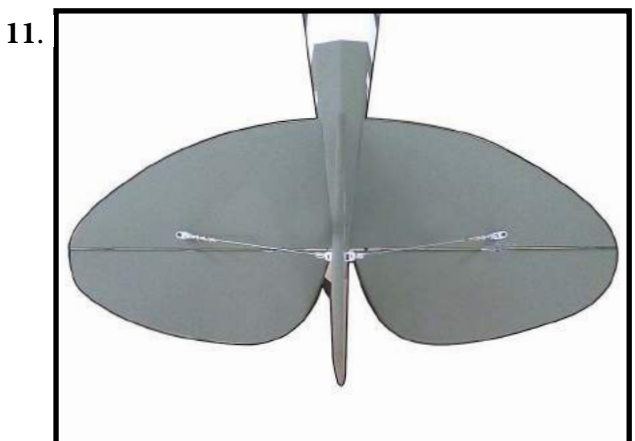
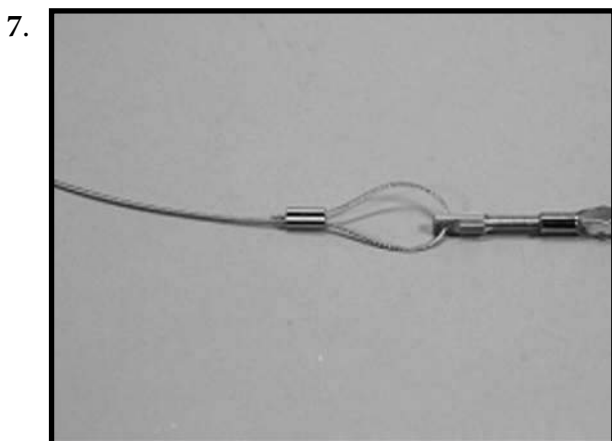
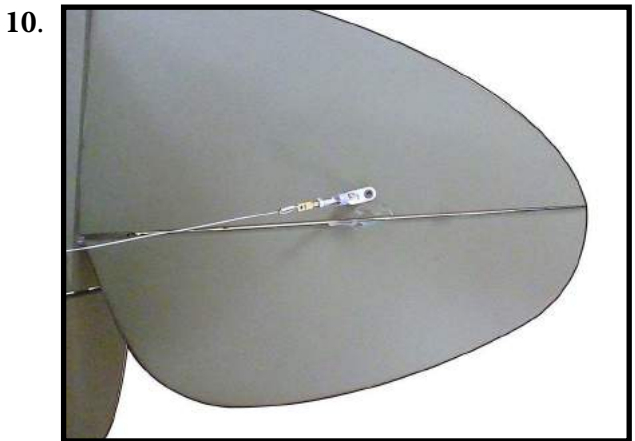
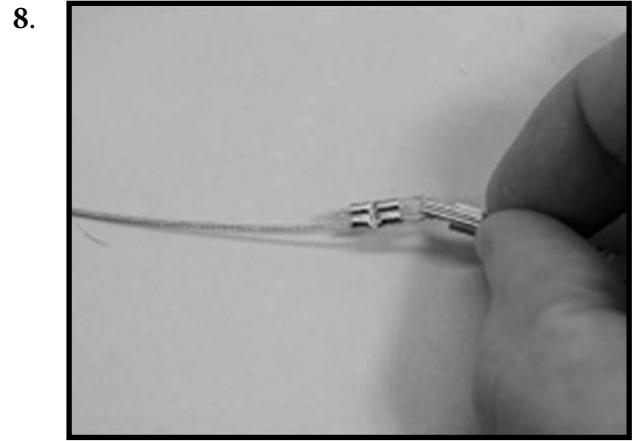

BOTTOM VIEW

12.



13.



14.

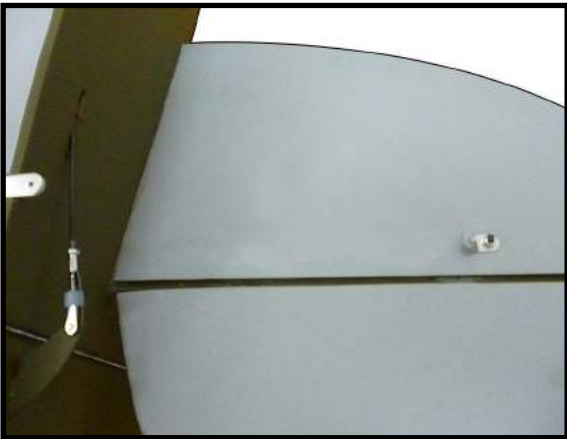

15.



16.

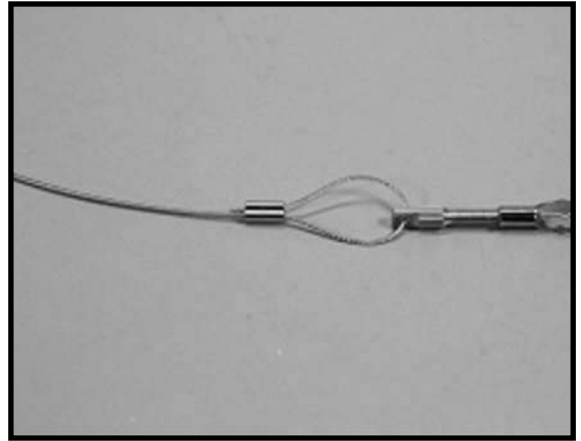

17.

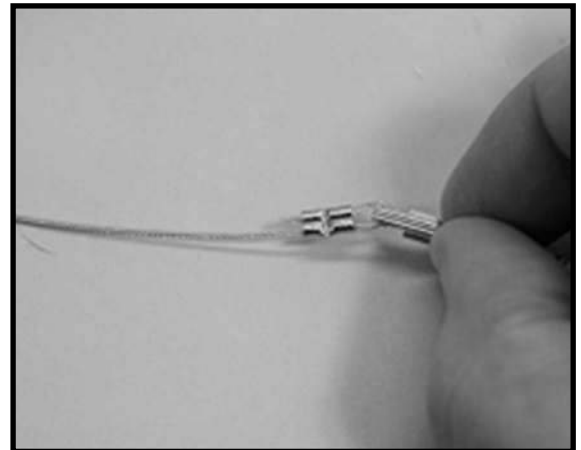

18.

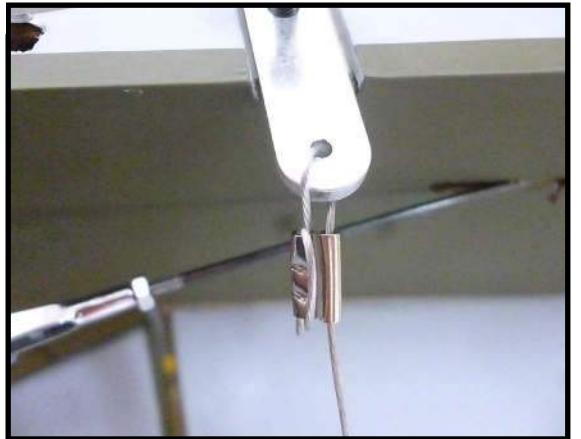

19.

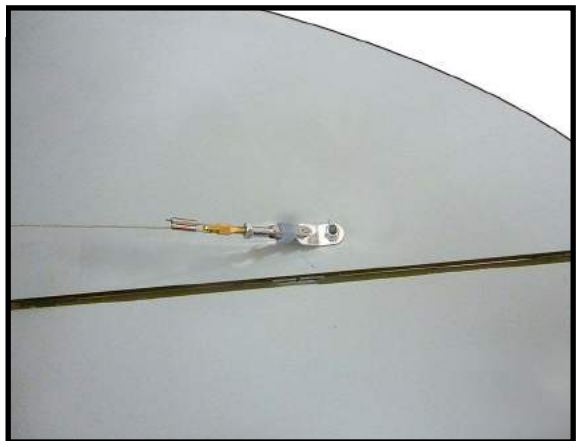

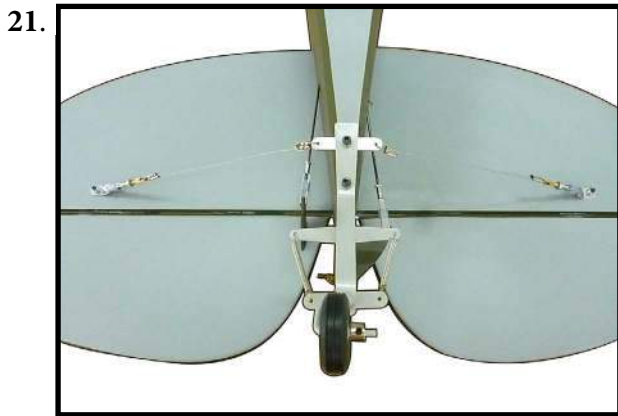
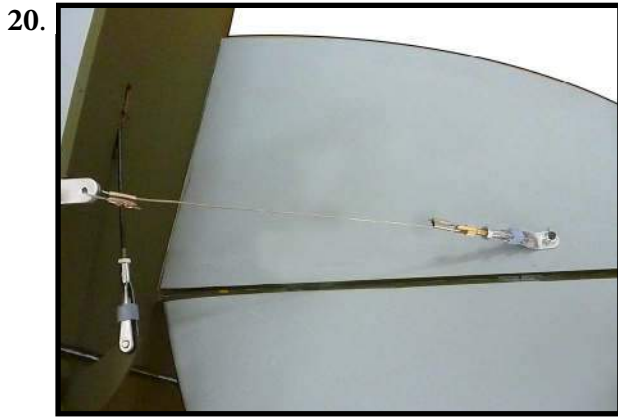

SIDE DOOR INSTALLTION

Please see below pictures.



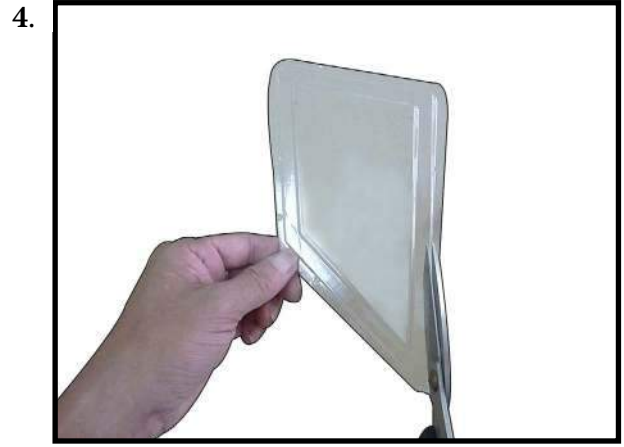

INSTALL WINDSHIELD OF THE SIDE DOOR

Please see below pictures.

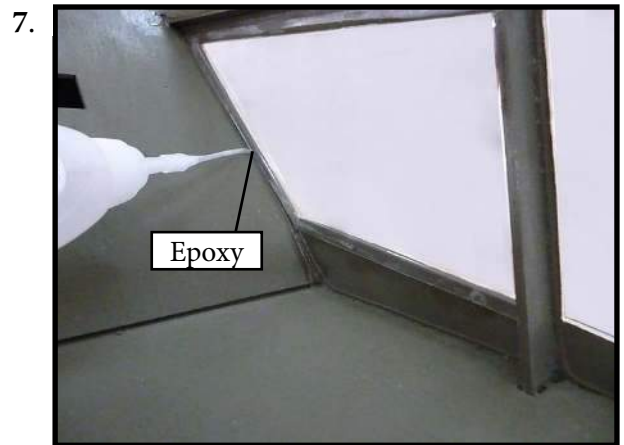
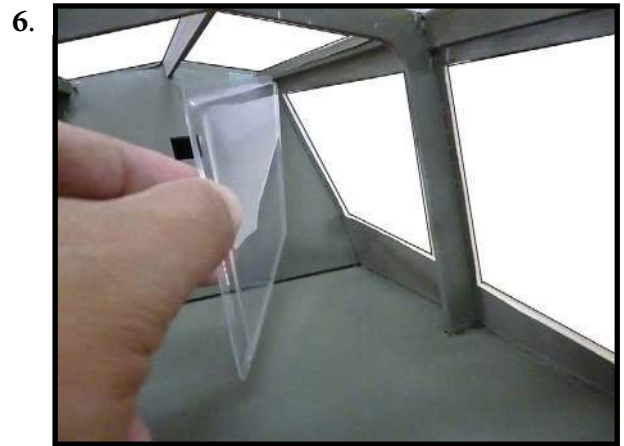
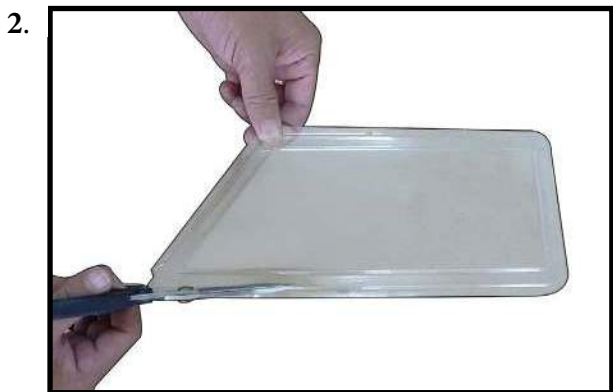
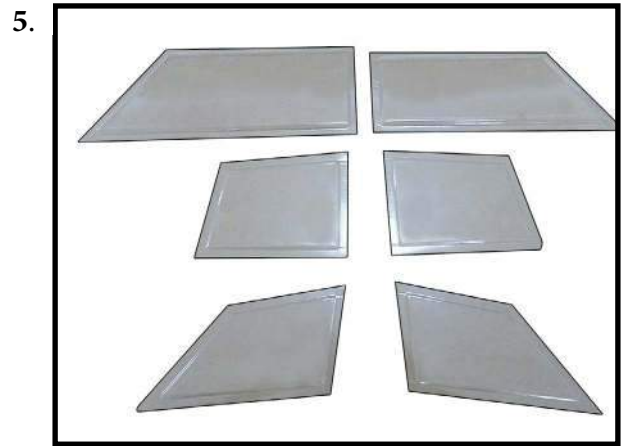

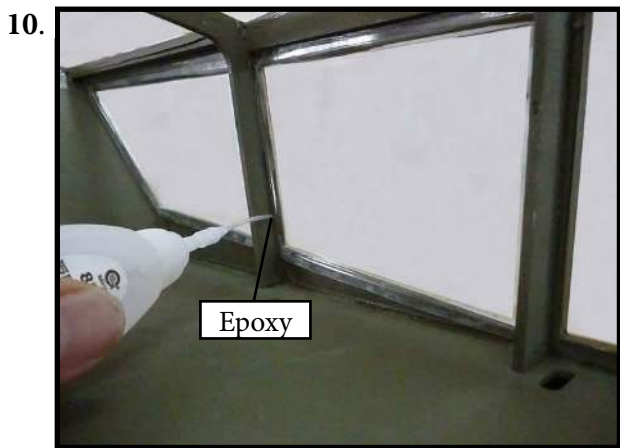
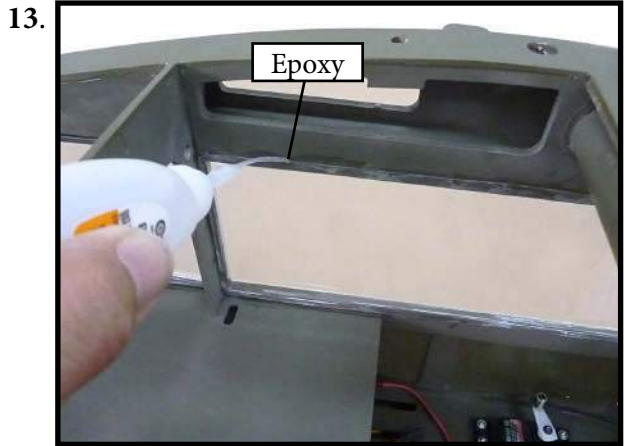
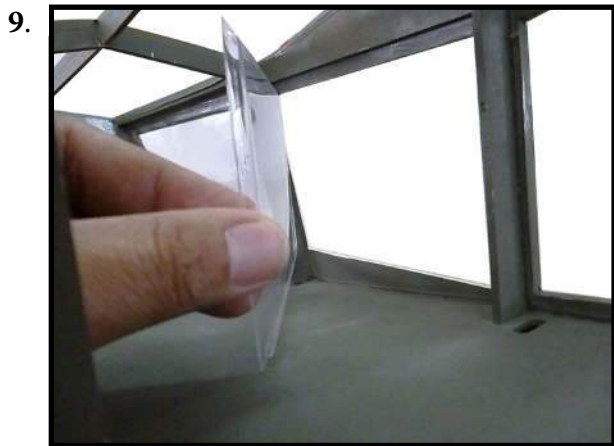

INSTALLATION PILOT AND CANOPY

Locate items necessary to install pilot and canopy.

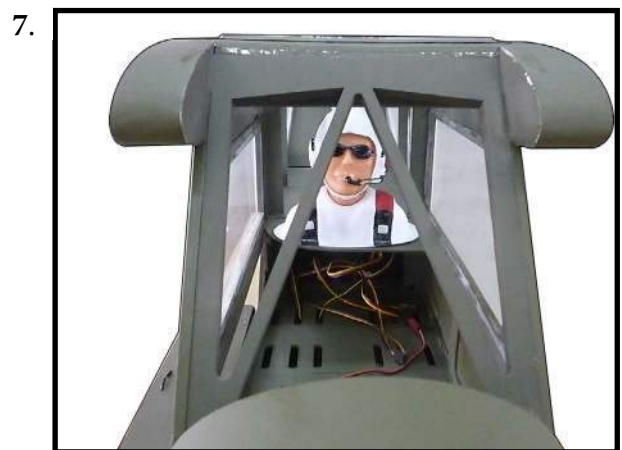
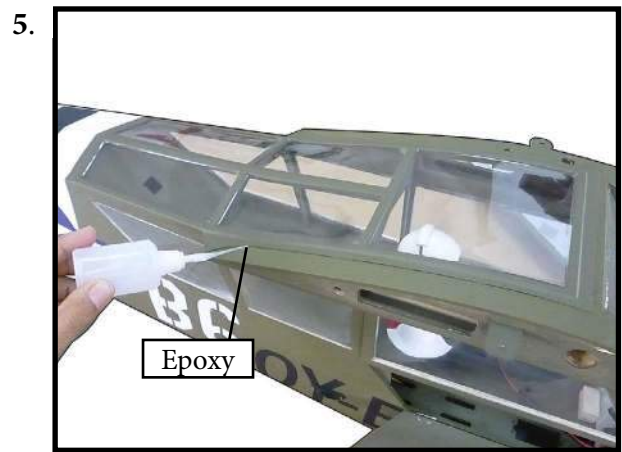
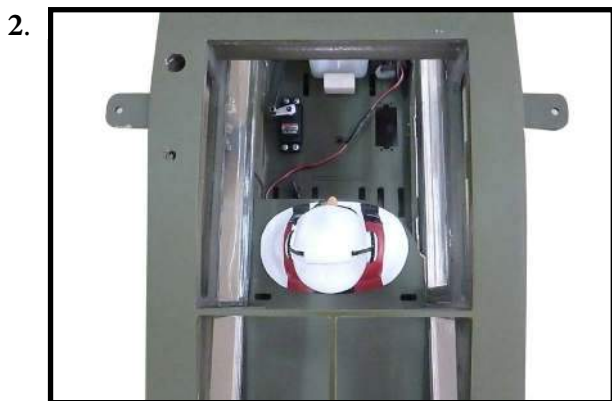

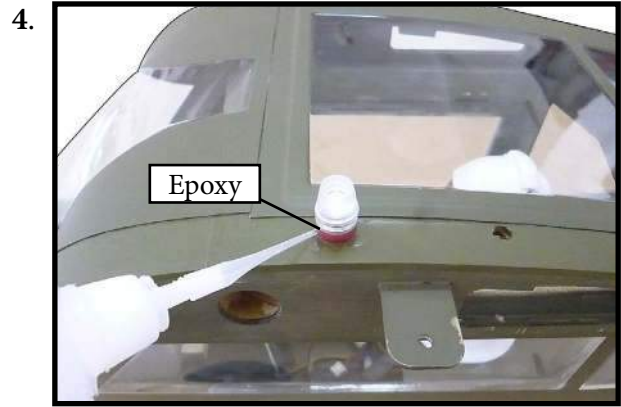

INSTALLING BATTERIES AND LEDS

Please see below pictures.

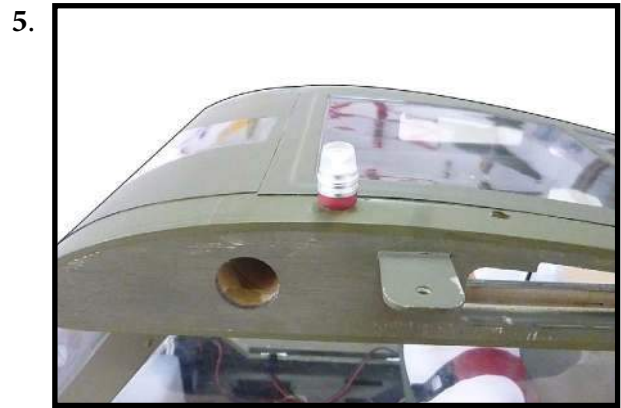

INSTALLING NEEDED ANTEN

Lamp voltage 12v, use appropriate battery.

Parts requirement. See pictures below.

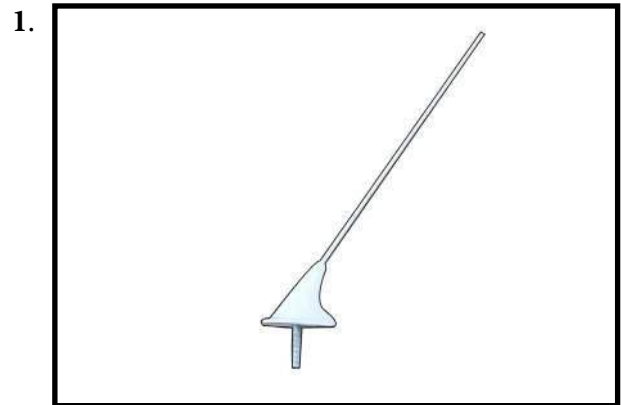

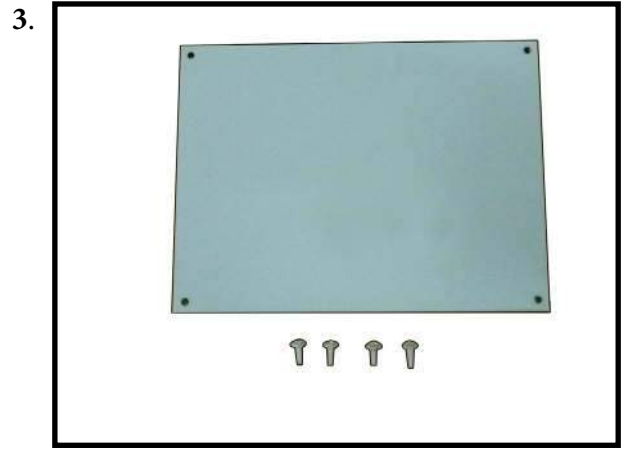
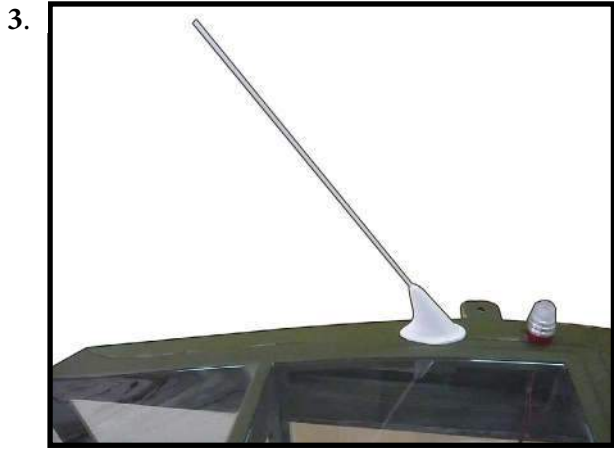

INSTALLING BATTERY - RECEIVER

Plug the servos leads and the switch lead into the receiver. Plug the battery pack lead into the switch also.

Wrap the receiver and battery pack in the protective foam rubber to protect them from vibration.

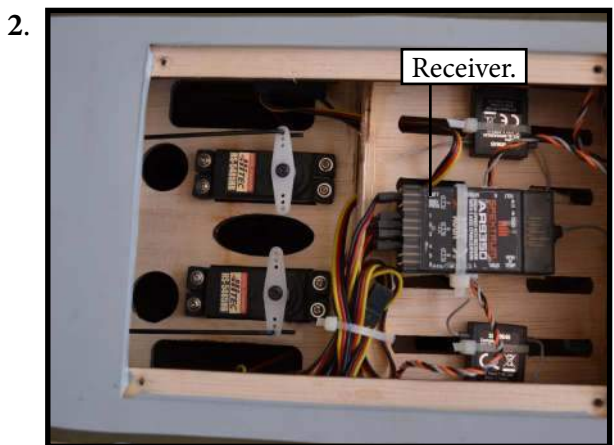
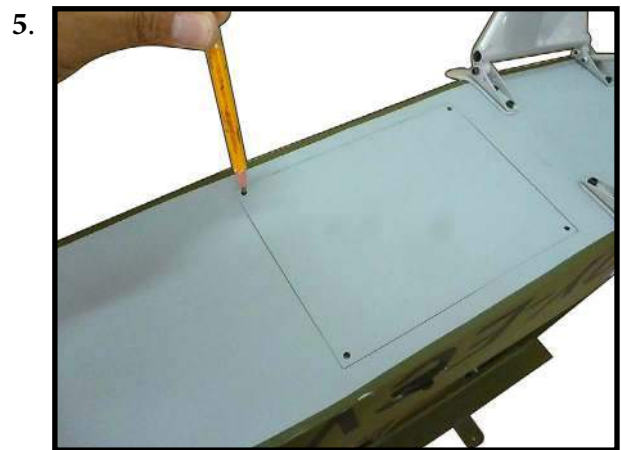
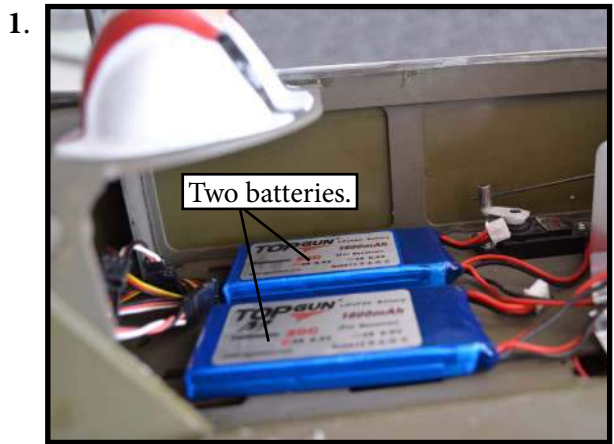

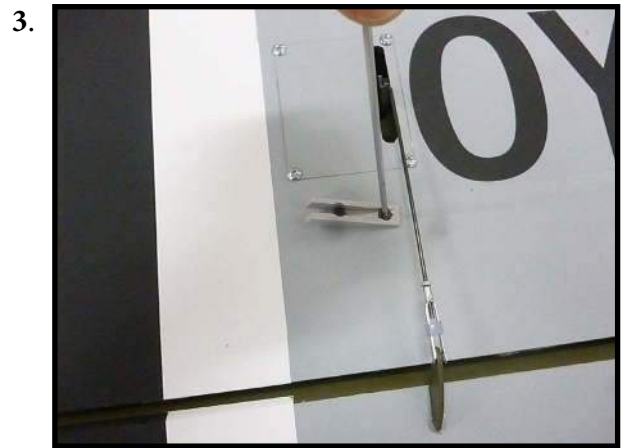
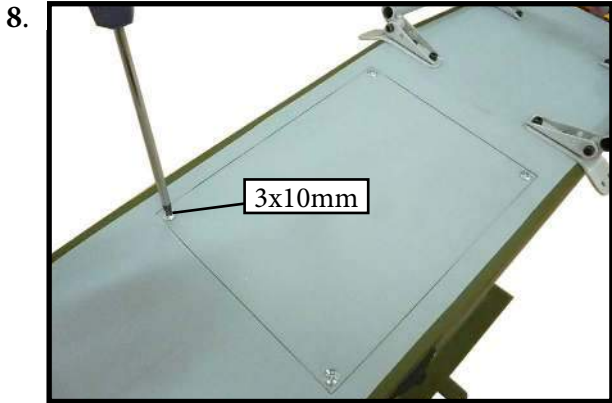
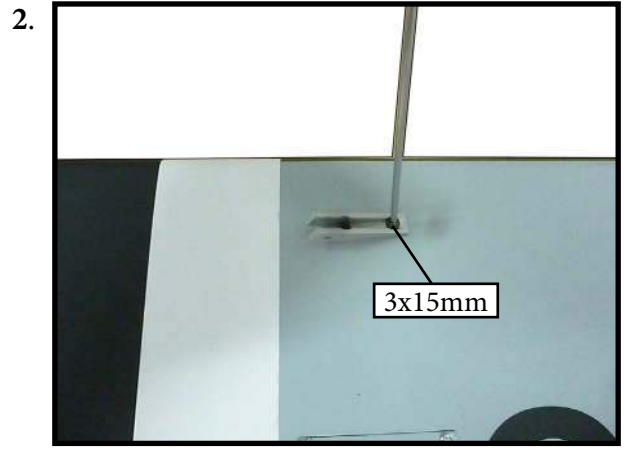
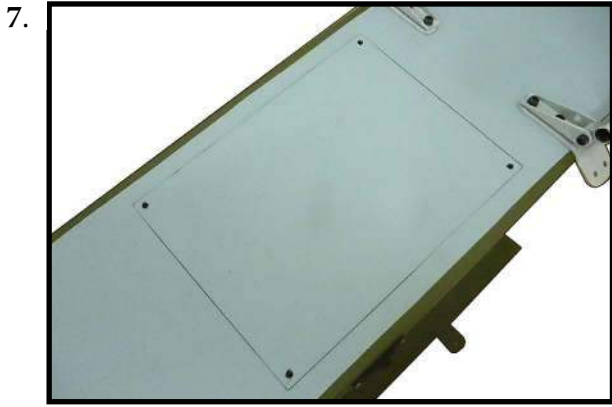

INSTALLATION WING STRUTS

Locate the items for this section of the manual.

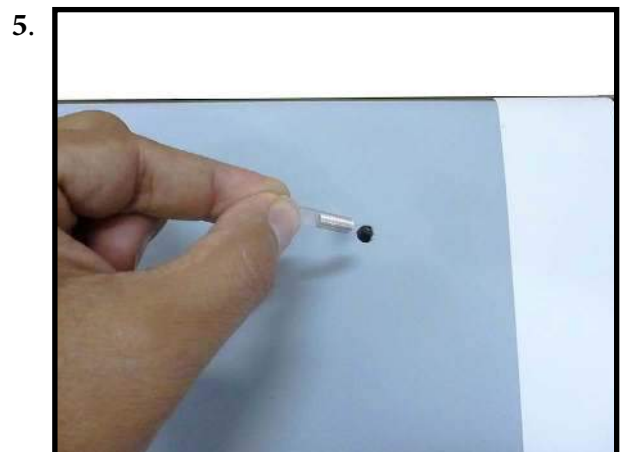

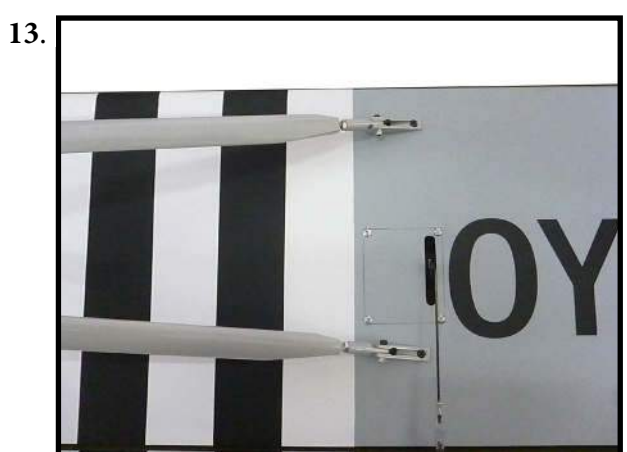
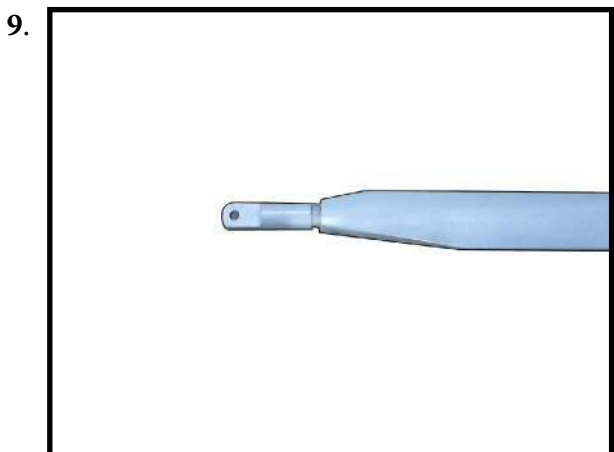
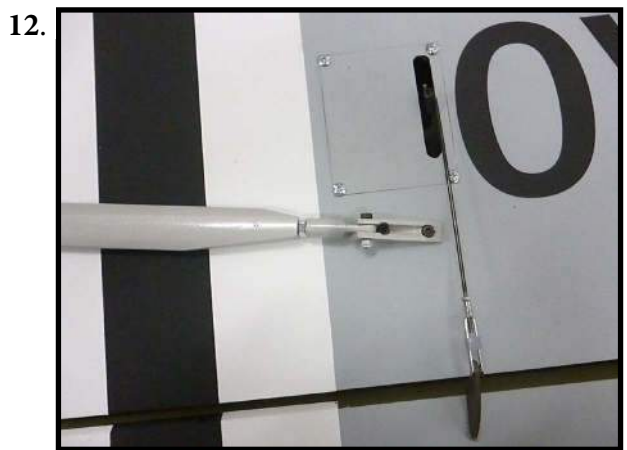
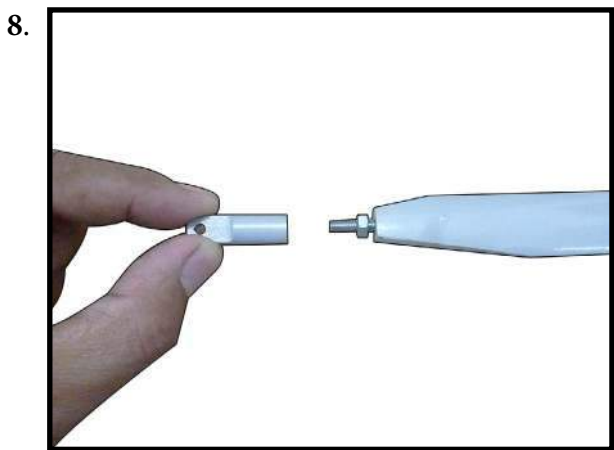
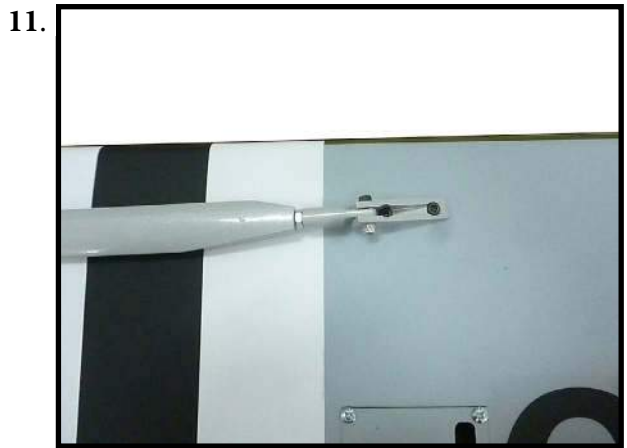
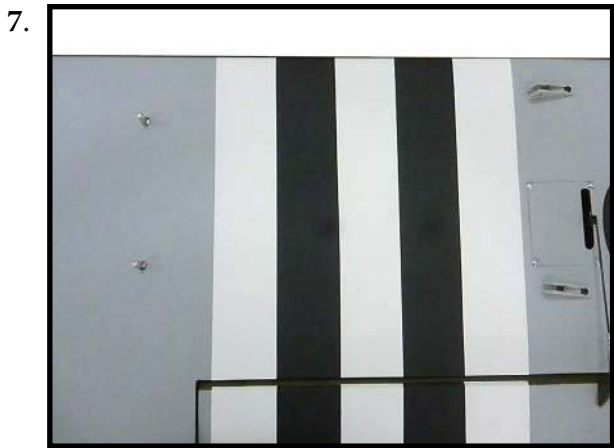
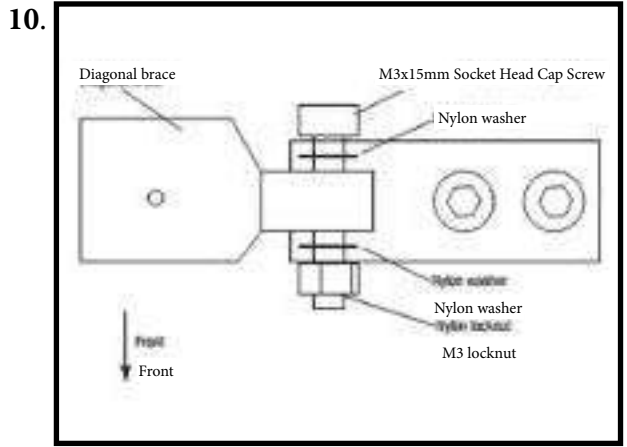

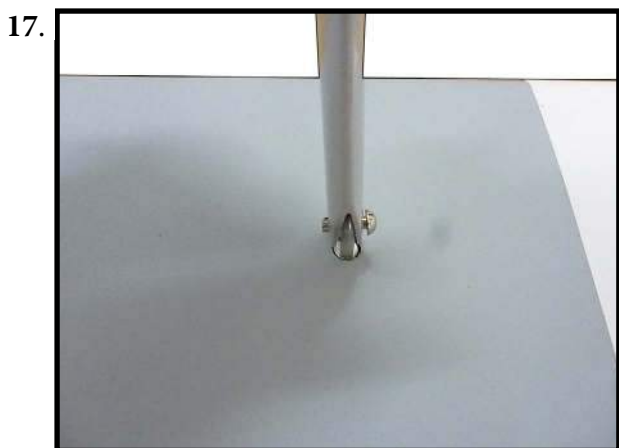
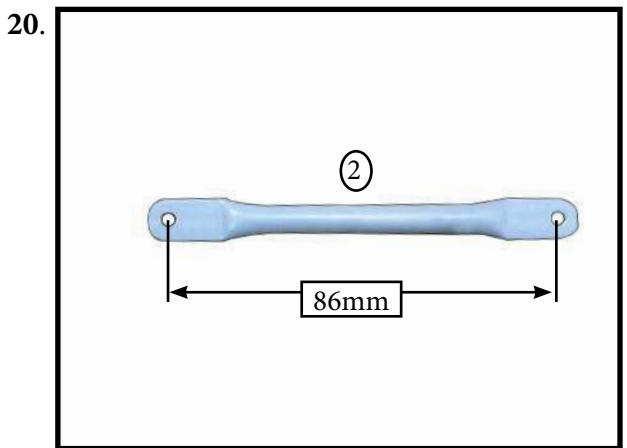
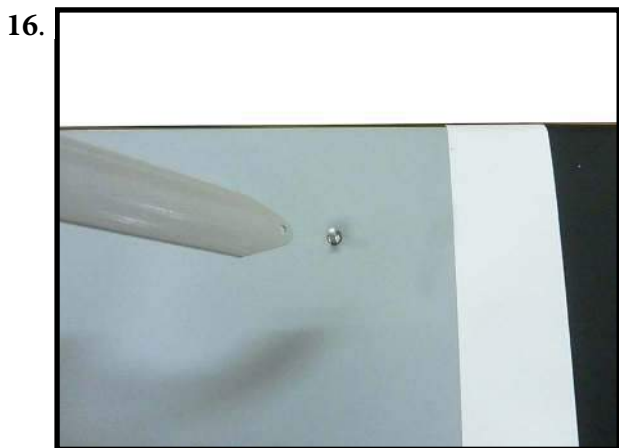
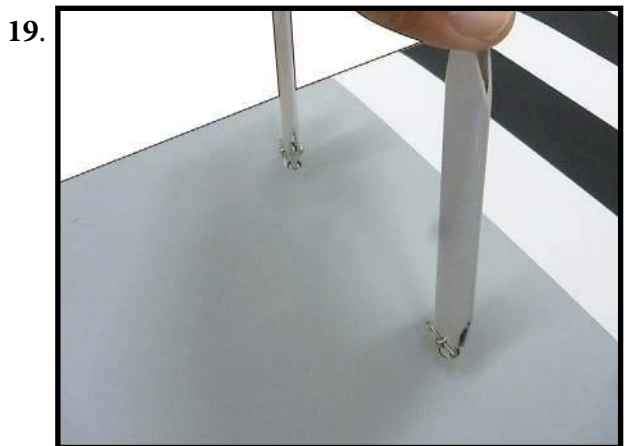
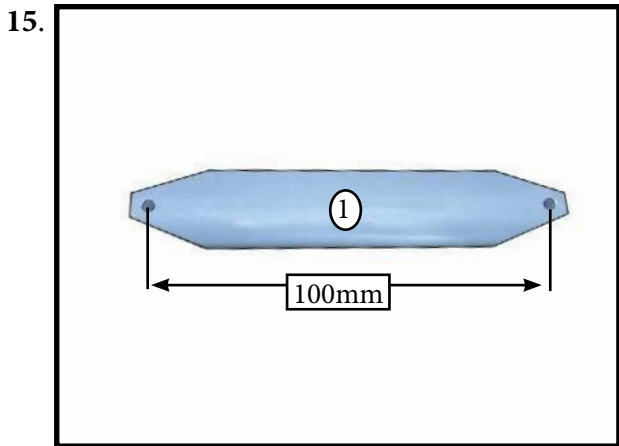
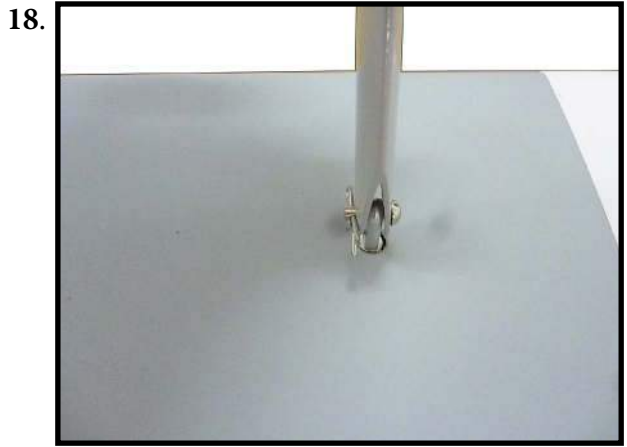
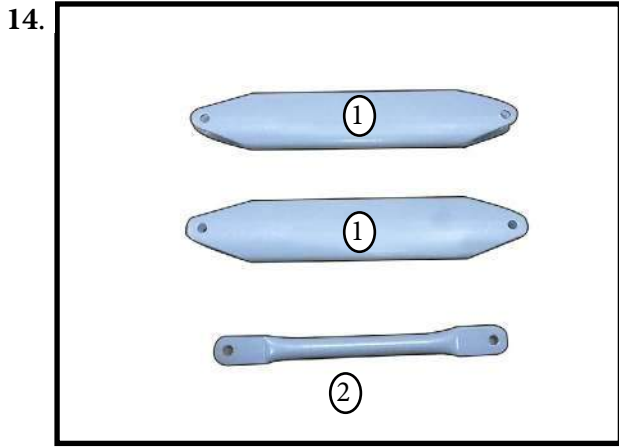

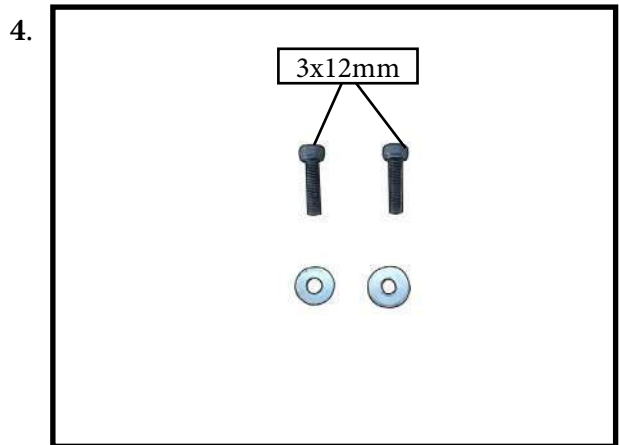
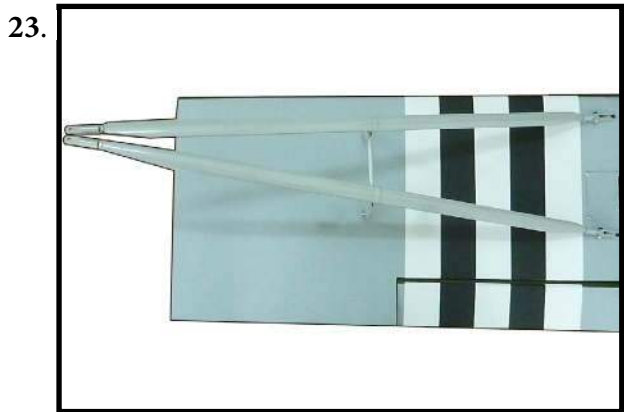
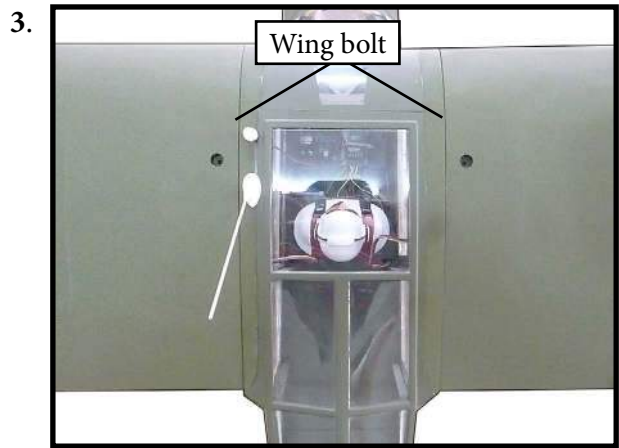
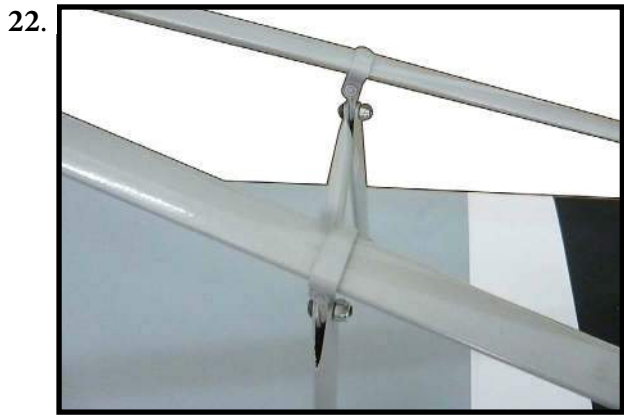

ATTACHMENT WING - FUSELAGE

Attach the aluminium tube into fuselage.

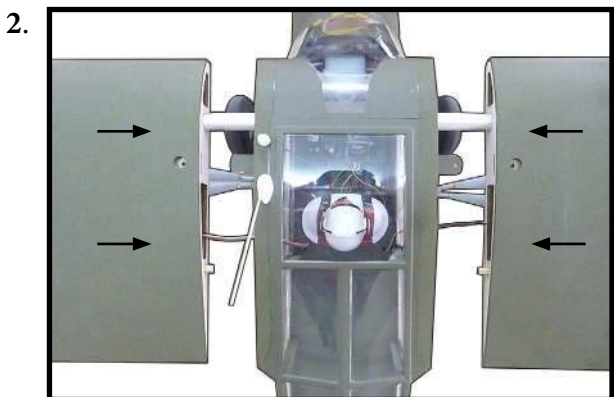
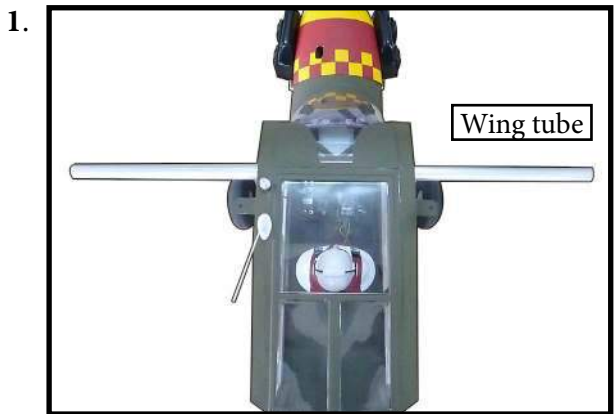

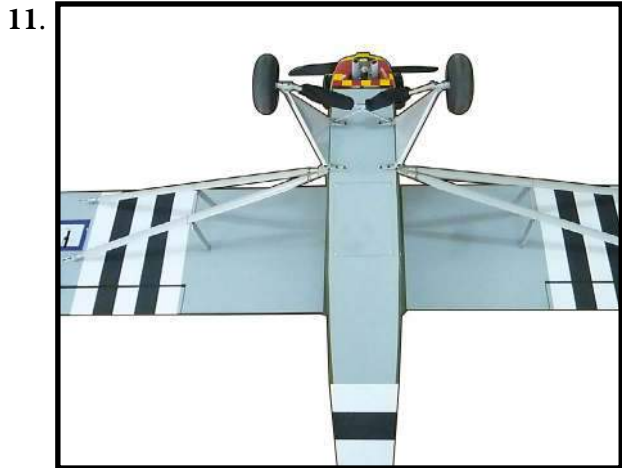
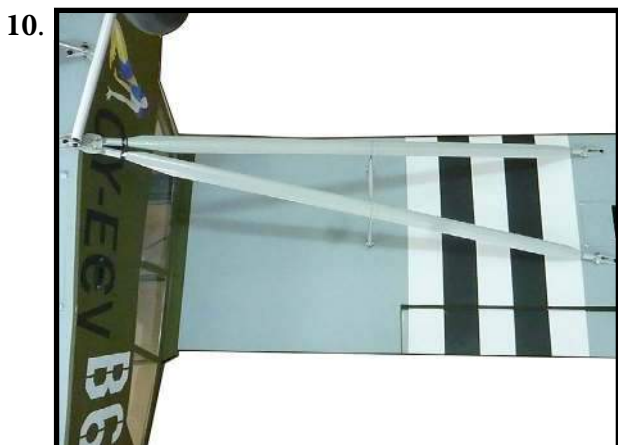

APPLY THE DECALS

If all the decals are precut and ready to stick. Please be certain the model is clean and free from oily fingerprints and dust. Position decal on the model where desired, using the photos on the box and aid in their location.

If all the decals are not precut, please use scissors or a sharp hobby knife to cut the decals from the sheet. Please be certain the model is clean and free from oily fingerprints and dust. Position decal on the model where desired, using the photos on the box and aid in their location.

BALANCING

It is critical that your airplane be balanced correctly. Improper balance will cause your plane to lose control and crash. THE CENTER OF GRAVITY IS LOCATED **100MM** BACK FROM THE LEADING EDGE OF THE WING AT THE WING ROOT.

Mount the wing to the fuselage. Place a piece of masking tape on the top of each wing 100mm back from the leading edge at the wing root.

With the model inverted, place your fingers on the masking tape and carefully lift the plane. This is the point at which your model should balance for your first flights. Later, you may wish to experiment by shifting the balance up to 10mm forward or back to change the flying characteristics. Moving the balance forward may improve the smoothness and arrow-like tracking, but it may then require more speed for take off and make it more difficult to slow down for landing. Moving the balance aft makes the model more agile with a lighter and snappier "feel". In any case, please start at the location we recommend.

*If possible, first attempt to balance the model by changing the position of the receiver battery and receiver. If you are unable to obtain good balance by doing so, then it will be necessary to add weight to the nose or tail to achieve the proper balance point.

With the wings attached to the fuselage, all parts of the model installed (ready to fly), and empty fuel tanks, hold the model at the marked balance point with the stabilizer level.

Lift the model. If the tail drops when you lift, the model is "tail heavy" and you must add weight* to the nose. If the nose drops, it is "nose heavy" and you must add weight* to the tail to balance.

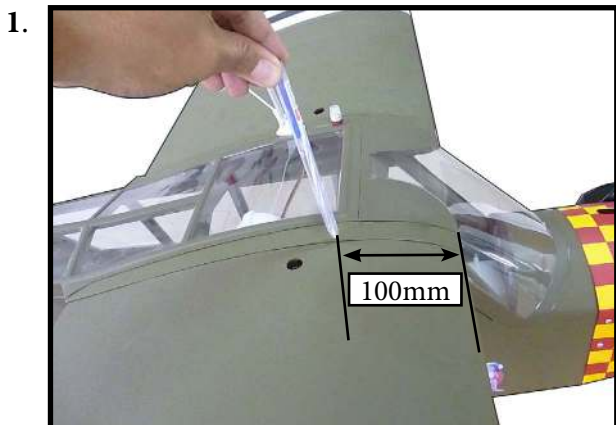

CONTROL THROWS

Ailerons:	Rudder:
High Rate :	High Rate :
Up : 30 mm	Right : 40 mm
Down : 30 mm	Left : 40 mm
Low Rate :	Low Rate :
Up : 20 mm	Right : 30 mm
Down : 20 mm	Left : 30 mm
Elevator:	
High Rate :	
Up : 30 mm	
Down : 30 mm	
Low Rate :	
Up : 20 mm	
Down : 20 mm	

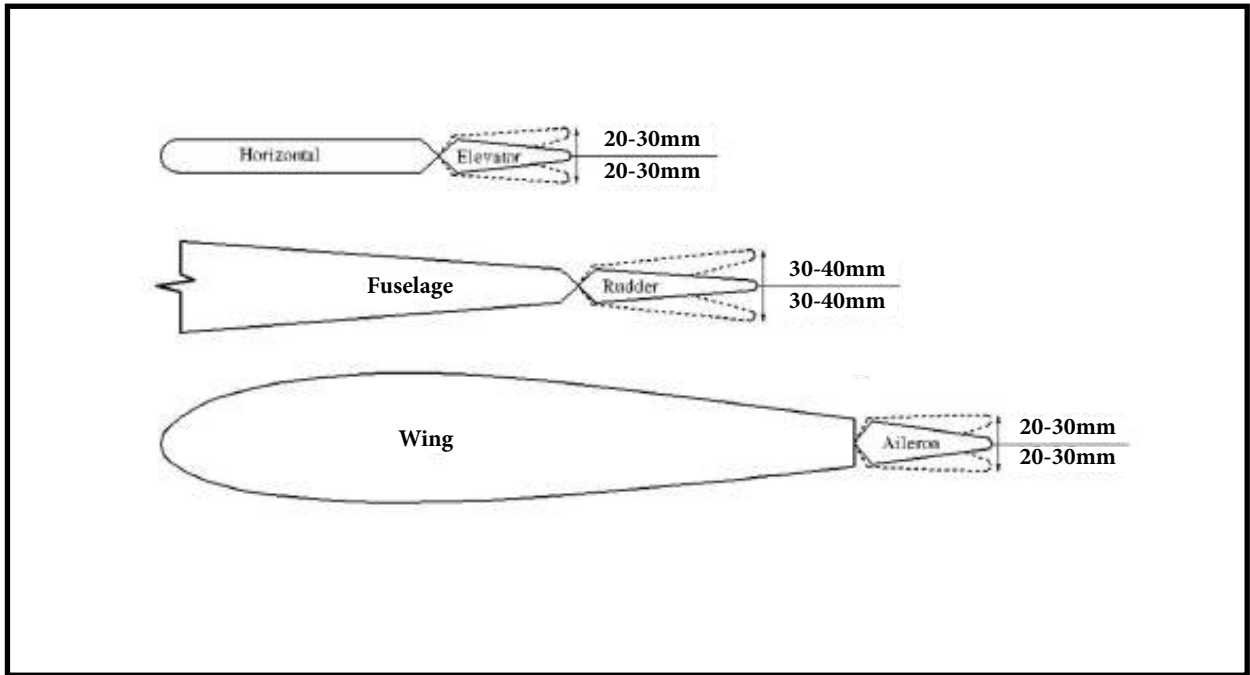

FLIGHT PREPARATION

Check the operation and direction of the elevator, rudder, ailerons and throttle.

A) Plug in your radio system per the manufacturer's instructions and turn everything on.

B) Check the elevator first. Pull back on the elevator stick. The elevator halves should move up. If they do not, flip the servo reversing switch on your transmitter to change the direction.

C) Check the rudder. Looking from behind the airplane, move the rudder stick to the right. The rudder should move to the right. If it does not, flip the servo reversing switch on your transmitter to change the direction.

D) Check the throttle. Moving the throttle stick forward should open the carburetor barrel. If it does not, flip the servo reversing switch on your transmitter to change the direction.

E) From behind the airplane, look at the aileron on the right wing half. Move the aileron stick to the right. The right aileron should move up and the other aileron should move down. If it does not, flip the servo reversing switch on your transmitter to change the direction.

PREFLIGHT CHECK

1) Completely charge your transmitter and receiver batteries before your first day of flying.

2) Check every bolt and every glue joint in the **L-4 Grasshopper 90 inches** to ensure that everything is tight and well bonded.

3) Double check the balance of the airplane. Do this with the fuel tank empty.

4) Check the control surfaces. All should move in the correct direction and not bind in any way.

5) If your radio transmitter is equipped with dual rate switches double check that they are on the low rate setting for your first few flights.

6) Check to ensure the control surfaces are moving the proper amount for both low and high rate settings.

7) Check the receiver antenna. It should be fully extended and not coiled up inside the fuselage.

8) Properly balance the propeller. An out of balance propeller will cause excessive vibration which could lead to engine and/or airframe failure.

*We wish you many safe and enjoyable flights
with your L-4 Grasshopper 90 inches.*

*If you have any queries, or are interested in our products,
please feel free to contact us*

Factory : 12/101A - Hamlet 4 - Le Van Khuong Street - Dong Thanh Ward -
Hoc Mon District - Ho Chi Minh City - Viet Nam.

Office : 62/8 Ngo Tat To Street - Ward 19 - Binh Thanh District - Ho Chi Minh
City - Viet Nam

Phone : 848 - 86622289 or 848- 36018777

Website : www.SeagullModels.com

Email : Sales@seagullmodels.com

Facebook : www.facebook.com/SeaGullModels.