



HSD

Furious 200

www.hsdhobby.com



NOTICE

Thank you for purchasing from HSD. Please read this manual carefully before operating this plane. We hope this manual is useful in guiding you through the installation and adjustment of the plane so that you may fly it successfully.

Each product from HSD has unique functions that users will need to fully grasp step by step, as the assembly will be completed by you. It is necessary to assemble and test the product strictly in accordance with the standards of HSD.

All rights reserved by HSD for the upgrade and/or reconfiguration of products.

Meaning of Special Language:

The following terms are used throughout the product literature to indicate various levels of potential harm when operating this product:

NOTICE: If procedures are not properly followed, the risk of physical property damage AND a possibility of serious injury are likely.

CAUTION: If procedures are not properly followed, the risk of physical property damage AND a possibility of serious injury are likely.

WARNING: If procedures are not properly followed, the risk of physical property damage AND a possibility of serious injury are likely.



WARNING: Read this instruction manual in its entirety to become thoroughly familiar with the features of the product before operating. Failure to operate the product correctly can result in damage to the product, personal property and cause serious injury.

This is a sophisticated hobby product. It must be operated with caution and common sense and requires some basic mechanical ability. Failure to operate this Product in a safe and responsible manner could result in injury or damage to the product or other property. This product is not intended for use by children without direct adult supervision. Do not use with incompatible components or alter this product in any way outside of the instructions provided by HSD HOBBY LTD. This manual contains instructions for safety, operation and maintenance. It is essential to read and follow all the instructions and warnings in the manual, prior to assembly, setup or use, in order to correctly operate and/or avoid damage or serious injury.

14+ AGE RECOMMENDATION:

Not for children under 14 years. This is not a toy.

Safety Precautions and Warnings

As the user of this product, you are solely responsible for operating in a manner that does not endanger yourself and others nor result in damage to the product and property of others.

- Always keep a safe distance in all directions around your model to avoid collisions or injury. This model is controlled by a radio signal subject to interference from many sources outside your control; interference can cause momentary loss of control
- Always operate your model in open spaces away from full-size vehicles, traf and people.
- Always carefully follow the directions and warnings for this and any optional support equipment (chargers, rechargeable battery packs, etc.).
- Always keep all chemicals, small parts and anything electrical out of the reach of children.
- Always avoid water exposure to all equipment not specifically designed and protected for this purpose. Moisture causes damage to electronics.
- Never place any portion of the model in your mouth as it could cause serious injury or even death.
- Never operate your model with low transmitter batteries.
- Always keep aircraft in sight and under control.
- Always use fully charged batteries.
- Always keep transmitter powered on while aircraft is powered.
- Always remove batteries before disassembly.
- Always keep moving parts clean.
- Always keep parts dry.
- Always let parts cool after use before touching.
- Always remove batteries after use.
- Always ensure failsafe is properly set before flying .
- Never operate aircraft with damaged wiring.
- Never touch moving parts.

Charging Warnings

CAUTION: All instructions and warnings must be followed exactly. Mishandling of Li-Po batteries can result in a fire, personal injury, and/or property damage.

- By handling, charging or using the included Li-Po battery, you assume all risks associated with lithium batteries.
- If at any time the battery begins to balloon or swell, discontinue use immediately. If charging or discharging, discontinue and disconnect. Continuing to use, charge or discharge a battery that is ballooning or swelling can result in fire.
- Always store the battery at room temperature in a dry area for best results.
- Always transport or temporarily store the battery in a temperature range of 40-120° F (5-49° C) . Do not store battery or aircraft in a car or direct sunlight. If stored in a hot car, the battery can be damaged or even catch fire.
- Always charge batteries away from flammable materials.
- Always inspect the battery before charging and never charge dead or damaged batteries.
- Always disconnect the battery after charging, and let the charger cool between charges.
- Always consistently monitor the temperature of the battery pack while charging.
- **ONLY USE A CHARGER SPECIFICALLY DESIGNED TO CHARGE LI-PO BATTERIES.** Failure to charge the battery with a compatible charger may cause fire resulting in personal injury and/or property damage.
- Never discharge Li-Po cells to below 3V under load.
- Never cover warning labels with hook and loop strips.
- Never leave charging batteries unattended.
- Never charge children outside recommended levels.
- Never attempt to dismantle or alter the charger.
- Never allow minors under the age of 14 to charge battery packs.
- Never charge batteries in extremely hot or cold places (recommended between 40-120° F or 5-49x C) or place in direct sunlight.

CONTENTS





| | |
|--|----|
| Box Contents..... | 01 |
| Specifications..... | 01 |
| Assembly..... | 02 |
| Control Horn and Servo Arm Settings..... | 03 |
| Control Direction Test..... | 04 |
| Clevis Installation..... | 05 |
| Control Surface Centering..... | 05 |
| Throttle Range Setting..... | 05 |
| CG Location..... | 06 |
| Accessories..... | 07 |
| Trouble Shooting..... | 08 |
| Model Flying Precautions..... | 09 |
| Pre-Flight Checks..... | 09 |

Propeller require Li-PO batteries with a high discharge rating (C rating) for increased safety and optimal performance. We recommend using Li-Po batteries with a minimum of 40C or above.

Box Contents



Specifications

| | |
|---|--|
| | 7X5 / Propeller |
|  | Brushless Outrunner Motor, 2820-1400Kv |
|  | 60A Pro Brushless ESC(2-6S) |
|  | Servos:(metal shell and digital servos)9*4PCS |
|  | Battery:14.8V 2200-3300mAh 40C Li-Po |
|  | Radio System:2.4Ghz 5Ch Transmitter and Receiver |

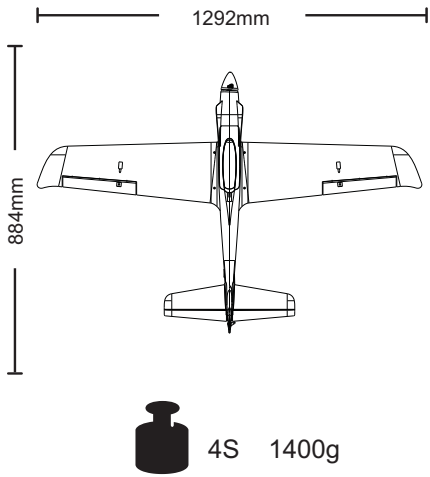

Assembly

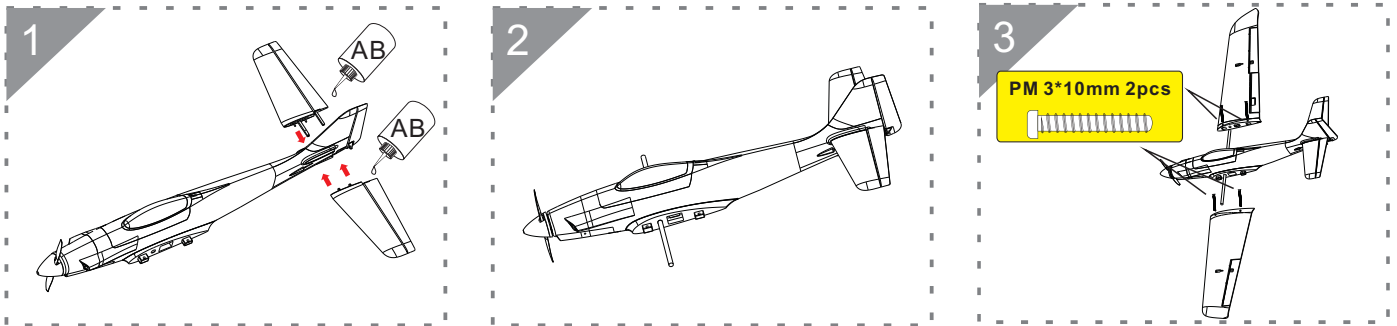

Assembly of your Furious is completed. Now perform a final check on all screws, bolts and components, ensuring all are secure and firmly in place.

Control Horn and Servo Arm Settings

The table to the right shows the factory settings for the control horns and servo arms. Fly the aircraft at factory settings before making changes.

After flying you may choose to adjust the linkage positions for the desired control response. See the lower table.

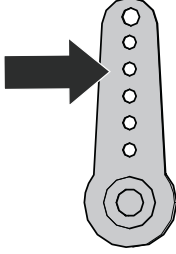
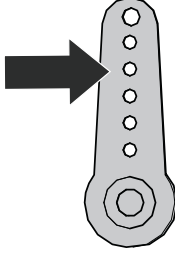
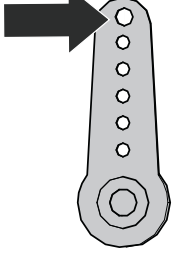
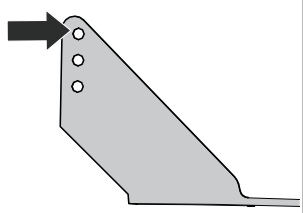
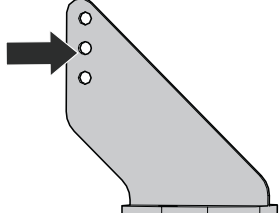
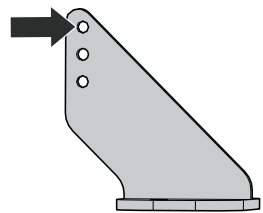
| | Elevator | Rudder | Ailerons |
|-------|---|---|---|
| Horns |  |  |  |
| Arms |  |  |  |

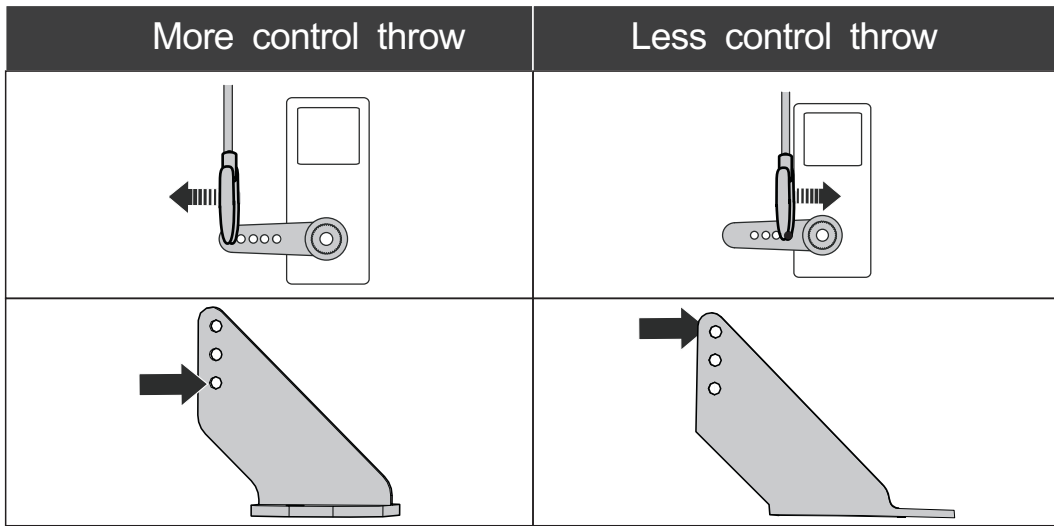



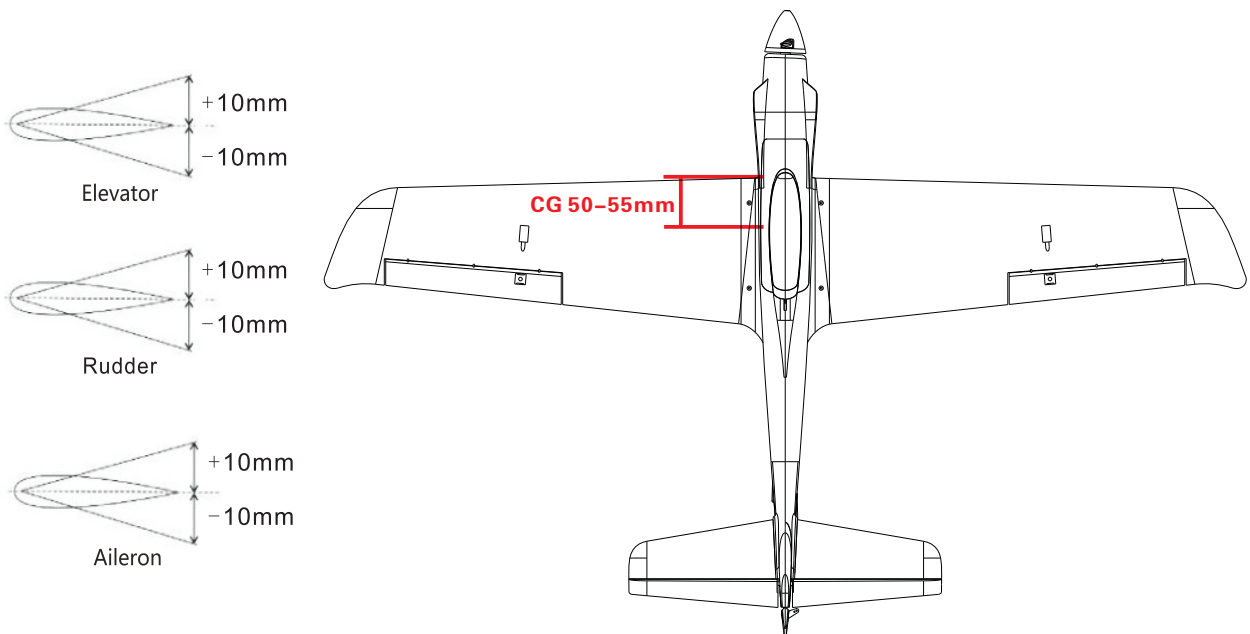

CG LOCATION

Make sure the center of gravity (CG) is as indicated in the following diagram.

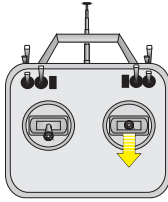
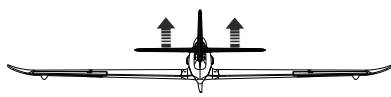
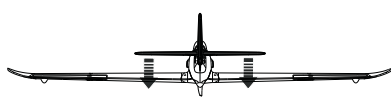
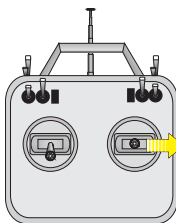
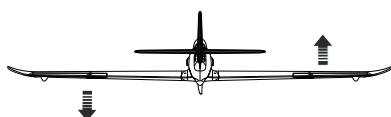

Control Direction Tests

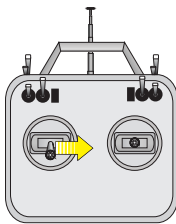
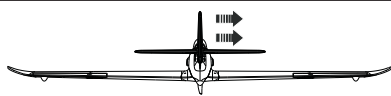
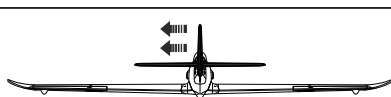
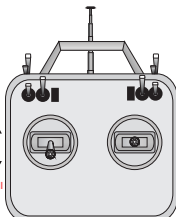
Assemble the aircraft and bind your transmitter to the receiver before performing this test.
 After binding a transmitter to the aircraft receiver, set the trims and sub-trims to 0, then adjust the clevises to center the control surfaces.
 Move the controls on the transmitter to make sure the aircraft control surfaces move in the proper direction.

| | Transmitter Command | Aircraft Reaction |
|---|---------------------------------|--|
|  | Elevator Up Elevator Command |  |
| | Down Elevator Command |  |
|  | Aileron Stick Right |  |
| | Stick Left |  |
|  | Rudder Stick Right |  |
| | Stick Left |  |
|  | the Throttle |  |

Clevis Installation

* Adjust the pushrod and clevis as necessary.

* Carefully adjust the clevis so that it creates a centered surface when attached to the control horn.

Control Surface Centering

After assembly and transmitter setup, verify that the control surfaces are centered. If the control surfaces are not centered, mechanically center the control surfaces by adjusting the linkages.

With the flaps switch in the up position, flaps should be adjusted so they are even with the ailerons and/or the root of the wing.

If adjustments are required, turn the ball buckle on the pushrod to change the length of the linkage between the servo arm and the control horn. After binding a transmitter to the aircraft receiver, set the trims and sub-trims to 0, then adjust the ball buckles as necessary to center the control surfaces.

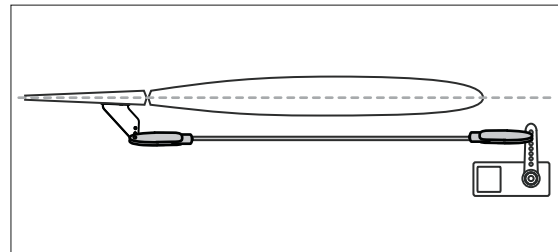
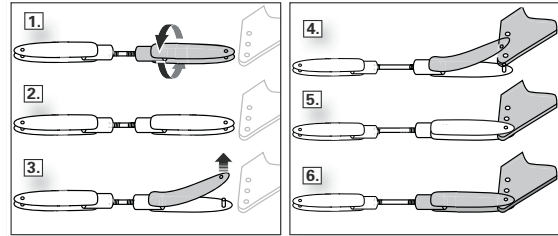

Throttle range setting

(Throttle range should be reset whenever a new transmitter is being used)

Step 1: Switch on the transmitter and move the throttle stick to 100% (wide-open throttle).

Step 2: Connect the battery pack to the ESC, and wait about 2 seconds.

Step 3: A 'beep-beep' tone will emit, this means the highest point in the throttle control range has been confirmed.

Step 4: After the 'beep-beep' tone is emitted, move the throttle stick back down to the lowest position (0%). You will hear a set of initialization beeps that register the number of cells in the battery.

Step 5: A final, long beep tone will be emitted meaning that the lowest point of the throttle range has been confirmed. This means the throttle control has been initialized properly and is ready for use.

Accessories



HSD-F-01

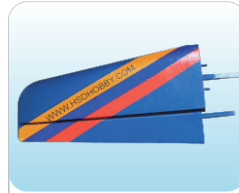

HSD-F-02



HSD-F-03



HSD-F-04



HSD-F-05



HSD-F-06

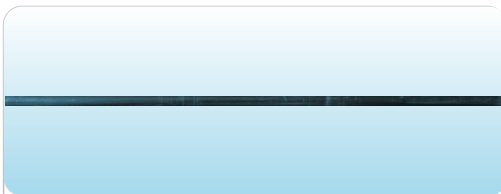

HSD-F-07



HSD-F-08



HSD-F-09

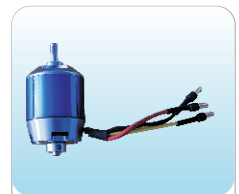

HSD-F-10



HSD-F-11



HSD-F-12

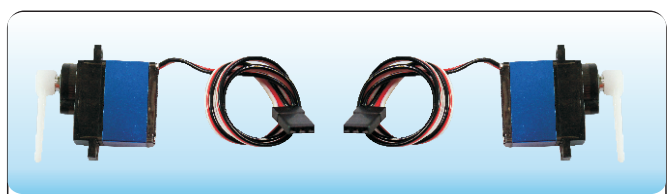

HSD-F-13

TROUBLE SHOOTING

| Problem | Cause | Solution |
|--|--|--|
| Motor does not turn | <ol style="list-style-type: none"> 1. Battery is not fully charged 2. Transmitter battery low 3. Motors not connected 4. The motor is damaged 5. Receiver is not bound to Tx 6. ESC in set-up mode | <ol style="list-style-type: none"> 1. Charge the batteries 2. Install a full charged battery 3. Check for connection between the ESC and motor. 4. Replace motor 5. Consult Radio manual and go through bind procedure again 6. Hold model and move throttle to full position then back down to idle |
| Model moves backwards | <ol style="list-style-type: none"> 1. Both ESC and motor are not establishing a proper response range | <ol style="list-style-type: none"> 1. Locate the three (3) connections between the motor and ESC, disconnect two (2) of the three (3) and swap their places for proper response |
| Control Surfaces are not responding to stick input | <ol style="list-style-type: none"> 1. The servo lead may be connected to the receiver incorrectly 2. The servo is damaged | <ol style="list-style-type: none"> 1. Make sure the servo leads are properly connected to the receiver 2. Replace the servo |
| Model is flying erratically | <ol style="list-style-type: none"> 1. The control surfaces are not centered 2. The control surfaces are severely off center 3. Center of Gravity (CG) is not in the correct position. | <ol style="list-style-type: none"> 1. Make trim adjustments as necessary on the transmitter if the issue is not serious 2. Make manual adjustments as necessary to the surface control linkages 3. Re-position the Li-Po battery as necessary to achieve a balanced CG. |
| Model does not climb well | <ol style="list-style-type: none"> 1. The battery is not fully charged 2. Elevator surface response is reversed 3. CG is too far back causing a tail heavy airframe | <ol style="list-style-type: none"> 1. Re-charge the battery within the specified charge time 2. Charge the surface direction via the 'reverse' function on the transmitter 3. Re-position the Li-Po battery as necessary to achieve a balanced CG |
| Limited Radio Range | <ol style="list-style-type: none"> 1. Transmitter or receiver (if applicable) power is low | <ol style="list-style-type: none"> 1. Charge or replace any batteries used on the transmitter and receiver (if applicable) |

MODEL FLYING PRECAUTIONS

- Select your flight area carefully. Always choose an open space that is unobstructed from trees and buildings and away from crowded areas. Avoid flying in areas with roads, electric/telephone poles/wires and water near by or within close proximity to full size air traffic.
- Do not fly this model in poor weather. High winds, low visibility, inclement temperatures, rain and storms are to be avoided.
- Never attempt to catch this model whilst in flight. Even a slow moving model can cause harm to yourself and/others and risks damage to the model.
- This model is recommended for children no younger than 14 years old. All children, no matter what age, should always be supervised by a capable and responsible adult when operating this model.
- Always unplug your model battery when not in use. Never leave the battery installed in the model.
- Please remember to keep clear of the propeller at all times when your flight battery is connected.
- Before flying, always turn on your transmitter first then plug your flight battery into the model.
- After flying, always unplug your battery first then turn off your radio transmitter.
- Exercise caution when charging your batteries and follow in full your battery manufacturers safety guideline when doing so.

PRE-FLIGHT CHECKS

1. Always range check your model before any flight (especially when flying a new model for the first time). Follow your radio manufacturers guidelines for performing this check.
2. Check all screw/bolts and mounting points are firmly secured, including control horns and clevises.
3. Only fly with fully charged batteries (both in your radio and model). Failure to do so could result in loss of control, damage to the model and/or persons/property around you. Check your batteries are fully charged.
4. With the model powered up (Transmitter on first, then receiver/model) check that all surfaces are free from damage/obstructions, moving in the correct directions and freely with stick input.
5. Inspect the model and prop for any damage that may have occurred during transit and listen for any unusual sounds from the electronics when powered up. If in doubt, do not fly.
6. If this is your first flight with the model double check the CG is at the correct position. If not adjust battery position inside model accordingly.
7. If you are an inexperienced model pilot seek the help and assistance of an experienced pilot to perform these final checks and to test fly the model for you.

Furious 200



www.hsdhobby.com