

产品仅适合14岁以上儿童使用  
Not suitable for children under 14 years old

A



NO.3838-1

1:16 SCALE 2.4GHz RC Main Battle Tank

# U.S.M26 PERSHING

使用说明书  
INSTRUCTION MANUAL

7.0



- ◆ 启动熄火装置  
ENGINE START/OFF DEVICE

---

- ◆ 全比例遥控  
FULL SCALE R/C FUNCTION

---

- ◆ 仿真冒烟可开关控制  
THE SIMULATED SMOKE EFFECT CAN BE SWITCH ON/OFF

---

- ◆ 仿真发动机启动声、发动机声、机关枪声、炮声、带仿真动作声音可以调节、音效模式切换  
SIMULATIVE ENGINE START-UP SOUND, ENGINE SOUND,  
MACHINE-GUN SOUND, FIRED SOUND, EMULATIONAL ACTION  
WITH ADJUSTIVE VOLUME AND SWITCHABLE SOUND EFFECTS.

---

- ◆ 红外线对战功能  
Infrared battle function



● 使用前详阅本说明书  
PLEASE READ THROUGH THIS MANUAL BEFORE USE.

<http://www.hl1986.com>

## 警告(Warning):

本产品含有小零件请勿让三岁以下儿童玩耍；本品含电气元件，不得入水或在潮湿环境下使用；请勿折断遥控天线，以免造成伤害；电池充电器应定期检查其电线、插头、外壳和其他部件是否损坏，发现损坏时应停止使用，直至修复完好。

Choking hazard! This product contains small parts. NOT suitable for children under 3 years.

Contains electrical components and should be kept dry at all times.

To avoid any possible injury DO NOT use if the antenna is broken.

Regularly check the battery charger wires, plugs and shell and other components for damage.

DO NOT use if any part is damaged.

Replace any damaged components before reusing.

## 注意事项 (Caution proceeding)

- 1、可拆卸的小零件要放好，千万不可让小孩吞食。
- 2、如操作场地有电波干扰，请另选场地操作。
- 3、遥控器电源低电时，请立即停止操作。
- 4、对拆除后的包装物，请不要随地丢弃，以免污染环境。
- 5、请将你的遥控模型存放在干燥、阴凉的地方。
- 6、不要置于近火和高温、潮湿的地方储存。
- 7、当电池被水浸湿，请将水分充分地擦拭干净。

1. Detachable small parts should be stored safely and out of reach of children.
2. If interference is experienced, turn the tank off and try it again in a different area.
3. Remote control will not function correctly if the batteries are low. Please replace the batteries.
4. Please discard old/used batteries in a safe manner. Consider your environment.
5. Please store the remote control in cool, dry place.
6. DO NOT expose to fire or high temperatures, moist storage.
7. Should the battery get wet, wipe immediately with a soft dry cloth.

### 电池使用注意事项(Battery use caution proceeding)

- 1、车体使用一组 7.2V / 7.4V 可充电电池组；
- 2、安装或更换电池时请注意极性；
- 3、充电电池只能在成人监护下充电，且须用本产品所配套的充电器充电，否则会有危险；
- 4、不可混用新旧或不同型号的电池；
- 5、从模型内取出用尽的电池；
- 6、电源端子不应短路；
- 7、非充电电池不可充电；
- 8、充电电池充电前应从模型中取出；
- 9、请不要将坏的电池、电池组分解或扔到火中、水里，以免发生意外；
- 10、充电器的额定输入电压必须与当地的家用电压相符；
- 11、在充电过程中，充电器和电池出现微温，属于正常现象。

1. Main Tank body uses a set of 7.2V / 7.4V rechargeable batteries;
2. Please pay attention to correct polarity when replacing batteries;
3. Rechargeable batteries should be charged under adult supervision, and must be used with this product matching charger to charge, otherwise there will be danger;
4. DO NOT use a mix of old and new or different types of battery;
5. Low, or exhausted batteries should be removed from the unit;
6. DO NOT short circuit any terminals;
7. DO NOT attempt to recharge non rechargeable batteries;
8. Remove batteries from the unit when recharging;
9. DO NOT put batteries into a fire or into water;
10. The rated input voltage battery charger MUST be suitable for your mains power voltage;
11. During charging it is quite normal for the charger and batteries to heat up.



### 注意：(使用说明书) 使用前详阅本说明书

Cautions: (Operating Instructions) Please read through this manual before use.

这辆RC (遥控)战车坦克是由无线电控制的模型, 而非玩具, 装在车内的电动炮和塑料BB弹可发射20-30m, 要小心使用, 否则会误伤, 请详阅下列各点, 理解透彻后再作游戏。

This RC (remote controlled) battle tank is not a toy but a tank model controlled with radio signals. It's motor air gun and plastic BB bullets are very powerful with a shooting range of 20 to 30m. Please use carefully to avoid hurts. Please read through the following cautions before use.

坦克装有炮弹, 不小心发射或错误使用都会有危险! This tank has a built-in motor air gun. Use carefully to avoid hurts by accidental shooting or misuse!

#### 请戴上护目镜

Please have goggles on.



在发射子弹时, 本人和周围的人都应戴上护目镜。如果子弹碰到硬物, 会弹回伤害到人, 要小心。(也要注意勿伤他人)  
All people in the spot should have goggles on when shooting, please note that the bullet may rebound when it hits something hard. (make sure no passerby will be hurt.)

#### 控制后把主开关置“OFF”

Set the main switch to OFF after playing.

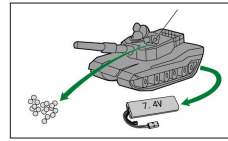

①把BB炮弹取出 (翻转车身, 把炮弹取出)  
②拆下电池 (否则由于自然放电会引起漏液)。  
①Remove the BB bullets. (Turn the tank upside down and pour out the BB bullets.)  
②Remove the batteries. (Otherwise, the batteries may discharge by themselves and cause leakage.)

#### 不可朝人和动物发射

Do not shoot at people or animals.

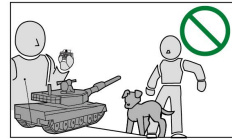

不可让坦克瞄准人和动物发射, 否则可能以伤害罪被处罚。  
Do not aim the gun at or shoot at people or animals. Otherwise, you may possibly be punished for bodily injury.

#### 任何时候都不可窥视发射口

Never look into the gun muzzle.

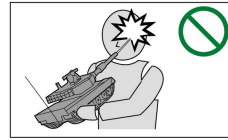

不管里面是否有炮弹, 不可窥视发射口, 以免伤到眼睛, 如无线电波不佳时, 由于误操作可能会发射出来, 非常危险。  
To protect your eyes, never try to look into the gun muzzle, whether there is bullet inside or not. Please also note that accidental shooting may be triggered when the radio signal is poor.

#### 不可在马路等有汽车的地方行走

Do not play the tank on the roads.



为避免交通事故, 不可在马路行走, 也不要在水洼地、砂地等难以行走之处玩, 以免发生故障。  
Do not play on the roads to avoid traffic accidents. Besides, do not play on water pit, sands, or carpet to avoid malfunction of the tank.

#### 不可在人和汽车横过的地方发射

Never shoot in a place where there are people or cars passing by.

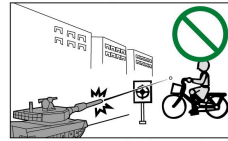

在这些场所发射有可能意外伤到人, 决不可发射。  
If there are other people or cars passing by, shooting may cause danger to them. Do not shoot in such places.

#### 防止小儿误吞零件

Prevent part swallowing by little children.



不可把小零件和塑料袋给小儿玩, 以免误吞。  
Do not give small parts or the plastic bag to little children to avoid accidental swallowing.

#### 不可把手伸入车轮和履带

Do not put hands into the wheels or the caterpillars.

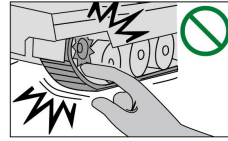

不可把手伸入车轮或履带以免误伤, 小孩需特别小心, 当拿坦克时不可拿住车轮以免由于误操作而受伤害。  
Do not put the hands into the wheels or the caterpillars to avoid hurts. Do not touch the wheels or the caterpillars when holding the tank to avoid hurts by misoperation.

#### 不可把天线乱挥舞或把脸靠近它

Do not wave the antenna about or get the face too close to it.

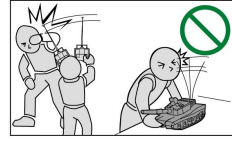

若天线尖端碰到眼睛, 可能引起误伤, 切不可乱挥舞或把脸靠近它, 折断的天线非常锋利, 很危险, 所以需到本公司的售后服务部更换。(需付款)  
The end of the antenna is dangerous to the eyes. Do not wave the antenna around or get the face too close to it. Besides, if the antenna breaks, the sharp end may be extremely dangerous, please refer to the after-sales service center for replacement. (Optional)



### 注意 错误使用, 改造和分解而造成的伤害、事故, 本公司概不负责, 且不负责改造、分解后商品的修理。

The company will not be responsible for any hurt or accident caused by user's misuse, alteration or disassembly of the product. And we will not repair products that have been altered or disassembled by the user.

- 不可把发射口对准容易损坏的物品 (如玻璃、灯、家用电器、餐具、家具等)。
- 除了本公司指定的BB弹以外, 其他子弹容易造成堵塞, 不可使用。投入和发射口不可放入BB弹以外的其他物品。
- 使用说明书妥善保管好, 丢失时向本公司订购。
- 不可强行分解和改造, 否则会造成故障和危险, 绝对不可以。
- 坦克和遥控器浸入水中或弄湿时可能会出现故障, 这时要禁止使用, 并拆下电池, 与本公司的售后服务部联系。
- 不可把坦克和遥控器置于阳光强烈照射处, 否则会发生变形和误操作。
- Do not point the gun muzzle at fragile or other easily breakable articles, such as glass, lamp, electric appliance, tableware, or furniture.
- Bullets other than the specified BB bullets may easily cause blockage. Do not put any other bullets or other articles into the bullet hatch or the gun muzzle.
- Keep the manual properly, if it is lost, please contact us for a mail order.
- Never try to disassemble or alter the product to avoid malfunction or danger.
- Because malfunction may be caused when the tank or the remote controller is immersed in the water or gets wetted, stop using immediately and remove all batteries and contact our after-sales service center.
- Do not expose the tank or the remote controller to strong sunlight. Otherwise, they may be deformed or cannot function correctly.

# 使用说明书 RC Battle Tank Operating Instructions

## 警告 Warning

若无视里面的警告，自行进行错误操作，会发生误伤和诱发故障。绝对要遵守各注意事项。

## 注意 Caution

Hurts or malfunctions may be caused if the cautions are neglected. Please abide by all requirements.

**注意 Caution:** 本战车用于室内竞技，在户外时不可在下述场景使用。  
This battle tank is for indoor use only! Please avoid the following misuses.

该战车制作精密，需小心，不可乱碰撞；不可让灰尘、小石等侵入车子内部和齿轮。(遥控器也同样) (否则即使在保修期间也由顾客负担！)  
This tank is a precisely-made product and should be used with care. Avoid bumping or dust or sand or stone entering the body or the wheels.  
(The same requirements for the remote controller) (Otherwise, all related expenditure would be born by the user!)



车子跌落、碰撞等强烈的冲击会造成故障。  
Violent shocks caused by fall or bump may lead to malfunction.



不可在有积水的地方行走(遥控器也不可弄湿)  
Do not play the tank in a place where it could easily get wetted.  
(The remote controller should also be kept dry.)



户外的砂地、凹凸不平处，灰尘多的地方也不可行走。  
Do not play the tank on sands or other uneven surfaces or in a place with too much dust.



不可在草地、沼泽地等阻力大的地方行走。  
Do not play the tank on lawn or other places that may cause excessive resistance.



投入口不可装入指定BB弹以外的物品。  
Do not put articles other than the specified BB bullets into the bullet hatch.

## 注意 Caution

使用工具时注意安全  
Keep yourself safe when using tools.

- 需另购的物品(遥控器电池)  
Articles to be purchased (controller's batteries)
- AA电池6粒(用于遥控器)  
6x AA Batteries (For controller)

## 电池的注意事项。 Battery-related caution.

不可使用破损电池，以免发生短路危险。  
Do not use broken batteries to avoid short circuit.

发射时戴上护眼镜，确保安全。  
Please wear goggles to ensure safe play.



## 套件内容 Set content

**注意** 安装附属零件前要检查是否正确操作(见3P 4P 5P 6P 7P)  
Caution: Check to make sure the tank functions correctly before installation of the accessories. (See P3, P4, P5, P6, P7)

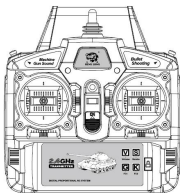

遥控器  
Remote controller



贴纸 Paster



配件盒(包括自装配件等)  
ACCESSORY BOX(The onself accessory is included)

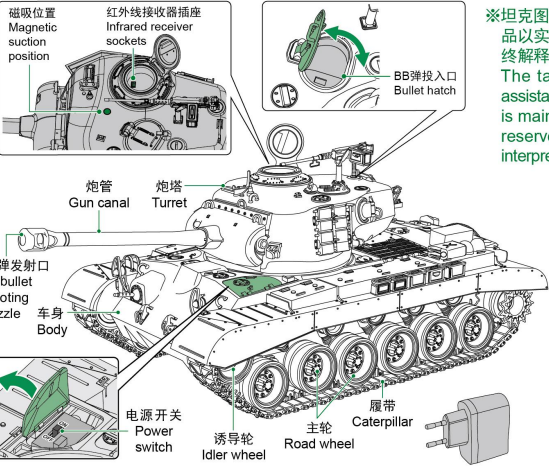

磁吸位置  
Magnetic suction position

红外线接收插座  
Infrared receiver sockets

BB弹发射口  
BB bullet shooting muzzle

车身  
Body

炮管  
Gun canal

炮塔  
Turret

电源开关  
Power switch

诱导轮  
Idler wheel

主轮  
Road wheel

履带  
Caterpillar

※坦克图示仅供协助说明，产品以实物为主，本厂保留最终解释权。  
The tank diagram is for assistance only. The product is mainly in kind. Factory reserves the right of final interpretation.

BB弹发射专用  
Special for BB shoot

BB弹 BB bullet



靶子 Target



USB 变压器(选购)  
USB Transformer  
(Additional purchase)

7.4V 充电电池组  
7.4V Rechargeable batteries

7.4V USB 充电线(专用)  
7.4V USB Charge line(Special)

红外线接收器  
Infrared receiver

## 敬告 (Warning)

尊敬的用户：

本产品是配置一种环保节能的锂电池作为供电电源，请您在使用中严格遵守使用规则，这样你的锂电池才能正常使用。

1. 首次使用锂电池组时须先充满电再使用。
2. 每次使用后（不论使用时间长短）都应取出电池重新充电，保持电池处于带电状态。
3. 当使用电池达到电量极限时，须尽快充电，如在电池过放电情况下，搁置不充，会严重损伤电池的寿命及性能或导致电池永久性损坏。
4. 电池组不能使用处于极热环境中，如阳光直射或热天的车内，否则，电池组过热，这样就会影响性能、缩短电池组的使用寿命。
5. 环境温度会影响放电容量，环境温度超标准环境时（ $25^{\circ}\text{C}\pm 5^{\circ}\text{C}$ ），放电容量会有所降低。
6. 电池组在充放电过程中，如果出现异味、异常声响，请立即停止充电或放电。

Dear users:

This product is equipped with an eco-friendly and energy-saving lithium battery as the power supply. Please strictly abide by the instructions while using it, so that your lithium battery can work normally.

1. Before the first use, the lithium batteries must be fully charged.
2. The battery should be recharged after each use (no matter how long it was used) to keep the battery charged.
3. When the battery is about to run out, it should be recharged as soon as possible. If the battery is not recharged in case of over-discharge, the battery cycle life and performance will be seriously damaged or the battery will be permanently damaged.
4. Batteries cannot be used in extremely hot environments, such as under direct sun light or in a car in hot weather. Otherwise, the overheated batteries will affect the performance and shorten the cycle life.
5. Ambient temperature will affect the capacity of electric discharge. When ambient temperature exceeds the standard environment ( $25^{\circ}\text{C}\pm 5^{\circ}\text{C}$ ), the capacity of electric discharge will decrease.
6. During the charging and discharging of the batteries, if an abnormal odor or sound appears, please stop the charging or discharging immediately.

## 电池使用注意事项 (Caution)

1. 电池充电时，务必使用本套材内专用的USB充电线，以免造成危险！
2. 请小心维护电池，按标准充电时间为电池充电，以延长使用寿命，避免不当使用而造成电池损坏。
3. 勿将正负极接反！勿将电池组投入水中或将其弄湿！
4. 禁止在火源或极热条件下给电池组充电！勿在热源(如火或加热器)附近使用或贮存电池组！如果电池泄漏或发出异味，应立即将其从接近明火处移开。第一次使用电池，需将电池充满电后再使用。
5. 勿将电池组投入火中或给电池组加热！
6. 禁止用导线或其他金属物体将电池组正负极短路！
7. 禁止用钉子或其他尖锐物体刺穿电池组壳体，禁止锤击或脚踏电池组！
8. 禁止以任何方式分解电池组和电池！
9. 禁止将电池组置于微波炉或压力容器！

1. When the battery is getting charged, please use the special USB cable of this material to avoid danger!
2. Please take good care of the battery pack. Before charging. Please charge the battery pack according to standard charging time to prolong its service life, avoid damage of battery caused by improper use.
3. Do not reversely connect the positive and negative poles! Do not put the battery pack into the water or wet them!
4. Do not charge the battery pack under fire or extremely hot environment! Do not use or store battery pack near heat sources, such as fire or heaters! If the battery leaks or smells, please remove it immediately from the place that is close to the open fire. Before the first use, the battery should be fully charged.
5. Do not put the battery pack into the fire or heat them!
6. Do not use wires or other metal objects to short-circuit the positive and negative poles of the battery pack!
7. Do not use nails or other sharp objects to pierce the battery pack shell; do not hammer or pedal the battery pack!
8. Do not disassemble the battery pack or the battery in any way!
9. Do not put battery pack in microwave ovens or pressure vessels!

安装零件前务必检查是否正确操作 Check to make sure the tank functions correctly before installation of the accessories.

万一无法正确操作，请联系售后服务部或所购买的商店。  
If you find the tank cannot function properly, please contact our after-sales service center or the shop that sold it to you.

**注意** 装上了零件的商品不能更换，这时被认作是修理。  
It may be difficult for us to replace for the user a tank that has already been installed with the accessories. Only repair service will be available for such request.

**警告 Warning**

若电池正负极接反，会引起漏液和故障，要小心。  
If the battery connection is made the opposite, battery leakage or device malfunction may be caused.

**充电：平衡充电器(选购)**  
Charging: Balance charger charging(Additional purchase)



- ※双插头电池：无内置智能保护板  
Two-plugs battery: No intelligent protective board
1. 将充电器插头插入电源插座，这时充电器上的绿灯(电源/充电指示灯)亮起。再将充电器电源输出插头连接到充电电池接头，此时充电器上的绿灯变成红灯，表示正在充电。当充电器上的红灯变成绿灯时，则表示充电电池电量已充满，此时充电结束。充电时间大约为2小时。
  2. 充电完毕，把充电器插头拔出。
- ① Will charger plug insert Power socket, then the green light on the charger (power/charge indicator) light. Again will charger power output connector to connect to the rechargeable battery when. At this time the green light on the charger into become the red light. When the red light on the charger into a green light indicates that power has been full of rechargeable batteries, charging the end of this time. The charge time is about 2 hours.
- ② Disconnect the charger plug after the charge.

**注意 Caution:**

1. 充电器的额定输入电压必须与当地的家用电压相符；
  2. 充电时，充电器和电池会微热属正常；
  3. 在插入或拔出充电器时，要注意手指不能接触到充电器的端子；
  4. 插头连接时，务必认清正负极。
- ① The rated input voltage battery charger with the home must be in line voltage;
- ② When charging, it is normal that the transformer and the battery may get mild heat;
- ③ During the insertion or removal of transformer, please pay attention that the finger should not be contacted to the end of the transformer;
- ④ The plug connection, must recognize the positive and negative pole.

**1 充电：USB充电线充电(标配)**  
CHARGING: USB CHARGER LINE CHARGING (STANDARD)

- ① 将USB充电线插入电脑的USB接口(如图)，或插入手机充电器的USB接口(如图)，此时USB充电线电源指示灯红灯亮起。
  - ② 再把电池的插头与USB充电线的充电插头按正确极性对接(如图)，此时USB充电线充电指示灯绿色灯闪烁，进入充电状态，约4小时后充电指示灯绿色灯变为长亮，红灯熄灭，此时充电完成。
- ① Insert the USB cable into the USB socket of the computer or plug into the cell phone charger USB socket (as shown) At this time, the indicator of the USB cable red light is on.
- ② Connect the battery plug with the USB charging plug according to the correct polarity (as shown). At this time, the green light of USB charging indicator start flashing. This is the charging state. About 4 hours later, the green charging indicator will turn on from flashing, red light is off, charging completed.

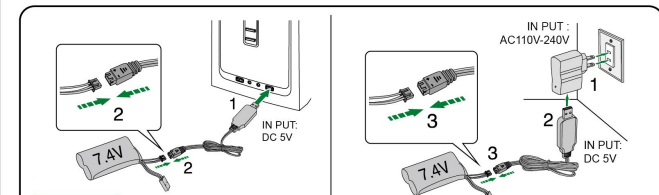

**警告 Warning**

1. 本电池内置智能保护板；
  2. 本USB充电线为本产品中的7.4V带保护板锂电池专用的，严禁为其它任何电池充电，否则造成危险，后果自负！
- ① Built-in battery intelligent protective board.
- ② This USB charging wire is special for 7.4V lithium batteries with protective plate. It is forbidden to charge any other batteries, otherwise it will cause danger and the company won't bear the consequences.

**2 电池(车体)**  
BATTERY (TANK)

- ① 用螺丝批拧开螺丝钉，打开电池盖。  
Undo the screw with the screwdriver, and open the battery cover.

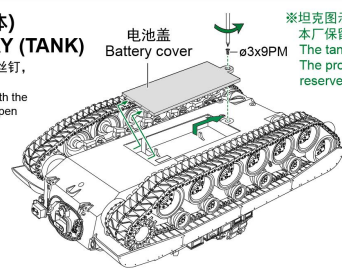

- ② 装入电池。  
Load in the battery.

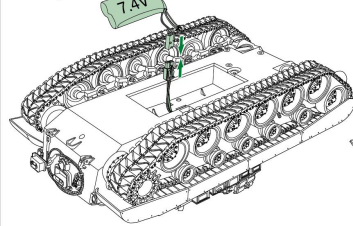

- ③ 把爪子对准插好，将电池盖安装好，拧紧螺丝钉。  
Insert the claws properly to replace the cover, assemble the battery cover, tighten the screw.

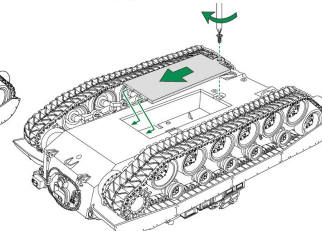

※坦克图示仅供协助说明，产品以实物为主，本厂保留最终解释权。  
The tank diagram is for assistance only. The product is mainly in kind. Factory reserves the right of final interpretation.

### 注意 Caution

●使用过的BB弹沾上了灰尘，不可再用。  
Once shot out, the BB bullet becomes dirty and not suitable for reuse.



●若BB弹附有灰尘和砂子，可能会堵塞弹道，并导致内部故障。  
If BB bullets with dirt or tiny sand on are used in the gun, the gun barrel may easily be blocked and the inner mechanism may be damaged.

●不可强行装入子弹，否则会发生故障。  
Improper loading of bullets may lead to malfunction.

●使用0.2g以上的重弹时，子弹飞得不会太远。  
If the bullets used weigh over 0.2g, they won't be shot far enough.

### 如果子弹堵塞

If the bullet jam  
如果弹匣中进入灰尘等，BB弹的流动不会顺畅，无法很好地发射，甚至会引起子弹堵塞。出现这种情况时要立即停止发射，把弹匣朝下轻轻摇动战车，把BB弹和灰尘倒出来，甚至可以把炮塔盖拆下，从间隙吹入气体把灰尘吹出来后再装入BB弹。

If dirt or dust gets into the bullet hatch, the rolling of the bullets may be disturbed, making shooting difficult or even impossible. In such circumstances, turn the tank up side down for the bullet hatch to face down and slightly shake for the dirt or dust to fall out. If necessary, you can also remove the cover of the turret and blow into the gap to clean up the dirt before loading in bullets.

### 3 BB弹的装填 HOW TO LOAD BB BULLETS

① 打开BB弹投入口，约投入100颗BB弹。

Open the bullet hatch and put in about 100 BB bullets.

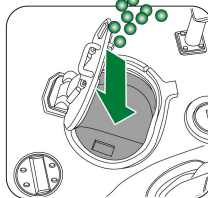
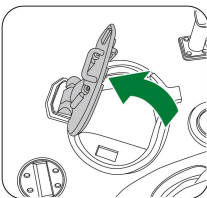

② 关闭BB弹投入口

Close the bullet hatch.

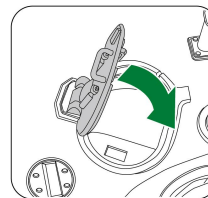

使用下列不良炮弹会损坏内部机件  
Use of the following bad bullets may lead to internal damages.



超过6mm直径的BB  
BB of a diameter over 6mm



偏心的BB  
Eccentric BB



有凸部的BB  
BB of uneven surface

※弹道改良系统的说明  
※briefing of hop-up system

■如下图所示，飞行距离大幅度提高  
Flying distance becomes much longer, as the picture shows.

○ 弹道改良系统的弹道 Ballistic trajectory with hop-up system

○ 没有弹道改良系统的弹道  
Ballistic trajectory without hop-up system

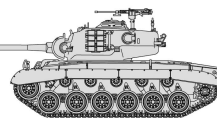

RC坦克上带有弹道改良系统

The RC tank is equipped with hop-up system.

这个系统通过一定的空气压力，在发射出去的BB弹上加上强烈的后旋转，这样就产生上升力使子弹尽量向远方发射。Influenced by the system, the shot out BB bullet will forcefully spin back while running forward at high speed, generating climbing power to go further ahead.

### 4 红外线接收器安装方法 INFRARED RECEIVER INSTALLING METHOD

如下图，购买2辆或以上带有红外线对战系统的坦克并按图示方法，将红外线接收器插头按正确方向连接到坦克炮台上指定的插座上，同时也将红外线接收器固定到指定的磁吸位置上。

As shown, Purchase more than two pieces infrared battle system tanks. Connect the infrared receiver's plug in the specified sockets on the turret. Also put the infrared receiver to the specified magnetic suction position in the same time.

第二步：把红外线接收器固定在磁吸位置上

Step 2: Put the infrared receiver to the specified magnetic suction position

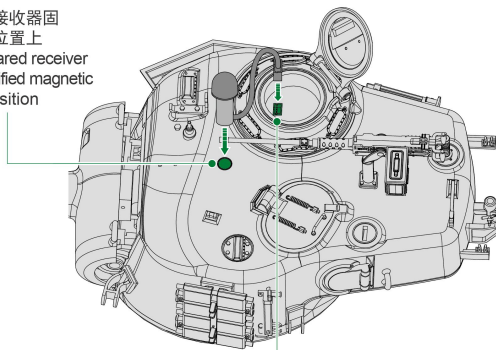

第一步：把红外线接收器插头按正确极性插入插座中  
Step 1: Connect the infrared receiver's plug in the specified sockets

## 5 附属零件的安装 HOW TO INSTALL ACCESSORIES

### ● 附属零件清单 PARTS LIST

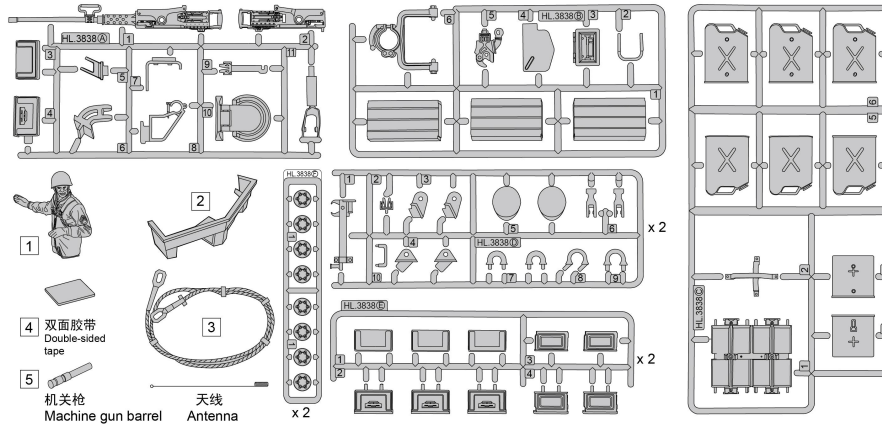

### ● 附属零件的安装 HOW TO INSTALL APPENDANT PARTS

#### ⚠ 注意 Caution

安装自装部件时，若部件孔位太过松动请自行用瞬间粘着剂粘合；若部件孔位狭窄，请自行用工具处理。  
DIY installation components, if the hole is too loose parts split second binding your own; if a narrow hole parts, dealing with your own tools.

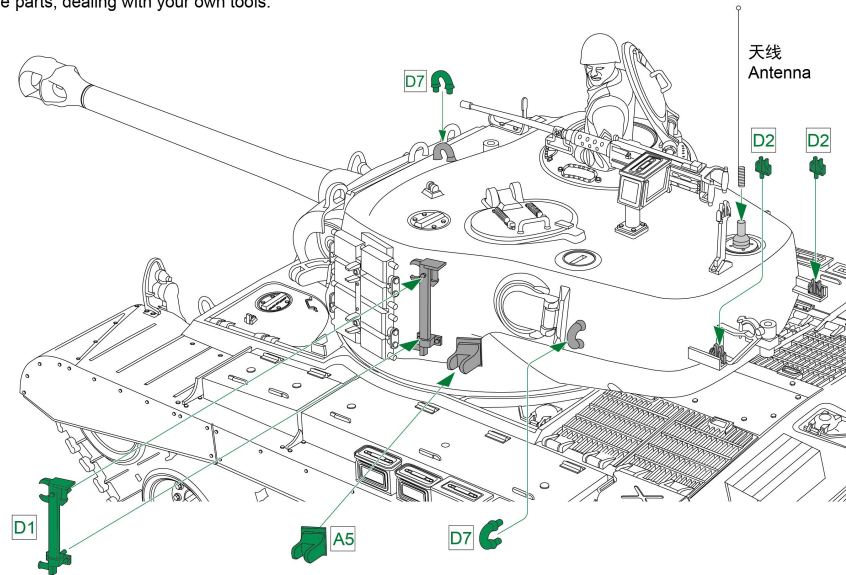

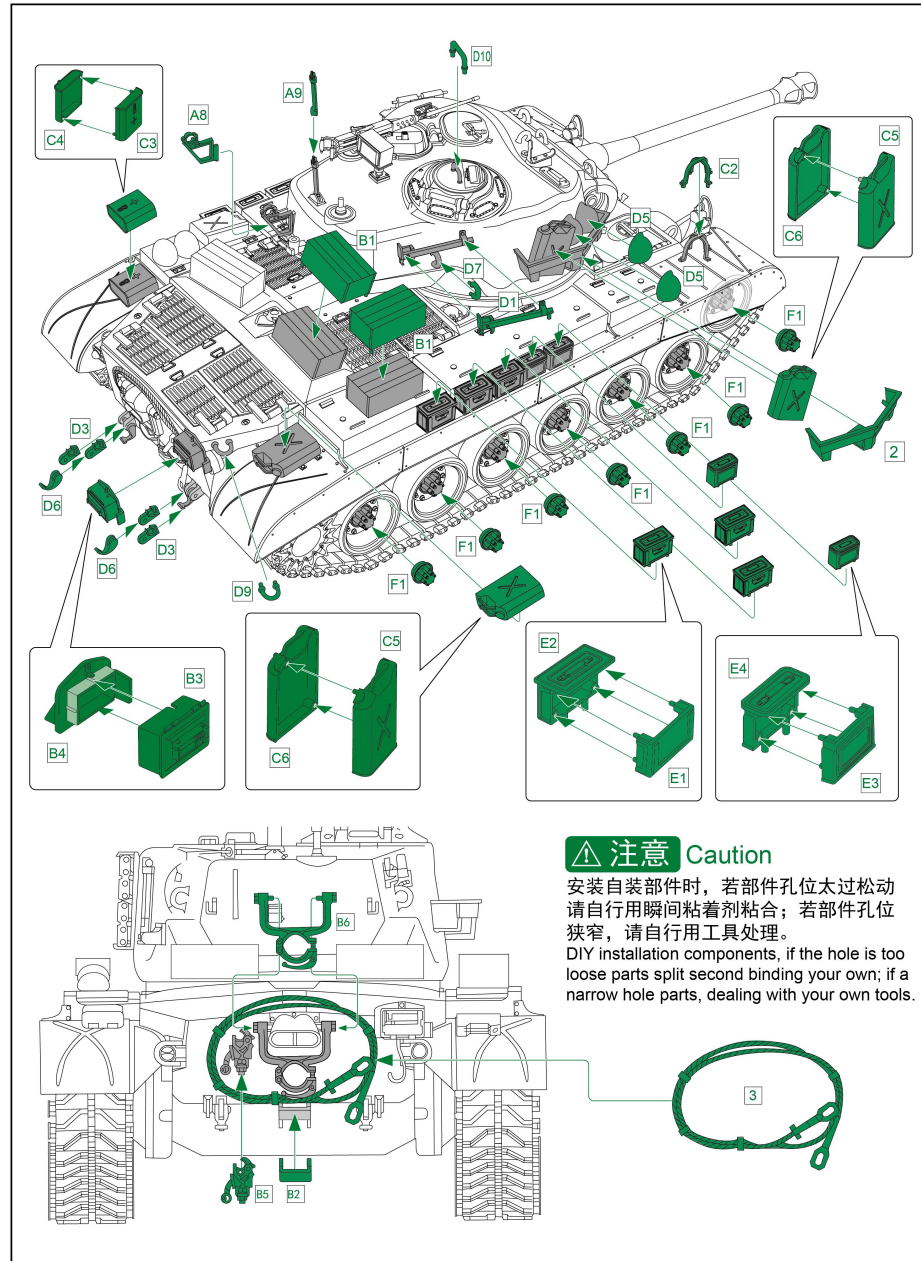



## 6 部队番号贴纸的贴法 HOW TO STICK MARK SEALS

1. 先将要贴的标志用剪刀从贴纸中剪出来，然后撕去底纸。  
The first sign to be posted from the sticker with scissors out, then ripped the end of paper .



2. 把标志贴到所需的位置，然后再从贴纸的一边到另一边用手的拇指均匀地紧压，让标志充分紧贴。  
Stick the mark to you need the position , and then from side to side sticker hand thumb pressed evenly , so close to the full mark.

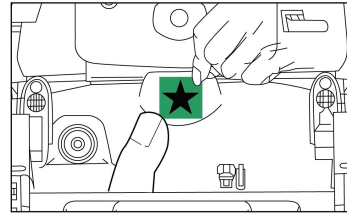

3. 待十五分钟后，再撕下透明膜。  
After wait for 15 minutes, then tears down the transparent film.

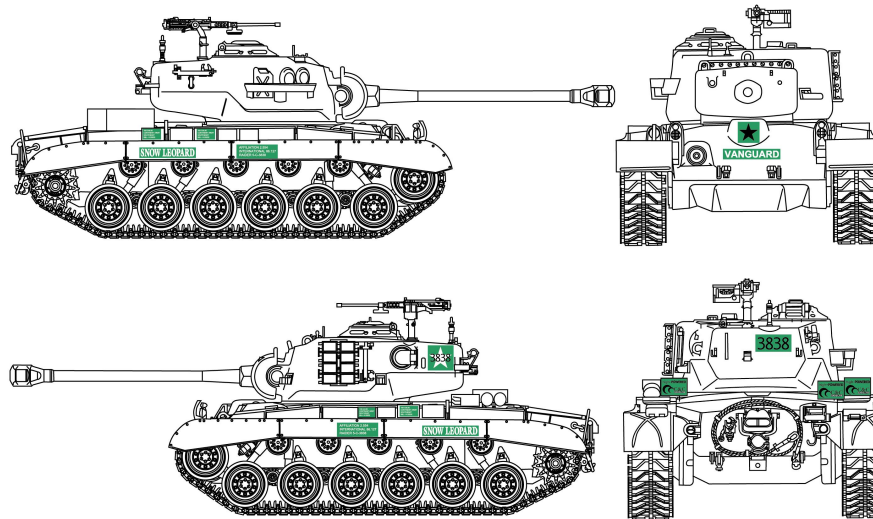
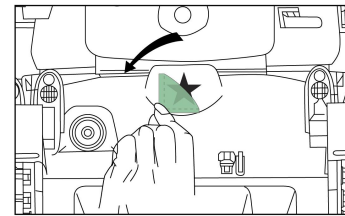

图示所贴贴纸，为产品原贴法，其它贴纸供使用者随意装饰。

As shown, the pasters are according to originally product stick method, however, other pasters decorates at will for the user.

## 冒烟装置的使用方法 OPERATING INSTRUCTIONS ABOUT SMOKING SET

本坦克车出厂时，已添进少许烟雾剂。在第一次使用前，不须添加烟雾剂。可以使用时间约1小时左右。(但有时使用不到1小时，闻有烧焦味时。这表示烟雾剂快使用完，必须马上添加烟雾剂，否则会损坏冒烟装置。)以后每次使用累计超过1小时，都必须再添加2毫升烟雾剂。

There is litter aerosol in tank at factory. Need not to increase aerosol for the first time use, the aerosol can use about 1 hours. (This indicates the aerosol have exhaust when you smell single smell within 1 hours. So you must add the aerosol to avoid malfunction of the smoking set). You must add 2 ml aerosol. Aerosol for use about 1 hours every time except the first time use.

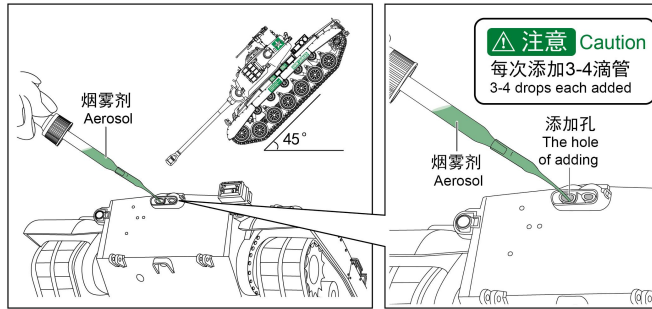

### 注意事项 Cautions

- 添加烟雾剂时，必须把坦克尾部抬高45度左右，添加后并停留片刻，使坦克烟雾剂可以流向中部烟雾装置。
- 当电池低电时，冒烟效果将不明显或失效，应及时为电池组充电；
- 当电池足电时，发现烟量减少应及时添加烟雾剂，以防损坏冒烟装置。

- Add aerosol, it is important to raise the rear of the tank around 45 degrees, and stay a while after adding to the flow of the central tank can smoke aerosol device.
- When it's low battery. The smoke is not obvious or stop working, Should charge the battery immediately.
- When the battery is enough. Please refill the smoking oil when the smoke is getting thinner, To prevent the damage of the smoking system.

### 修理时须知：以下情况即使是保修期间也要付款

Note: Repair services to damages caused by the following reasons are to be charged, whether within the term of quality guarantee or not.



掉落、强烈撞击造成的故障。  
Accidental fall or strong bump, which leads to tank or controller damages.



在积水和潮湿处行走，被水弄湿(包括遥控器)造成的故障。  
The tank (or the remote controller) is wetted when running in a wet place, which leads to malfunctions or breaks.



在户外泥地沙地、凹凸不平处、灰尘多之处行走造成的故障。  
The tank runs in a place with too much sand, mud, dirt, or on an even surface, which leads to malfunctions or breaks.



在地毯、草地等阻力大的地方行走而造成的故障。  
The tank runs on carpet, lawn or other places with excessive resistance, which leads to malfunctions or breaks.



在BB弹投入口放入指定BB弹以外物品而堵塞造成的故障。  
Articles other than the specified BB bullets are put into the bullet hatch, which leads to inner blockage.



使用过的BB弹因为附上灰尘，绝对不可再使用以免造成故障。  
Dirty or used BB bullets or other bullets are used in the tank, which leads to malfunction or breaks.

使用污染的BB弹，用过的BB弹和指定以外的BB弹而造成的故障。  
BB bullets that have been used may get dirt on them and cannot be reused to avoid damages to the tank.

7 没有遵守说明书上的警告和注意事项而造成的故障。  
Other malfunctions due to violation of warnings or cautions described in this manual.

8 错误使用而造成的故障。(电池接反，弄湿，碰撞等)  
Malfunctions due to misuses (reverse battery connection, wetted parts, or bumps).

9 不当的分解和改造而造成的故障，或使用本公司以外的零件。  
Malfunctions due to improper assembly or restructuring or use of unspecified parts.

10 购买后由于输送，掉落造成的故障，或保管不周。  
Malfunctions caused during moving or by falls or by poor storage condition.

11 使用所指定以外的电池造成的故障，强行在阻力大的地方行走而损伤主板和马达。  
Malfunctions caused by use of unspecified batteries. Chassis or motor damages caused by running over places with excessive resistance.

12 其它保证规定之外的故障和损伤。  
Other malfunctions or breaks not within the range of our quality guarantee.

※改造或分解的商品不受理维修。

※The manufacturer does not offer repair services for commodities restructured or disassembled by the user.

## 电气零件表 (ELECTRONIC PARTS)

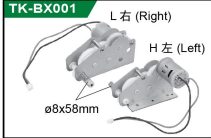

TK-BX001 L 右 (Right)  
H 左 (Left)  
ø8x56mm  
驱动波箱(塑胶齿轮)  
Drive gearbox ( plastic gear )



TK-BX002  
打弹波箱  
(Airsoft) Shooting unit #1



TK-BX007A  
升降波箱3  
Gun barrel elevation unit # 3



TK-BX008A  
转向波箱  
Steering gearbox  
V: 6.0

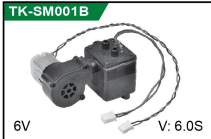

TK-SM001B  
冒烟波箱  
Smoke generator  
6V  
V: 6.0S



TK-SP004  
双体音箱1(高音质)  
Double body speaker unit # 1  
(High timbre)  
V: 6.0



TK-SP005  
双体音箱2(高音质)  
Double body speaker unit # 2  
(High timbre)  
V: 6.1



TK-EC001F  
7.0功能主板(2.4GHz)  
7.0 Multi-function circuit unit(2.4GHz)  
V: 7.0

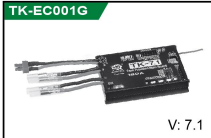

TK-EC001G  
7.1 功能主板(2.4GHz)  
7.1 Multi-function circuit  
unit(2.4GHz)  
V: 7.1

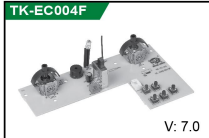

TK-EC004F  
7.0发射板(2.4GHz)  
7.0 Transmitting board (2.4GHz)  
V: 7.0



TK-EC008  
大六脚开关(SS-22H03 G7)  
Main power ON/OFF switch  
(SS-22H03 G7)



TK-EC010  
触发开关  
(Airsoft) Shooting unit # 1  
(Recoil switch)



TK-EC013E  
PH-3P插座  
PH-3P socket  
IR6.0



TK-EC042  
红外线接收器  
Infrared receiver  
IR6.0



TK-EC018  
05mm 红外线发射管  
05mm Infrared transmitting tube



TK-EC015A  
03mm LED (白灯发红光)  
03mm LED (white LED shine  
red light)



TK-EC017  
05mm LED (白灯发白光)  
05mm LED (white LED shine  
white light)



TK-EC017A  
05mm LED (白灯发红光)  
05mm LED (white LED shine  
red light)



TK-EC021  
KET 电源线(120mm)  
2 ports single head cable(120mm)



TK-EC022  
单向2P插头线(02.1 180/270 mm)  
2 ports single head cable  
(02.1 180/270 mm)



TK-EC023  
单向2P插头线(01.0 150/180mm)  
2 ports single head cable  
(01.0 150/180mm)



TK-EC024  
单向2P插头线(01.0 320/430 mm)  
2 ports single head cable  
(01.0 320/430 mm)



TK-EC054  
单向3P插头线(01.0 220/420 mm)  
3 ports single head cable  
(01.0 220/420 mm)



TK-EC055  
杜邦2P插头线(01.0 150/350/420mm)  
DuPont 2 ports single head cable  
(01.0 150/350/420mm)

## 电气零件表 (ELECTRONIC PARTS)

TK-EC028

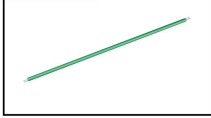

连接线(红)90/150/310/330mm  
Connect line (red)  
90/150/310/330mm

TK-EC029

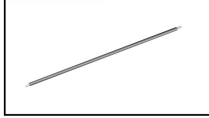

连接线(黑)90/150/310/330mm  
Connect line (black)  
90/150/310/330mm

TK-EC033



SC 7.2V 电池 Ni-MH 2000mAh  
SC 7.2V battery Ni-MH 2000mAh

TK-EC034



SC 7.2V 电池 Ni-MH 3000mAh  
SC 7.2V battery Ni-MH 3000mAh

TK-EC036B



7.4V 锂电池(双插头)  
7.4V Li-ion battery (Double plug)

TK-EC053



7.4V 充电器(平衡充)  
7.4V Charger (Balance charger)

TK-EC035C



标准  
Standard  
7.4V 锂电池(带智能保护板)  
7.4V Li-ion battery (Built-in battery intelligent protective board)

TK-EC035D



标准  
Standard  
7.4V 锂电池(带智能保护板)  
7.4V Li-ion battery (Built-in battery intelligent protective board)

TK-EC053B



USB 充电线(专用)  
USB Charge line (Special)

TK-EC053C

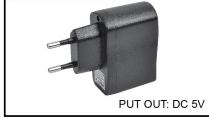

USB 变压器  
USB Transformer

TK-EC041D



遥控器(2.4GHz)  
Remote controller  
(Smoking edition 2.4GHz)

## 其它配件表 (OTHER PARTS)

TK-AC001



BB弹 6mm BB Ball bullet

TK-AC002A



烟雾剂 Aerosol

TK-AC003A



机关枪 Machine gun barrel

TK-AC004A



指挥官 Commander

TK-AC005



配件盒 ACCESSORY BOX

TK-AC006



Φ1mm-Φ4mm 热缩管  
Φ1mm-Φ4mm Heat-shrinkable tube

TK-AC007



橡皮塞  
Rubber stopper

TK-AC008



PVC垫  
PVC Mat

TK-AC009



靶板 Target

TK-PT3838



贴纸 Paste

3838-AC001C



说明书 Instruction manual

## <升级选购件><Hop-up optional parts>

下列是可供选择的升级选购件，可通过当地的经销商购买配件。  
The following are optional parts for upgrading can be purchased through local dealers.

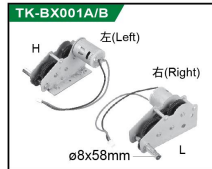

TK-BX001A/B  
金属齿轮驱动箱(锌合金/钢质齿轮)  
Metal gear drive box (Zinc alloy / Steel gear Tank operator)

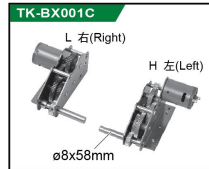

TK-BX001C  
终极版驱动波箱(全轴轴承、钢质齿轮)  
Ultimate edition drive ultimate box (Full shaft bearing, Steel gear)

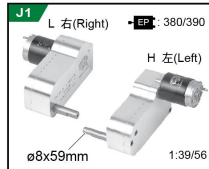

J1  
CNC驱动波箱(“匠”系列)  
CNC drive gear box (“Craftsman”series)



TK-MC3838  
金属履带  
Metal caterpillar

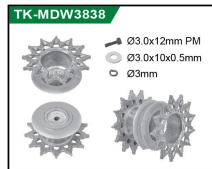

TK-MDW3838  
金属驱动轮(含螺丝、弹垫)  
Metal driving wheel(Included screws, spring mat)

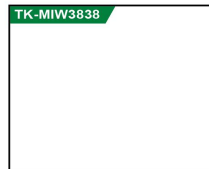

TK-MIW3838  
金属诱导轮(轴承)  
Metal idler(Bearing)

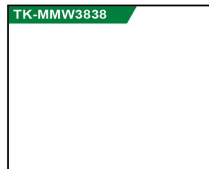

TK-MMW3838  
金属主轮(轴承)  
Metal main wheel(Bearing)

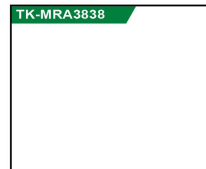

TK-MRA3838  
金属摇臂  
Metal rocker arm



TK-HC3838  
轮罩(主轮)  
Hub cap(Main wheel)

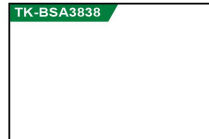

TK-BSA3838  
驱动轴轴承座组件  
Bearing seat assembly of drive shaft



CR-TL006  
螺丝刀(六角 $\phi 1.5\text{mm}$ )  
Screwdriver(Hexagon  $\phi 1.5\text{mm}$ )



TK-BSM380A  
高速碳刷电机  
High-speed carbon brush motor

### 驱动轴加装轴承安装方法 HOW TO INSTALL THE BEARING OF DRIVE SHAFT

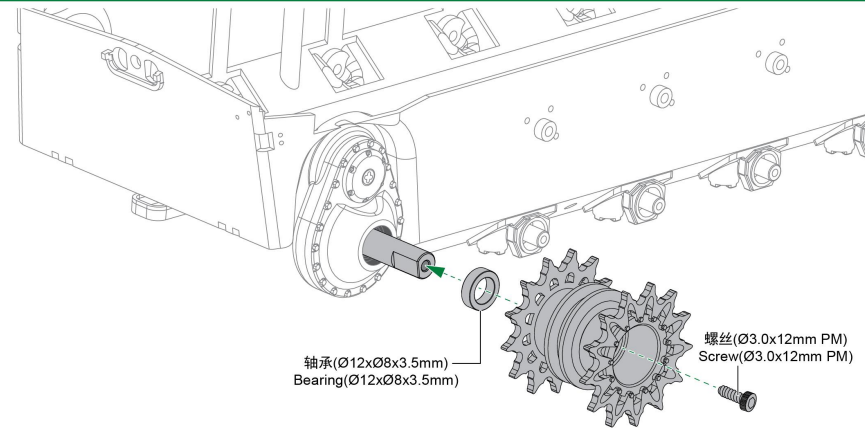

# U.S.M26 PERSHING 战车简介

## Tank Introduction



即使是在重视使用电子装备的信息战的今天，战场上互相追求高科技兵器的威力，但陆地战争起到主导作用的依然是坦克，它具有压倒性的强大装备，具有疾风怒涛般的机动性，具有令人畏惧的大炮毁灭力。坦克在全世界爱好者的中心，是梦寐以求的理想战斗机器。

过去，有数以千计的仿真坦克被制造出来，受到全球几代人的喜爱；有木制的、塑料的、带马达的、有线式的、无线控制的等等。这不计其数的坦克使人们的梦想得以实现。今天，在这辉煌的历史中，提出了“最新的，具有纪念意义的新一页！”的口号，作为研制开发的指南。

这种结果就实现了超逼真的外观。与1/35、1/60这两种原来的模式相比，1/16这种模式远远地超越了它们。它实现了大型化，在细节上也能忠实地模仿原来的样式，而且1/16这种尺寸是公认的国际规格。由于与其他多数的车模尺寸相同，它们与本品同时展出可以衬托出“U.S.M26 PERSHING”战车的存在感和逼真形象。

第1个销售的卖点是它的行走性能，作为现代的最新型战车，“U.S.M26 PERSHING”动作敏捷，能够挑战遥控车的极限。前进、后退、左转和右转就不用说了，作为坦克特征的履带动作、信地旋回、超信地旋回也可以实现，坦克使用全比例遥控，前进后退速度可自由控制，让我们领略各种方式行走的乐趣。

第2个销售的卖点是炮塔能够左右旋转、炮身上下运动。这样，就与实物一样能够准确地对准目标而不会漏掉！主炮是正式的电动炮（具有弹道改良系统）BB弹的射击距离约25米，而且与实物同样是自动装填式的。

第3个销售卖点是它的仿真声、启动点火马达声、发动机声、发炮声及发炮振动、机关枪声、发动机熄火声及冒烟功能，使操作者身临其境。

当BB弹发射时，“U.S.M26 PERSHING”战车的“直接瞄准孔”上安装的红色“BB弹发射警告灯”就会亮起来，以防止无意间误发射。同时，让坦克像活物一样具有表情（好像瞄准猎物的猎手一样）！

“前进”“瞄准”“发射”实物战车具有的动作都能够实现，这就是最新高科技研制的战车的精髓！

色调和图案也能逼真地再现实物形状。迷彩喷涂和车体主要部件喷涂完成的机体和控制器使每个人都欣赏到行走和BB弹发射的妙趣。还有安装上了坦克长；今后陆续推出的各款新款配件都将使游戏更具情趣。

新感觉的遥控器操纵非常方便，所以边走边转向和发射BB弹的复合动作也会十分方便！电源则使用充电电池，控制器使用8粒AA电池。可实现连续30分钟的行走。由于可以更换不同的晶体，可以实现多台战车同时行走而不会互相干扰。这样你可以和他人或者朋友各自拿出自己最得意的战车来比赛，甚至进行战斗！

“创造、技术、品质！”是本公司面向21世纪的三个口号，而“1/16 RC战车系列”则完全和以上口号相吻合，本公司将致力于为车迷着想，为广大爱好者做出新贡献。

### Introduction of RC Battle Tank U.S.M26 PERSHING

Today, while modern war depends more and more on information and high-tech electronic equipment and electronic weapons, tanks still play a key role in ground wars. Well known for strong driving power and mass destructive gun, they are ideal weapon for military fans around the world.

During the past decades thousands of simulated tanks have been developed and been favoured by generations of people worldwide. Technology is gradually developed, starting from the first wood-made mold to motorized one then to wire-controlled one. Finally here come the wireless controlled molds. Now it is time for us to seek another breakthrough in the history of tank molds.

As a result of our research work, a whole new model, RC battle tank U.S.M26 PERSHING (1/16 scale) with vivid look, has made its debut on the market. Compared with the former models of 1/35 and 1/60 scales, it is much larger and simulates more details of a real tank. Besides, the commonly accepted scale of 1/16 makes it more real and outstanding if displayed together with other models of the same size.

The first sales point is its excellent maneuvering performance. As the latest modern tank, it has high agility and exceeds the limits of moves of traditional remote controlled cars. Except normal moves, such as forward run, backward run, left turn, and right turn, it can perform spin stunt and super spin stunt with caterpillars, which are unique and characteristic moves of a tank. Because the tank uses full scale R/C function, speed forward and speed backward can be controlled allodially.

The second sales point is that its turret can turn sideways and the gun can move up and down, imitating actual aiming acts of a tank. The powerful motor air gun (with hop-up system) can shoot BB bullets as far as 25m. What's more, the bullets can be loaded automatically, just like a real tank.

The third sales point is that its emulational music、simulative motor start-up sound、engine sound、machine-gun sound and cannonball sound, and smoking function, let the manipulator is personally on the scene.

There is a red indicator for BB bullet shooting near the direct aiming hole on the battle tank. It will light up before shooting, warning people of the shooting and making the tank more like a real hunter.

“Run forward! Aim! Shoot!” All these acts of a real battle tank can be performed by this simulated tank.

The color and pattern on the body of the model also perfectly resemble a real tank. The camouflage coating on the tank makes running and shooting more interesting. There is also a tank operator, designed to make the game more attractive. The handy-type controller is easy for use. Only one hand is enough when controlling basic moves of the tank. And you can also use it to control many complicated moves. For example, the tank runs and turns and shoots at the same time.

The tank is powered by rechargeable battery, while the controller uses eight AA batteries. If fully powered, the tank is run continuously for 30 minutes. Moreover, the tank can change different crystal for more than 1 tank to run at the same time without interference.

“Creativity, Technology, Quality” These are the 3 slogans of our company for the new century, which are embodied in our 1/16 RC battle tank series. In the future, we will try our best to offer you more quality products.