

# 2-Channels Intelligent Charger

For LiPo/LiFe/LiHv/Lilon/NiMH/NiCd/Pb batteries

# X<sup>mini</sup>



Include Intelligent power allocation and average power allocation.  
Single channel AC Power: Max 100W in intelligent allocation mode

- Charge Power: DC 200W / AC 100W
- Charge Current: MAX.10A\*2

power  
**200**  
watt



Thanks for purchasing GT Power X2mini Charger. This is a charger with built in microprocessor and newest program. This charger can support 2 channels charging, can charge 2 different battery types at the same time. This charger with fashion design, easy to operate. Please read the manual completely and carefully before using.

**G.T.POWER**<sup>®</sup>

## Contents

<b>1.Specifications</b> .....	<b>2</b>
<b>2.The exterior appearance of the unit</b> .....	<b>3</b>
<b>3. Warnings and safety notes</b> .....	<b>4</b>
<b>4. Program flow chart</b> .....	<b>6</b>
<b>5. Charging current setting</b> .....	<b>7</b>
<b>6. Power Allocation</b> .....	<b>7</b>
<b>7. Lithium Battery (LiLo/LiPo/LiFe/LiHv) Mode Instruction</b> .....	<b>8</b>
<b>8. Operation process</b> .....	<b>8</b>
<b>9. Cell meter test program</b> .....	<b>10</b>
<b>10. Data save program</b> .....	<b>10</b>
<b>11. Load data setting</b> .....	<b>11</b>
<b>12. User setting</b> .....	<b>11</b>
<b>13. Warning and error messages</b> .....	<b>13</b>
<b>14. Warranty and service</b> .....	<b>14</b>

## 1. Specifications

Input Voltage	AC.100-240V
	DC.19-26V
Charge Current	0.1-10.0A*2
Charge Power	AC.Max.100W
	DC.Max.100W*2
Balance Current	500mA
Balance Precision	±0.01V
Charging Capability	LiPo/LiFe/LiIon/LiHv: 1-4cells
	NiMH/NiCd: 1-8cells
	Pb: 2-14V
Weight	554g
Dimensions	137.5*141.5*55.5mm

## 2.The exterior appearance of the unit

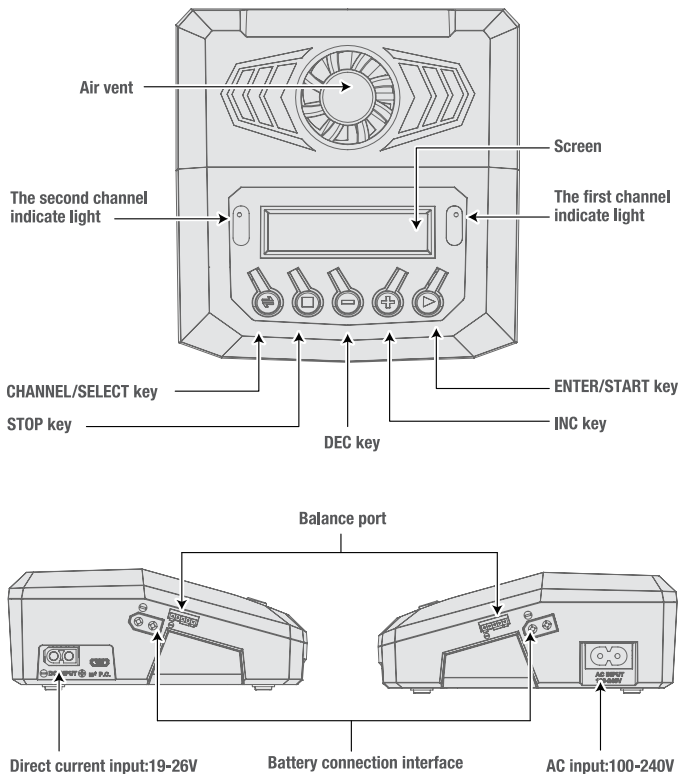

### 3. Warnings and safety notes

- Never leave the charger unsupervised when it is connected to power. If any malfunction happens, terminate the program immediately and refer to the operation manual for the right operation.
- Keep the unit away from dust, damp, rain, heat, direct sunshine and vibration. Do not drop it.
- The circuit of the unit is designed to be powered by 100-240V AC or 19-26V DC.

<b>NiCd/ NiMH</b>	voltage level: allowable fast charge current: discharge voltage cut off level:	1.2V/cell 1C~2C depends on the performance of cell 0.85V/cell(NiCd), 1.0V/cell(NiMH)
<b>Lilon</b>	voltage level: max.charge voltage: allowable fast charge current: min.discharge voltage cut off level:	3.6V/cell 4.1V/cell 1C or less 2.5V/cell or higher
<b>LiPo</b>	voltage level: max.charge voltage: allowable fast charge current: discharge voltage cut off level:	3.7V/cell 4.2V/cell 1C or less 3.0V/cell or higher
<b>LiFe</b>	voltage level: max.charge voltage: allowable fast charge current: discharge voltage cut off level:	3.3V/cell 3.6V/cell 4C or less(e.g. A123M1) 2.0V/cell or higher
<b>LiHV</b>	voltage level: max.charge voltage: allowable fast charge current: min.discharge voltage cut off level:	3.8V/cell 4.35V/cell 1C or less 3.0V/cell or higher
<b>Pb (Lead- acid)</b>	voltage level: max.charge voltage: allowable fast charge current: discharge voltage cut off level:	2.0V/cell(Lead-acid) 2.46V/cell 0.4C or less 1.50V/cell or higher

- The charger and the battery to be charged should be set up on a heat-resistant, non-flammable and non-conductive surface.
- Please ensure that the fan and vents of the charger are not blocked by the surface that it is placed on.
- Make sure you understand the correct settings to use for the battery to be charged or discharged. Use of incorrect settings may cause severe damage to the battery, including possible fire or explosion.
- To avoid short circuit between the charge leads, always ensure the leads are connected to the charger first and only then plugged into the battery. Always make sure that no batteries are connected to leads before disconnecting them from the charger.
- You have to pay attention to verify the capacity and the voltage of the Lithium battery pack. It may be composed of parallel and series connection mixed. In parallel link the capacity of the battery pack is multiplied by the number of cells but the voltage remains the same. That kind of voltage imbalance may cause a fire or explosion during charge process. We recommend you compose the Lithium battery pack in series only.

**The above warnings and safety note are particularly important, please follow the instructions for a maximum safety, any improper operation may cause severe damage to charger and batteries, including possible fire or explosion.**

## 4. Program flow chart

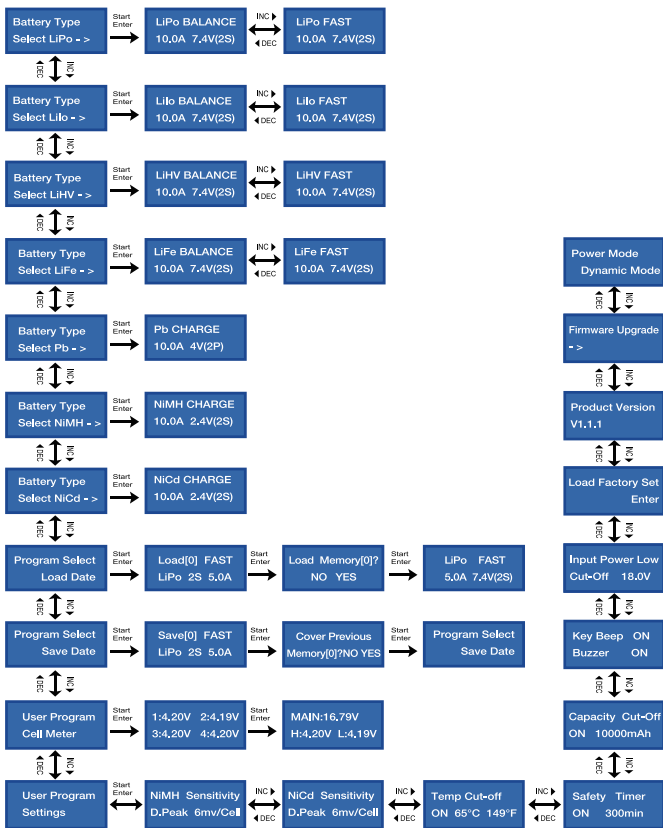

## 5. Charging current setting

You have to know the battery allowable maximum charge current before charging. Charge current exceeds the allowable maximum charge current may cause damage to battery and it is possible to lead a fire and explosion of battery when charging.

We usually use C value to mark battery charging/discharging capability. The battery allowable maximum charging current is calculated by multiply C value by battery capacity. For example, if battery is 1000mAh, 5C, then the allowable maximum charging current is  $1000 * 5 = 5000\text{mA}$ , that is the battery maximum allowable charging current is 5A.

To Lithium batteries, if you can't confirm battery's C value, for your safety, please set charging current no more than 1C.

The relationship between C value and charging time is, charging time  $\geq 60\text{minutes}/\text{C value}$ , for example, charging with 1C, charging finish time need 60-70 minutes. This time may be extended due to different battery performance.

## 6. Power Allocation

Power allocation is only effective under AC power supply, have intelligent allocation and average allocation two modes.

Power Intelligent allocation is allocate power by channels, it can improve charger's working efficiency, shorten charging time, with intelligent allocation design to meet different user's needs.

Single channel working power can reach to 100W under AC input mode. Charger is charged by full power per single channel according to the priority of charging start time. That is when 2 channels all connected with battery and start charging process, charger will allocate full power to the battery which charging first, allocate the other channels with small power. When the first battery fully charged, then one by one according to the charge time priority to full power charge each channel battery till every single channel battery fully charged.

Power average allocation is to allocate the power of charger equally to each channel, each channel's power is the same, minimum 50W, maximum 100W. This design is good for record charging time and compare battery performance.



Under DC input mode, each channel can charge under maximum power 100W, improve charging efficiency and shorten charging time.

## 7. Lithium Battery (LiLo/LiPo/LiFe/LiHv) Mode Instruction

### Charging Lithium battery at balance mode

This is for balancing the voltages of Lithium batteries of the battery pack to be charged. Inner system will monitor each cell's voltage and restraint each cell's current to fulfill balance charging. You need to connect the battery to the charger's output plug as well as the balance port when charging.

### "FAST" charging Lithium battery

The charging current is getting smaller as the charging process goes to the end. To finish charging process earlier, this program eliminated certain CV process and balancing process. The fact is when the charging current goes down to 1/5 of the initial value can finish charging process. Under this situation the charging capacity may smaller than the charging capacity under normal charging, but reduced the charging time.

## 8. Operation process

This charger has two channels function, each channel operation process is the same, below use the first channel to illustrate the operation process.

When channel led light constantly lights, you can switch channel and system setting program by **CHANNEL/SELECT** key.

After choose the right channel, press **ENTER** key and through press **DEC** or **INC** key to choose battery type, including LiPo、LiFe、Liion、LiHV、NiMH、NiCD、PB batteries. Or you can start program setting, voltage test, data storage.

### **Warning**

**This LiHV mode can only support 4.35V Lithium battery, forbidden to use other batteries to charge under this mode. Charge LiPo/Liion/LiFe or other batteries voltage under 4.20V in LiHV mode may cause possible fire or explosion.**

Press **STOP** key Back to the last interface, then press **ENTER** key to the next menu.

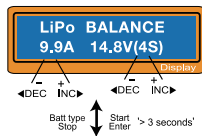

Choose the right program, press **ENTER** key to choose balance charging mode or fast charging mode enter into next program, back press **STOP** key.

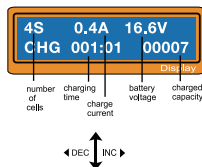

Shortly press **ENTER** key to current setting. Through press **INC/DEC** key to set current, range from 0.1-10A, shortly press **ENTER** key again, then through press **INC/DEC** key to set battery counts:3.7V(1S)-14.8V(4S). After finished, long press **ENTER** key to charging program.

Press **STOP** key back to last menu, then press **ENTER** key to start program.



Press **INC** key to show each single cell battery.

Press **DEC** key to show charge power, battery capacity and charger's inner temperature..

Press **STOP** key and confirm exit to stop current program and back to last menu.

## 9. Cell meter test program

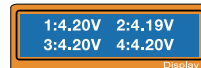

This charger with built-in high-bit micro-processor, can be used as a cell meter. It can show the voltage of each cell, the total battery pack voltage and the highest/lowest voltage.

Choose the cell meter program interface, press **START** to enter.

Press **START** key to show the highest/lowest voltage of the single cell and the total voltage of the battery pack.

press **START** to show 1-4 cells voltage. Press **STOP** key back to main menu.

## 10. Data save program

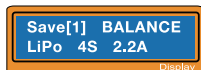

It has a data storage and load program, can store up to 10 battery data by number that represent the individual specification of the batteries you are using. They can be called back for charging/discharging process without setting the program again.

Set the battery parameters in the battery type program you need to save. Use 3s lipo battery as example, you need choose Lipo charge program first, then set lipo battery parameters, after parameter set finished, exit this program and select data saving program. Select the shortcut number that you want to save for the next time use, then press **ENTER** key enter into the data saving interface.

press **ENTER** key to save data.

## 11. Load data setting

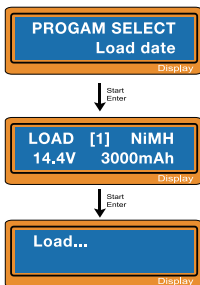

This program calls back the data that was stored at 'Save Data' program. To load the data, press **Start/Enter** key once to blink the data number field and select the number using **INC** or **DEC** key then press **Start/Enter** key for more than 3 seconds.

As indicated, choose [01] NIMH, will show corresponded value 14.4V3000MA

## 12. User setting

When you used it for the first time, it will operate according to the preset value. You can modify parameters in the Settings column for the second time use.

### Automatic charging trigger voltage program

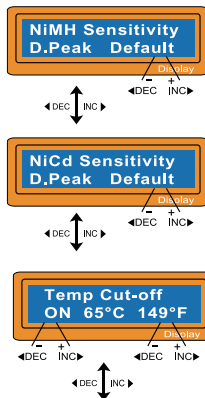

The automatic charging trigger voltage program is a kind of program that can automatically turn off the charging current during charging. The working principle is that after the battery voltage increased to the maximum value and start to decreasing then the charge current will turn off and finish the charge. If the trigger voltage set too high, there is a possible danger of over-charging. If the trigger voltage set too low, may stop charging prematurely. Please refer to the specification of the battery (NiCd default voltage:12mv, NiMH default voltage:7mv).

### Temp cut-off program

Temp cut-off program is used to protect charger being damaged. Will trigger stop charge/discharge when in extreme or high temperature environment. Temperature cut off value can set from 60° to 80°.

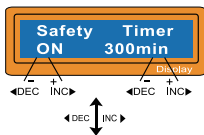

### Safety time setting

If you turn on safety timer, safety timer will start timing when charging. If system fault or system can't identify battery capacity already full, this safety time set can stop battery being over charged. The safety time should not shorter than the time battery fully charged, usually from 10min to 720min.

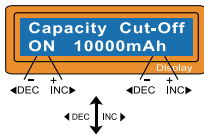

### Capacity cut-off program

Capacity cut-off program set the maximum charging capacity. If safety timer stopped work or system can't detect the peak voltage, this program will stop charging/ discharging automatically if you've set the maximum charging capacity, range from 10mAh to 50000mAh. .

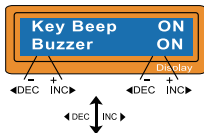

### Sound setting

Beep sound on/off; Buzzer sound on/off.

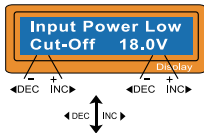

### Input Power low cut-off

DC input power is 19-26V, the program set the lowest cut-off input voltage value is 19-26V. If the voltage lower than the setting voltage level, procedure will be forced to end to protect input power.

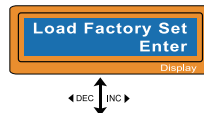

### Load factory set

Resume to the default setting



### Product version

This is used to check product version



## Firmware upgrade

Press **ENTER** key to do firmware upgrade

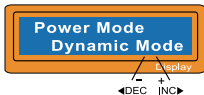

## Power Allocation

Under AC power supply, you can choose the power allocation mode, intelligent allocation or average allocation.

First priority: intelligent allocation.

Dynamic Mode: average allocation.

## 13. Warning and error messages

It will show the Error information with a beep sound when operation error.

### 1. {" BATTERY CONNECT ERROR "}

Interruption of battery and output end, or the charger wire has not been connected well when charging or discharging

### 2. {" INPUT VOLTAGE FLUCTUATION "}

Input voltage fluctuation range over 1V, please check input power to ensure input voltage fluctuation range not exceeds the normal allowable range.

### 3. {"BATTERY VOL ERR CELL CONNECT"}

unit battery voltage error, please check the battery voltage one by one.

### 4. {" TEMP OVER ERR "}

The internal temperature of the unit goes too high, you need to cooling down the unit

### 5. {" SHORT CIRCUIT ERROR"}

Short circuit, you need to check charge circuit and related equipment.

### 6. {"CAP OUT "}

Over the charger's capacity protection set value, you need to check and reset the capacity protection value.

### 7. {"INPUT VOLTAGE ERROR"}

Input voltage error, you need to check the input power to make sure the input power correct.

### 8. {"REVERSE PLOARITY"}

Battery output polarity connection wrong, you need to reverse connected battery polarity.

### 9. {"SAFETY TIME OUT!"}

You need to reset the safety charge time.

## 14. Warranty and service

We warrant this product for a period of one year(12 months) from the date of purchase. The guarantee applies only to such material or operational defects, which are present at the time of purchasing the product. During that period, we will replace without service charge for any product deemed defective due to those causes. You will be required to present proof of purchase(invoice or receipt). This warranty does not cover the damage due to wear, overloading, incompetent handling or using of incorrect accessories.

### CONFORMITY DECLARATION

G.T.POWER X2mini satisfies all relevant and mandatory CE directives and FCC Part 15 Subpart B. The product has been tested to meet the following technical standards:

	Test Standards	Title	Result
CE-LVD	EN60335-2-29	Household and similar electrical appliances – Safety – Part 2-29: Particular requirements for battery chargers.	Conform
	EN 60335-1	Household and similar electrical appliances - Safety - Part 1: General requirements	Conform
CE-EMC	EN55014-1	Electromagnetic compatibility – Requirements for household appliances, electric tools and similar apparatus – Part 1: Emission	Conform
	EN55014-2	Electromagnetic compatibility – Requirements for household appliances, electric tools and similar apparatus – Part 2: Immunity Product Family Standard	Conform
	EN61000-3-2	Electromagnetic compatibility (EMC) – Part 3-2: – Limits for harmonic current emissions (equipment input current up to and including 16 A per phase)	Conform
	EN61000-3-3	Electromagnetic compatibility (EMC) - Part 3-3: Limitation of voltage supply systems for equipment with rated current ≤ 16A.	Conform
FCC-VOC	FCC Part 15B	Title 47 Telecommunication PART 15 - RADIO FREQUENCY DEVICES Subpart B - Unintentional Radiators	Conform



**WARNING!**



**FIRE HAZARD!**

#### **NEVER USE CHARGER UNSUPERVISED!**

- Batteries pose a SEVERE risk of fire if not properly handled.
- Read Entire operation manual before using charger.
- This unit may emit heat during use.
- Only operate this device in a cool ventilated area away from flammable objects.
- Failure to observe safety procedures may cause damages to property or injury.

# G.T.POWER<sup>®</sup>

