

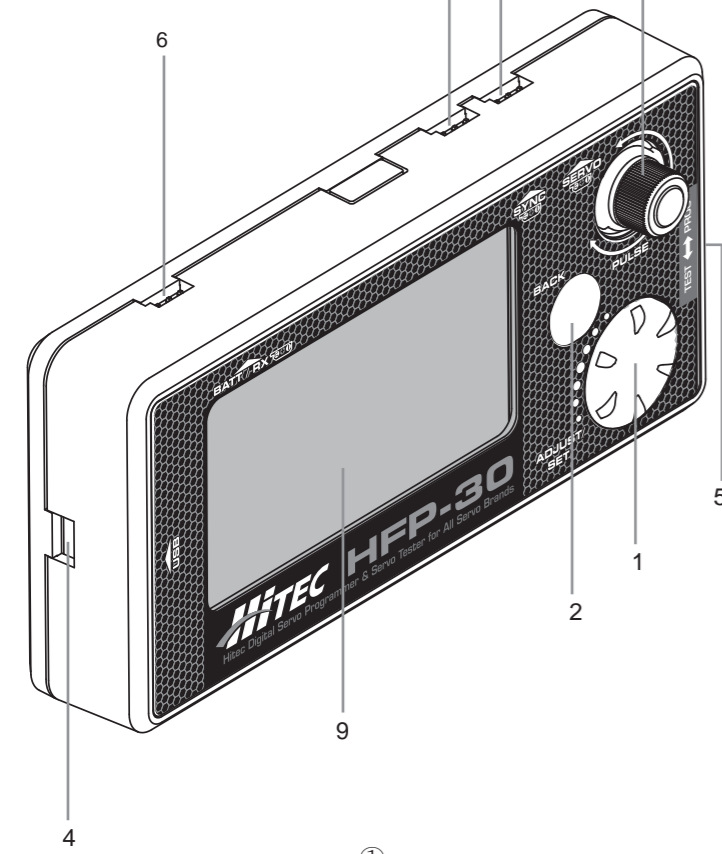

Instruction
Thank you for purchasing HFP-30 Hitec Digital Servo Programmer & Servo Tester.
HFP-30 is designed to program for all Hitec's programmable servos (Brushless, 5000/7000 Series and D Series).
Additionally, you can test any brand of R/C servo in the market by HFP-30.

- Guide Line**
1. Jog Dial (ADJUST, SET)
 2. Back Button
 3. Analog Dial for Pulse Adjustment
 4. USB Port
 5. Test/Program Select Switch
 6. Connection Port for Battery/RX
 7. Sync Port
 8. Servo Port
 9. LCD



Program

D Series Program Mode

- Set EPA/ Neutral
- Set CW or CCW
- Set Dead band Width
- Set Speed
- Set Servo ID
- Set Fail-safe
- Set Soft Start
- Set Factory Default

5XXX / 7XXX Series Program Mode

- Set EPA/ Neutral
- Set CW or CCW
- Set Dead band Width
- Set olution
- Set Overload Protection
- Set Factory Default

BLDC Series Program Mode

- Set EPA/ Neutral
- Set CW or CCW
- Set Dead band Width
- Set Speed
- Set Fail-safe
- Set Soft Start
- Set Factory Default

Test Mode Set Up

- Manual Test
- Auto Test
- Auto Dead Band Test
- Setting

Main Screen



You can select servo from this screen.

Main Screen of Servo Test Mode

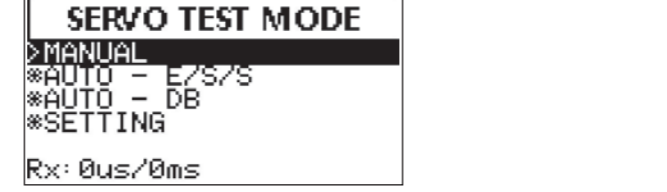

You can choice various test from this screen.

D Series Program Mode



Connect 3.5-8.4V battery to BATT/RX port ahead.
Connect D series servo to "Servo" port and select "D" on above screen.

1. Set EAP/Neutral



- 1) Press Jog Dial and select EPA/Neutral.
- 2) To change Pulse, Dial must be in neutral position.
- 3) To be activated, press Jog Dial. And turn the analog dial to desired position then press Jog dial to confirm.
- 4) LEFT : Press Jog Dial to activate function. And turn the analog dial to desired position then press Jog dial to confirm.
- 5) Right : Press Jog Dial to activate function. And turn the analog dial to desired position then press Jog dial to confirm.
- 6) Press "Back" button to escape the menu.

Tip
"Sync" is very useful to set EPA of 2 servos at the same time on a Giant scale plane.
1. Set EPA for standard servo ahead.
2. Once EPA set up of standard servo is done, connect it to Sync port.
3. Connect another servo to "Servo" port, and set EPA for another servo.
Once you do, two servo will be matched easily.

Tip
When you set EPA, servo must be detached from the linkage.

Warning
Once set up is completed, please escape the menu by pressing 'Back Button'.
If you do not escape by 'Back button' all set up information will not be stored.

2. Set CW/CCW

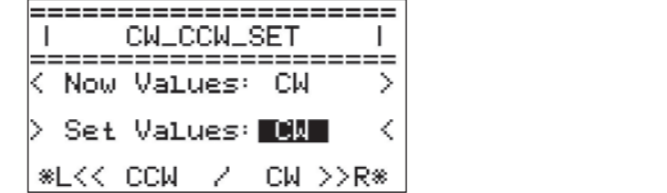

- 1) Select CW_CCW by turning the Jog Dial and press it to confirm.
- 2) Set CW or CCW by turning the Jog Dial and press it to confirm.
- 3) Press "Back" button to escape the menu.

3. Set Dead Band Width



- 1) Select DB_Width by turning the Jog Dial and press it to confirm.
- 2) Set desire value by turning the Jog Dial and press it to confirm.
- 3) Press "Back" button to escape the menu.

4. Set Speed

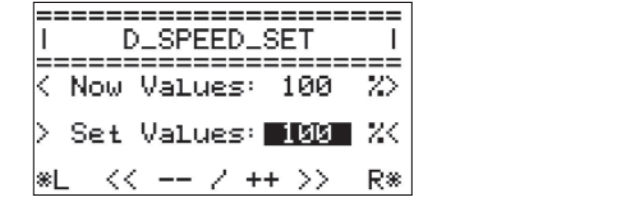

- 1) Select Speed by turning the Jog Dial and press it to confirm.
- 2) Set desire value by turning the Jog Dial and press it to confirm.
- 3) Press "Back" button to escape the menu.

5. Set Fail Safe



- 1) Select FailSafe by turning the Jog Dial and press it to confirm.
- 2) Turn the Analog Dial to be center (Neutral).
- 3) Set desire value by turning the Analog Dial.
- 4) Set On/off by turning Jog Dial and press it to confirm.
- 5) Press "Back" button to escape the menu.

6. Set Soft Start

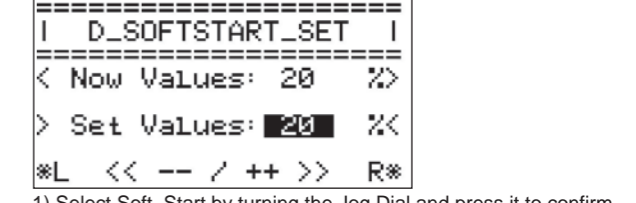

- 1) Select Soft_Start by turning the Jog Dial and press it to confirm.
- 2) Set desire value by turning the Jog Dial and press it to confirm.
- 3) Press "Back" button to escape the menu.

7. Set Factory Default

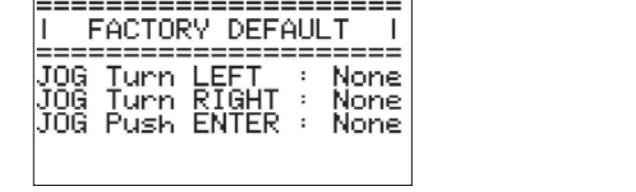

- 1) Select Factory Default by turning the Jog Dial and press it to confirm.
- 2) Turn the Jog Dial all the way to left and right, then press it to confirm.
- 3) Press "Back" button to escape the menu.

5XXX / 7XXX Series Program Mode

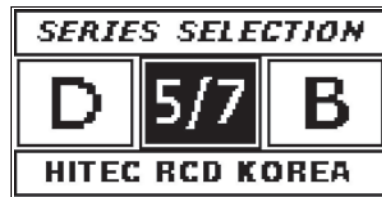

Connect 3.5~8.4V battery to BATT/RX port ahead.
Connect 5000/7000 series servo to "Servo" port and select "5/7" on above screen

1. Set EAP/Neutral

Please refer to D series

2. Set CW/CCW

Please refer to D series

3. Set Dead Band Width

Please refer to D series

4. Set Speed

Please refer to D series

5. Set Fail Safe

Please refer to D series

6. Set High Resolution

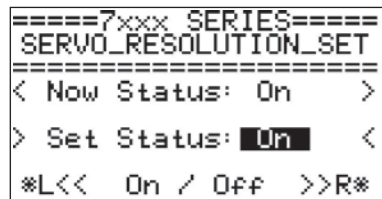

- 1) Select Servo_Resolution_Set by turning the Jog Dial and press it to confirm.
- 2) Set On/Off value by turning the Jog Dial and press it to confirm.
- 3) Press "Back" button to escape the menu.

7. Set Overload Protection

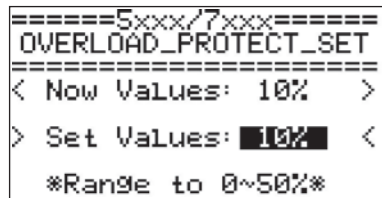

- 1) Select Overload Protection by turning the Jog Dial and press it to confirm.
- 2) Set desire value by turning the Jog Dial and press it to confirm.
- 3) Press "Back" button to escape the menu.

8. Set Factory Default

Please refer to D series

BLDC Series Program Mode

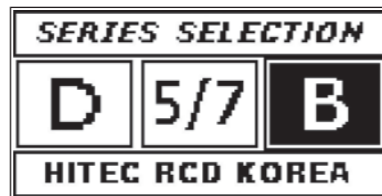

Connect 3.5~8.4V battery to BATT/RX port ahead.
Connect BLDC servo to "Servo" port and select "B" on above screen.

1. Set EAP/Neutral

- 1) Press Jog Dial and select EPA/Neutral.
- 2) To change Pulse, Dial must be in neutral position.
- 3) To be activated, press Jog Dial. And turn the Analog Dial to desired position then press Jog dial to confirm.
- 4) LEFT : Press Jog Dial to activate the function.
Turn the Analog Dial all the way to the Left and move to desired position then press Jog dial to confirm.
- 5) Right : Press Jog Dial to activate the function.
Turn the Analog Dial all the way to the Right and move to desired position then press Jog dial to confirm.
- 6) Press "Back" button to escape the menu.

2. Set CW/CCW

Please refer to D series

3. Set Dead Band Width

Please refer to D series

4. Set Speed

Please refer to D series

5. Set Fail Safe

Please refer to D series

6. Set Soft Start

Please refer to D series

7. Set Factory Default

Please refer to D series

Test Mode Set Up

Move Test & PROG switch to Test Mode.

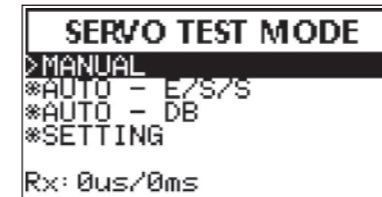

1. Basic Operation Test (Manual)



- 1) Turn the jog dial and select "Manual" by pressing the dial to confirm.
- 2) It is possible to test a servo by using the analog dial.
- 3) Select "STEP" and press the jog dial to activate.
It is possible to change the pulse value minutely.
(Press the jog dial again to escape)
- 4) Pressing the jog dial to move the servo to the setup position of FAIL SAFE.
- 5) Press "Back" button to escape the menu.

2. Auto Operation Test (Auto - E/SS)



- 1) Turn the jog dial and select "Auto -E/S/S" by pressing the dial to confirm.
- 2) In the Auto Test Mode, functions can be selected by pressing Jog dial.
Ex) Extreme Mode
-Turn the Jog dial to Select servo operation speed and press the jog dial to confirm.
-During the test, operation speed can be adjusted by turning jog dial.
-During the test, Stop and Start can be done by pressing the jog dial.
- 3) Press "Back" button to escape the menu.

3. Auto Resolution Test (Auto - DB)

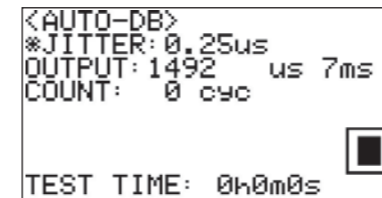

- 1) Turn the jog dial and select "Auto-DB" by pressing the dial to confirm.
- 2) Turn the jog dial to select "JITTER" value and pressing the dial to confirm.
- 3) During the test, operation speed can be adjusted by turning jog dial.
- 4) During the test, Stop and Start can be done by pressing the jog dial.
- 5) Press "Back" button to escape the menu.

4. Setting

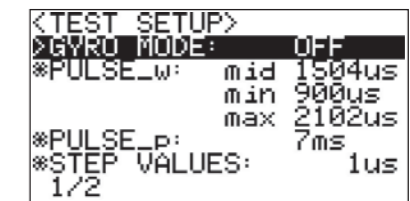

- 1) Turn the jog dial and select "TEST SETUP" from Auto - DB by pressing the dial to confirm.
- By pressing jog dial to select "Gyro Mode" and choice "On/Off" by turning the dial.
To confirm set-up, press jog dial once again.
(Gyro Mode in the test, operation range can be changed)
- 2) Turn the jog dial and select "PULSE_w" by pressing the dial to confirm.
- Mid :
Turn the jog dial to set a center position for the test.
Press jog dial to confirm.
- Min :
To activate function, press jog dial. And set all the way to the left position of servo by turn the jog dial. Press jog dial to confirm.
- Max :
To activate function, press jog dial. And set all the way to the right position of servo by turn the jog dial. Press jog dial to confirm.
- 3) Turn the jog dial and select "PULSE_p" by pressing the dial to confirm
- Change Frame Time by turning jog dial and press the dial to confirm.
(Please be aware that analog servo will be operation incorrectly in below 14ms condition)
- 4) Turn the jog dial and select "STEP VALES" by pressing the dial to confirm.
- Change Step value for test by turning jog dial and press the dial to confirm.
- 5) Turn the jog dial and select "TEST" by pressing the dial to confirm.
- Speed :
Press jog dial to activate function and select desire speed by turning jog dial.
Press jog dial to confirm.
- Count :
Press jog dial to activate function and select desire Count amount by turning jog dial.
Press jog dial to confirm.
- 6) Turn the jog dial and select "LCD Contrast" by pressing the dial to confirm.
- Turn the jog dial and select desire brightness by press jog dial.
Press jog dial to confirm.
- 7) Turn the jog dial and select "SET Default" by pressing the dial to confirm.
- Turn the jog dial and select default set or not by turning the dial.
Press jog dial to confirm.